

Electrohydraulics

FESTO

Basic Level TP 601
Textbook



Electro-hydraulics

Basic level

D. Merkle • K. Rupp • D. Scholz

ISBN 3-8127-3611-X

All rights reserved, including translation rights. No part of this publication may be reproduced or transmitted in any form or by any means, electronic, mechanical, photocopying, or otherwise, without the prior written permission of Festo Didactic KG.

© Copyright by Festo Didactic KG, D-73734 Esslingen, 1994

Order no.:	093611
Description:	E.-HYDR.LEHRB.
Designation:	D.LB-TP601-GB
Edition:	4/92
Graphics:	A. Reulecke
Layout:	16.6.93, C. Paproth, M. Schwarz
Editor:	A. Zimmermann
Authors:	D. Merke, K. Rupp, D. Scholz
Translator:	T. Tranter

Part A: Course

Conception of the book 6 Table of contents

1. Introduction 9

1.1 Advantages of electro-hydraulics 10

1.2 Fields of application of electro-hydraulics 10

1.3 Design of an electro-hydraulic system 11

2. Circuit and graphic symbols 13

2.1 Pumps and motors 14

2.2 Directional control valves 15

2.3 Pressure valves 16

2.4 Flow valves 18

2.5 Non-return valves 19

2.6 Cylinders 20

2.7 Energy transfer and preparation 22

2.8 Measuring instruments 23

2.9 Equipment combinations 23

2.10 Electrical circuit symbols 24

3. Electro-hydraulic control 27

3.1 Hydraulic circuit diagram 28

3.2 Electrical circuit diagram 32

3.3 Function diagram 35

3.4 Procedure for the construction of an electro-hydraulic system 39

4. Actuation of a single-acting cylinder 43

4.1 Exercise 1: Direct solenoid valve actuation (example: pressure roller) 45

4.2 Exercise 2: Indirect solenoid valve actuation (example: pressure roller) 50

4.3 Exercise 3: Boolean basic logic functions (example: tank forming press) 54

5. Actuation of a double-acting cylinder 63

5.1 Exercise 4: Signal reversal (example: tank forming press) 64

6. Logic operations 71

6.1 Exercise 5: Conjunction (AND function) and negation (NOT function) (example: plastic injection moulding machine) 72

6.2 Exercise 6: Disjunction (OR function) (example: boiler door) 77

6.3 Exercise 7: Exclusive OR (EXOR function) (example: assembly line) 81

7. Signal storage 85

7.1 Exercise 8: Signal storage in the hydraulic section
 (example: clamping device with double solenoid valve) .. 86

7.2 Exercise 9: Signal storage in the electrical section
 (example: clamping device with latching) 90

7.3 Speed control

Exercise 10: Flow control
 (example: reaming machine) 95

8. Sequence control system 101

8.1 Exercise 11: Pressure- and path-dependent sequence control
 (example: pressing device) 102

8.2 Exercise 12: Sequence control with automatic operation
 (example: milling machine) 107

Part B: Fundamentals

1. Electro-hydraulic system 113

1.1 Power section 114

1.2 Signal control section 115

1.3 Interface 115

2. Fundamentals of electrical engineering 117

2.1 Direct current and alternating current 118

2.2 DC circuit 119

2.3 Electromagnetism 122

2.4 Capacitance 123

2.5 Measurements in a circuit 124

3. Electrical components 127

3.1 Power supply unit 128

3.2 Electrical input elements 129

3.3 Sensors 131

3.4 Relay and contactor 137

3.5 Solenoids 140

3.6 Control cabinet 145

3.7 Voltage supply of an electro-hydraulic system 148

4. Safety recommendations 149

4.1 General safety recommendations 150

4.2 Safety recommendations for electro-hydraulic systems 150

4.3 Safety recommendations for electrical systems 152

Standards for electro-hydraulic systems 191

Index 195

Appendix

Exercise 1 158

Exercise 2 160

Exercise 3 162

Exercise 4 166

Exercise 5 170

Exercise 6 172

Exercise 7 174

Exercise 8 176

Exercise 9 178

Exercise 10 180

Exercise 11 182

Exercise 12 186

Part C: Solutions

This textbook forms part of the Training System for Automation and Communications from Festo Didactic KG. It is designed for seminar teaching as well as for independent study.

The book is divided into:

- Course, Part A,
- Fundamentals, Part B,
- and Solutions, Part C.

Part A: Course
The reader gains subject knowledge through examples and exercises. The subject topics are coordinated in terms of content and supplement one another. References draw the reader's attention to more detailed information on specific topics in the Fundamentals section.

Part B: Fundamentals
This section contains basic theoretical information on the subject. Subject topics are arranged in logical order. In this textbook, the emphasis is on the field of electrical components. The Fundamentals section can be studied chapter by chapter or used as a reference source.

Part C: Solutions

This section contains the solutions to the problems set in the Course section.

A list of the most important standards and a detailed index can be found in the appendix.

When using the textbook, readers will benefit from previous knowledge gained on hydraulic fundamentals, equipment and accessories at the level attained in the "Hydraulics" textbook (LB501) from Festo Didactic.

The textbook can be incorporated in existing training schedules.

Course

Part A





Introduction

Chapter 1



Hydraulic systems are used wherever high power concentration, good heat dissipation or extremely high forces are required.

Electro-hydraulic systems are made up of hydraulic and electrical components: The movements and forces are generated by hydraulic means (e.g. by cylinders).

Signal input and signal processing, on the other hand, are effected by electrical and electronic components (e.g. electromechanical switching elements or stored-program controls).

The use of electrical and electronic components in the control of hydraulic systems is advantageous for the following reasons:

- Electrical signals can be transmitted via cables quickly and easily and over great distances. Mechanical signal transmission (linkages, cable-pulls) or hydraulic signal transmission (tubes, pipes) are far more complex. This is the reason why electro-hydraulic systems are being used increasingly frequently in aeroplanes, for example.

- In the field of automation, signal processing is generally effected by electrical means. This enhances the options for the use of electro-hydraulic systems in automatic production operations (e.g. in a fully automatic pressing line for the manufacture of car wings).

- Many machines require complex control procedures (e.g. plastics processing). In such cases, an electrical control is often less complex and more economical than a mechanical or hydraulic control system.

Over the last 25 years, there has been rapid progress in the field of electrical control technology. The use of electrical controls has opened up many new fields of application for hydraulics.

Electro-hydraulics are used in a wide range of sectors, such as:

- the machine construction sector (feed systems for machine tools, force generators for presses and in the field of plastics processing),
- automobile construction (drive systems for production machines),
- aeroplane construction (landing flap operation, rudder operation),
- in shipbuilding (rudder operation).

1.2 Fields of application of electro-hydraulics

1.1 Advantages of electro-hydraulics

1.3 Design of an electro-hydraulic system

- signal control section with signal input, signal processing and control energy supply
- hydraulic power section with power supply section, power control section and drive section

Schematic design of an electro-hydraulic system

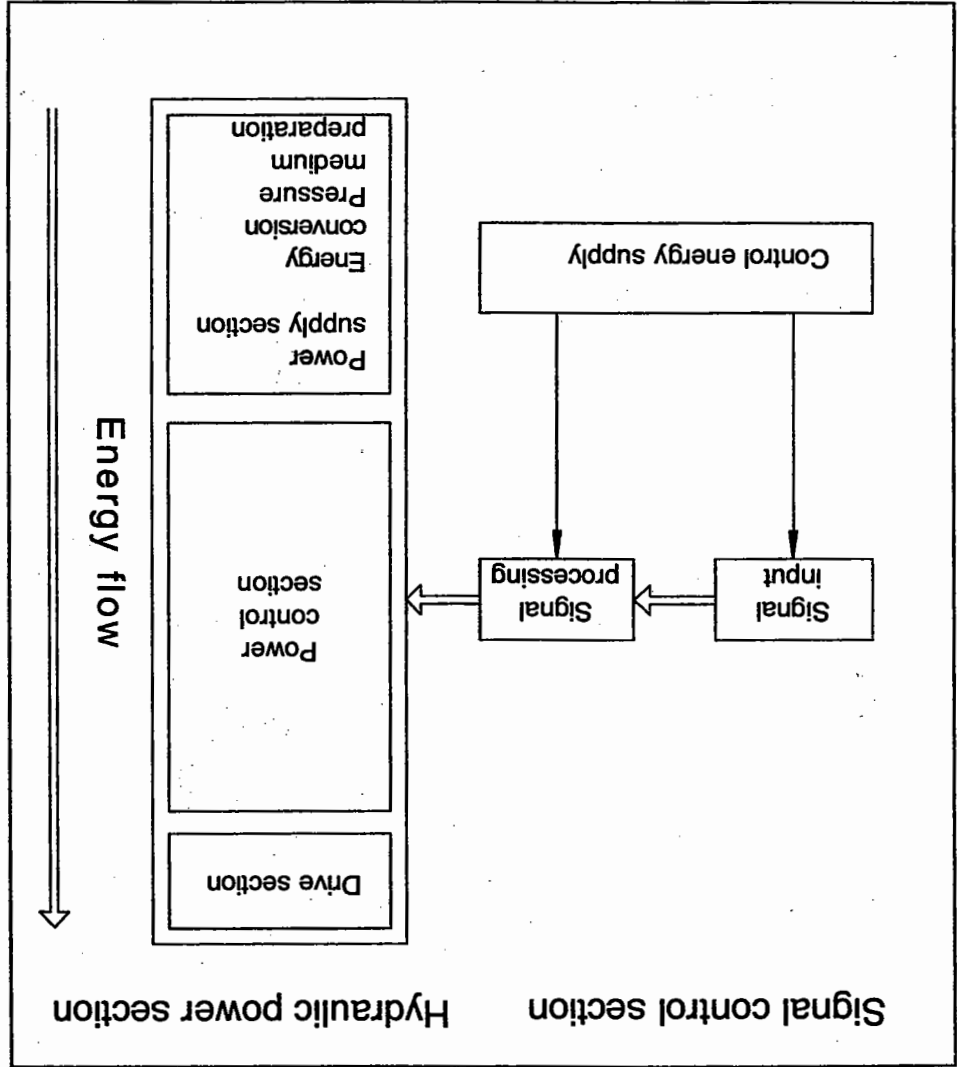

An electrical signal is generated in the signal control section, where it is processed and then transmitted to the power section via the interface. In the power section, this electrical energy is converted first into hydraulic and then mechanical energy.



Circuit and graphic symbols

Chapter 2



2.1 Pumps and motors

To simplify the presentation of electro-hydraulic systems in circuit diagrams, we use simple symbols (also called graphic and circuit symbols) for the various components. A symbol is used to identify a component and its function, but tells us nothing about the design of the component. **DIN ISO 1219** contains regulations on circuit symbols, while **DIN 40900** (Part 7) lists the graphic symbols for circuit documentation, and **DIN 40719** governs the letter symbols used for identification of the type of operating equipment. The most important graphic symbols are explained below. The functions of the components are described in the chapters in section B of this book.

Hydro pumps and hydraulic motors are represented by a circle with sketched-in drive and output shafts. Triangles in the circles provide information on the direction of flow. The symbols for the hydraulic motors only differ from the symbols for the hydro pumps in that the flow triangles point in the opposite direction.

Constant hydraulic motors and hydro pumps

Fluids ▼

Hydro pumps with constant displacement volume



with one direction of flow

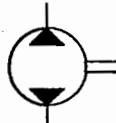

with two directions of flow

Hydraulic motors with constant displacement volume

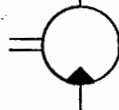

with one direction of rotation

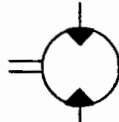

with two directions of rotation

2.2 Directional control valves

- Directional control valves are represented by a number of adjacent squares. The number of squares corresponds to the number of switching positions of a valve.
- The arrows in the squares show the direction of flow.
- The lines show how the ports are connected to one another in the various switching positions.
- There are two ways of designating the ports: either using the letters P, T, A, B and L, or continuously using A, B, C, D, ...; the first method generally being preferred.
- The designations of the ports always refer to the normal position of the valve. The normal position is the position to which the valve automatically reverts when the actuating force is removed. If the valve does not have a normal position, the designations are valid in the switching position which the valve adopts in the starting position of the system.
- In the designation of the directional valves, the number of ports is listed and then the number of switching positions. Thus a 3/2-way valve has three ports and two switching positions.

Further directional control valves and their circuit symbols are shown in the following diagram.

Directional control valves: designation and circuit symbols

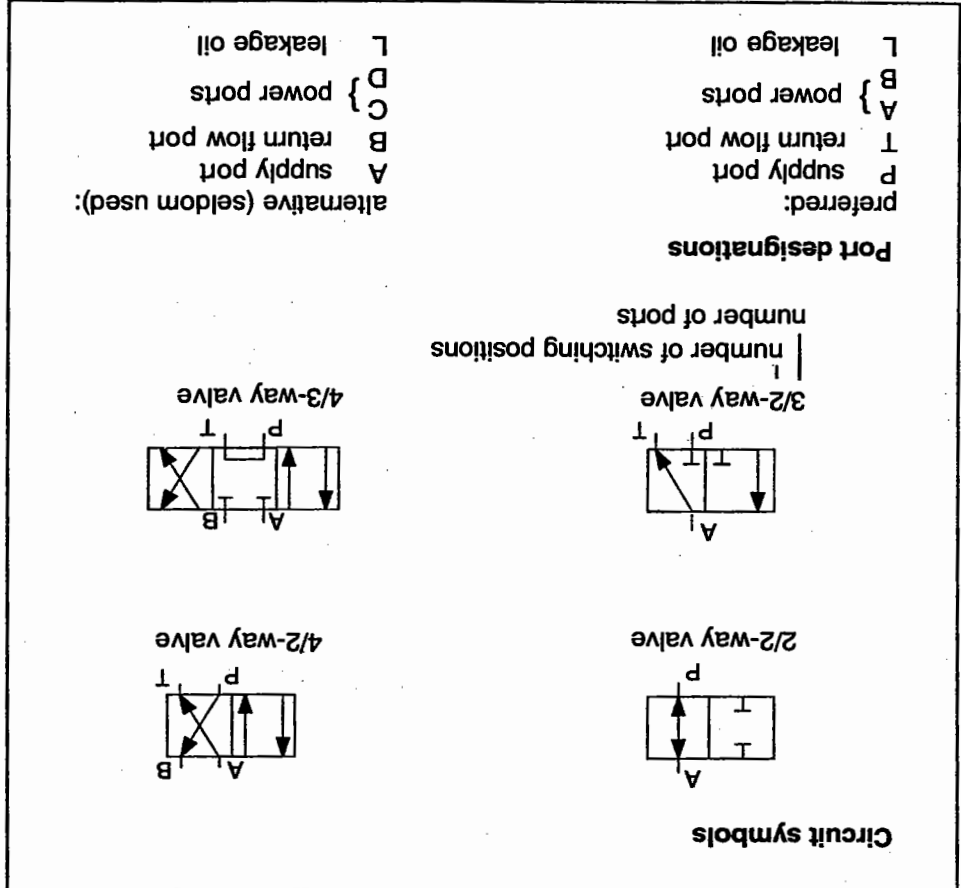

Actuation modes

Directional control valves are switched between the various positions by actuating elements. As there are various modes of actuation, the circuit symbol sign for a directional control valve must be supplemented by the symbol for actuation.

In electro-hydraulics the valves are actuated by an electric current. This current acts on a solenoid. The valves are either spring-returned, pulse-controlled or spring-centred. There follows a list of the symbols for the actuation modes used in this course; other possible actuation modes are listed in DIN ISO 1219.

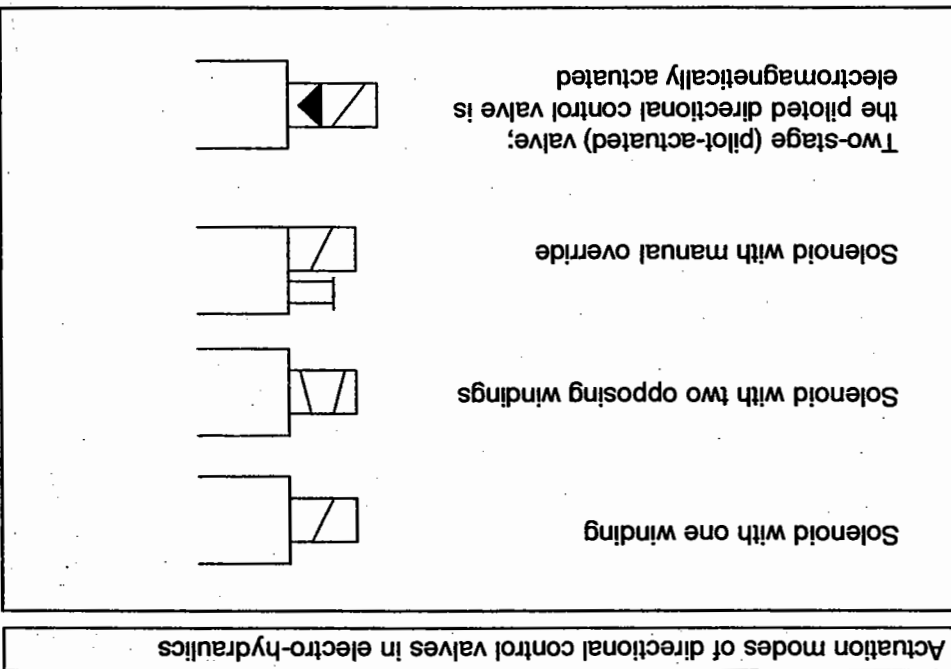

2.3 Pressure valves

Pressure valves serve to keep the pressure as constant as possible regardless of the flow rate. Pressure valves are represented by a square. An arrow shows the direction of flow. The ports of the valves can be designated using P (pressure) and T (tank port) or by A and B. The orientation of the arrow in the square shows whether the valve is open or closed in normal position.

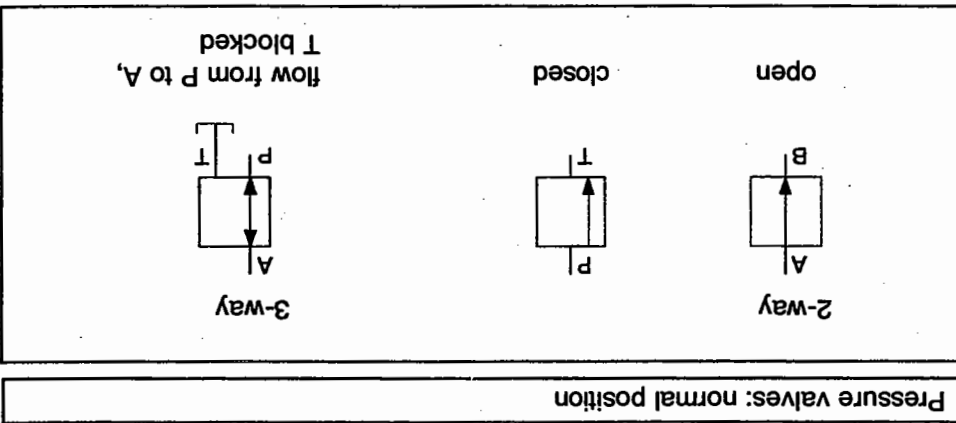

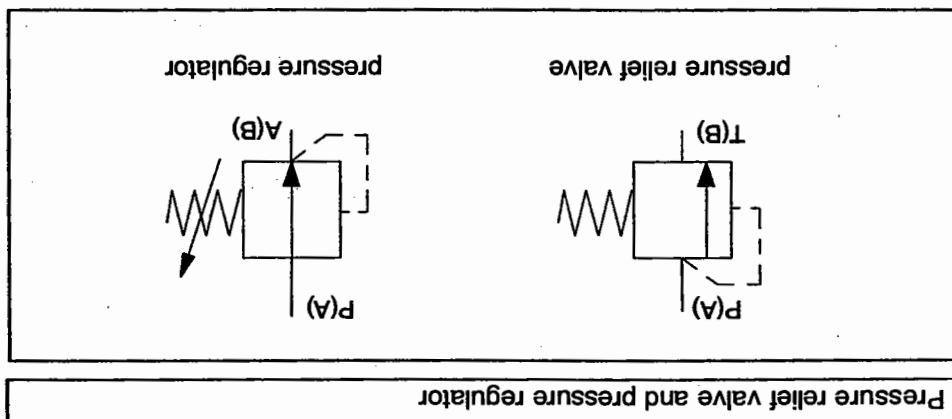

Pressure relief valve and pressure regulator

- Pressure valves are divided into pressure relief valves and pressure regulators:
- The pressure relief valve keeps the pressure at the port with the higher pressure (P(A)) almost constant.
 - The pressure regulator, on the other hand, ensures that the pressure at its A (B) port – in other words at the port with the lower pressure – remains almost constant.

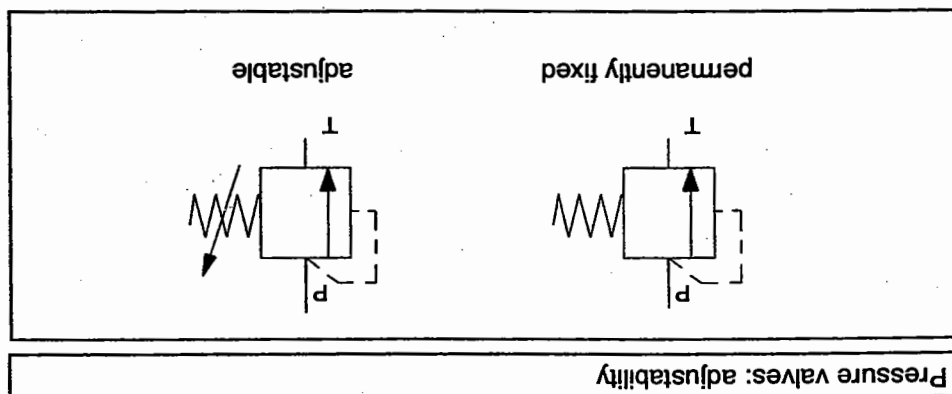

Pressure valves: adjustability

A further distinction is made between fixed and adjustable pressure valves. The latter are recognisable by an arrow running diagonally through the spring.

2.4 Flow valves

Flow control valve and flow regulator

Flow valves serve to reduce the flow rate in a hydraulic system. This is effected via flow restrictors which are called restrictors (throttles) or orifices. With restrictors, the flow rate depends on the viscosity of the pressure fluid, whilst this is not the case with orifices.

Flow valves are divided into flow control valves and flow regulators. Whilst with flow control valves the flow rate increases considerably with increasing pressure, the flow rate through flow regulators is almost entirely unaffected by pressure.

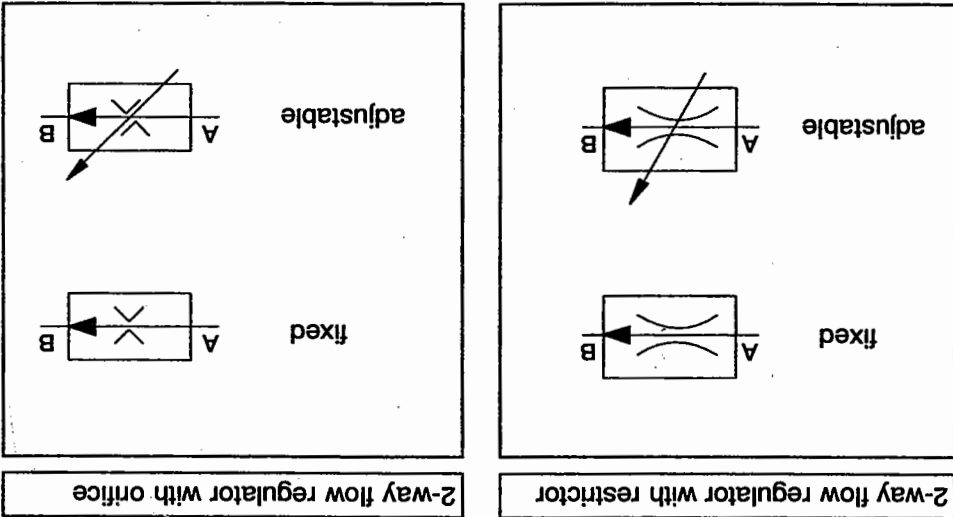
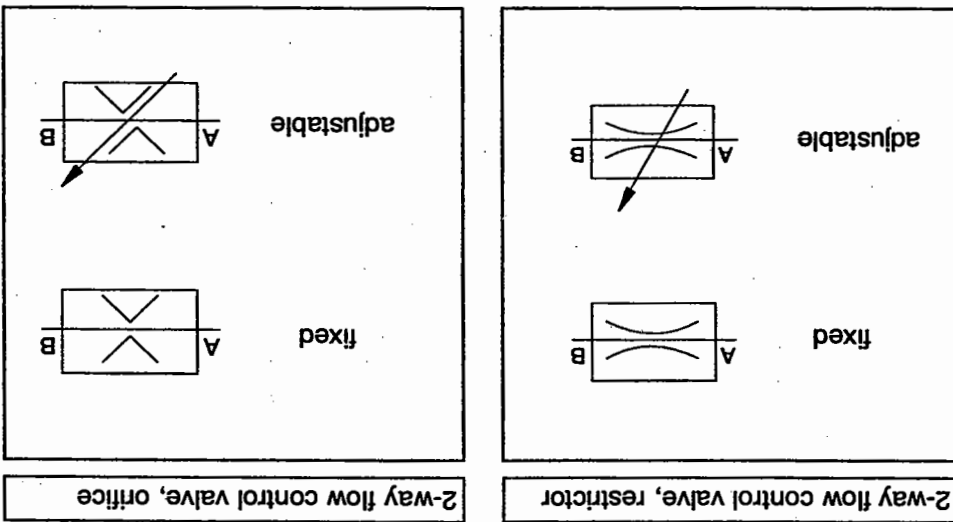

If it is possible to adjust the resistance – and thus the flow rate – of a flow control valve or flow regulator, this is indicated in the symbol by a diagonal arrow.

Adjustable flow valve

Non-return valves can interrupt the flow either in one direction or in both directions. The first type are called check valves, the second type shut-off valves.

Check valves are symbolised by a ball pressed against a conical sealing seat. This seat is represented by an open triangle in which the ball rests. It should be noted, however, that the tip of the triangle does not indicate the direction of flow but the blocked direction.

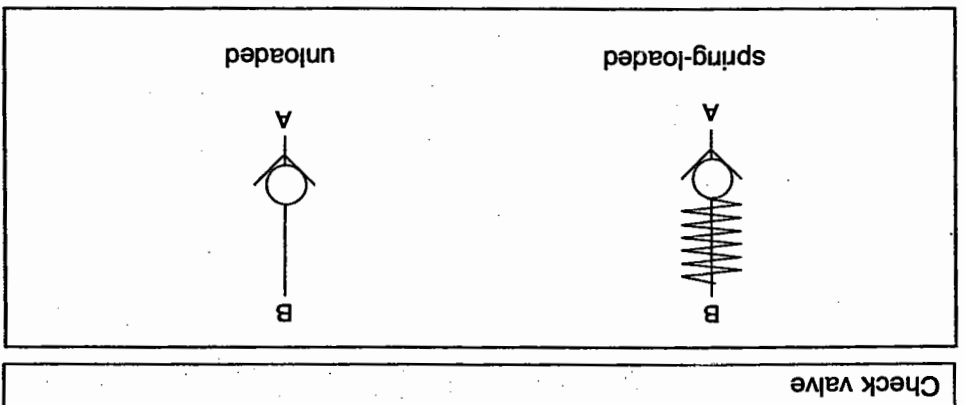

Piloted (de-lockable) non-return valves are represented by a square containing the symbol for the non-return valve. The pilot function of the valve is indicated by a pilot port drawn with a dotted line. The control port is identified by the letter X.

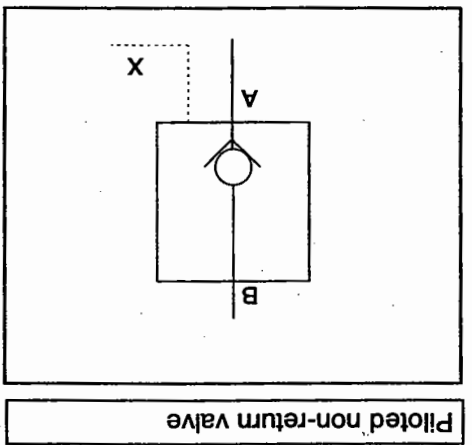

Shut-off valves are symbolised in circuit diagrams by two opposing triangles. With these valves, the orifice cross-section can be infinitely adjusted via a hand lever from completely closed to fully open. As a result, shut-off valves can also be used as adjustable flow control valves.

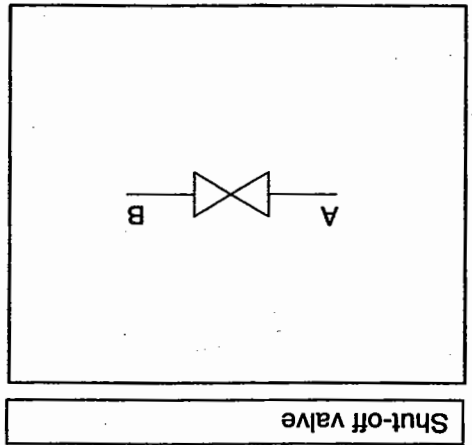

2.6 Cylinders

Single-acting cylinder

Cylinders are divided into single-acting cylinders and double-acting cylinders. Single-acting cylinders have only one port, and only one piston surface is pressurised with pressure fluid. They can only work in one direction. With these cylinders, cylinder return is either through external force – this is symbolised by the open bearing cover – or by a spring. The spring is then drawn in the symbol.

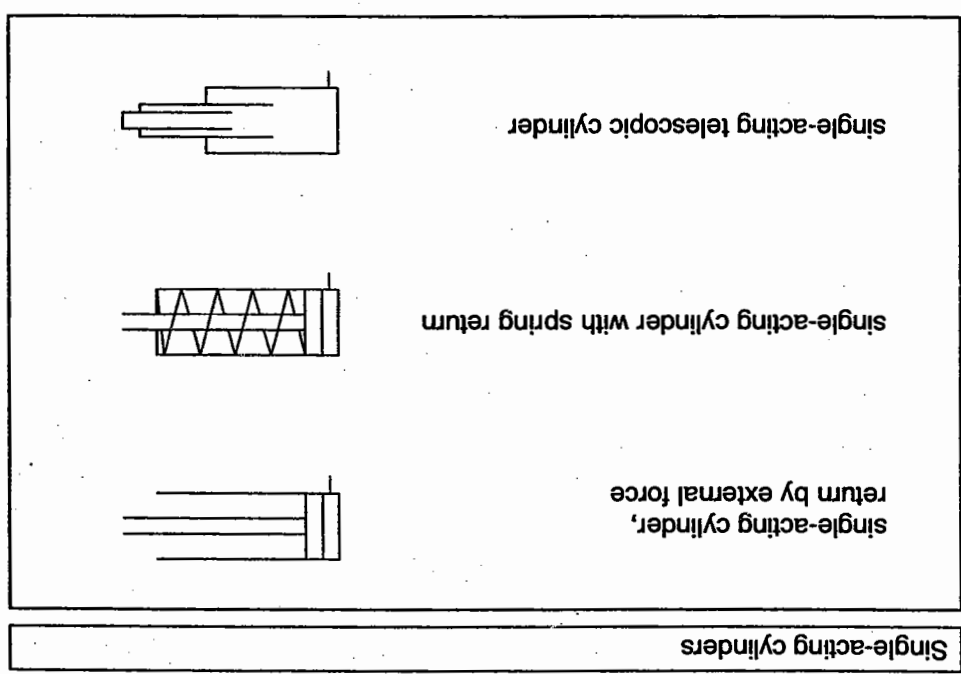

Double-acting cylinder

Double-acting cylinders have two ports for supply of pressure fluid to the two cylinder chambers.

- From the symbol for the double-acting cylinder with single-ended piston rod, it can be seen that the surface on the piston side is larger than that of the piston rod side.
- In the differential cylinder, the ratio of piston surface to piston rod surface is 2 : 1. In the symbol, the differential cylinder is represented by two lines drawn on the end of the piston rod.
- The symbol shows that in the cylinder with double-ended piston rod the two piston surfaces are of equal area (synchronous cylinder).

- Like the single-acting cylinders, double-acting telescopic cylinders are represented by pistons located inside another.
- For the double-acting cylinder with end position cushioning, the damping piston is shown by a rectangle.
- The diagonal arrow pointing upwards in the symbol indicates that the damping function is adjustable.

Double-acting cylinders

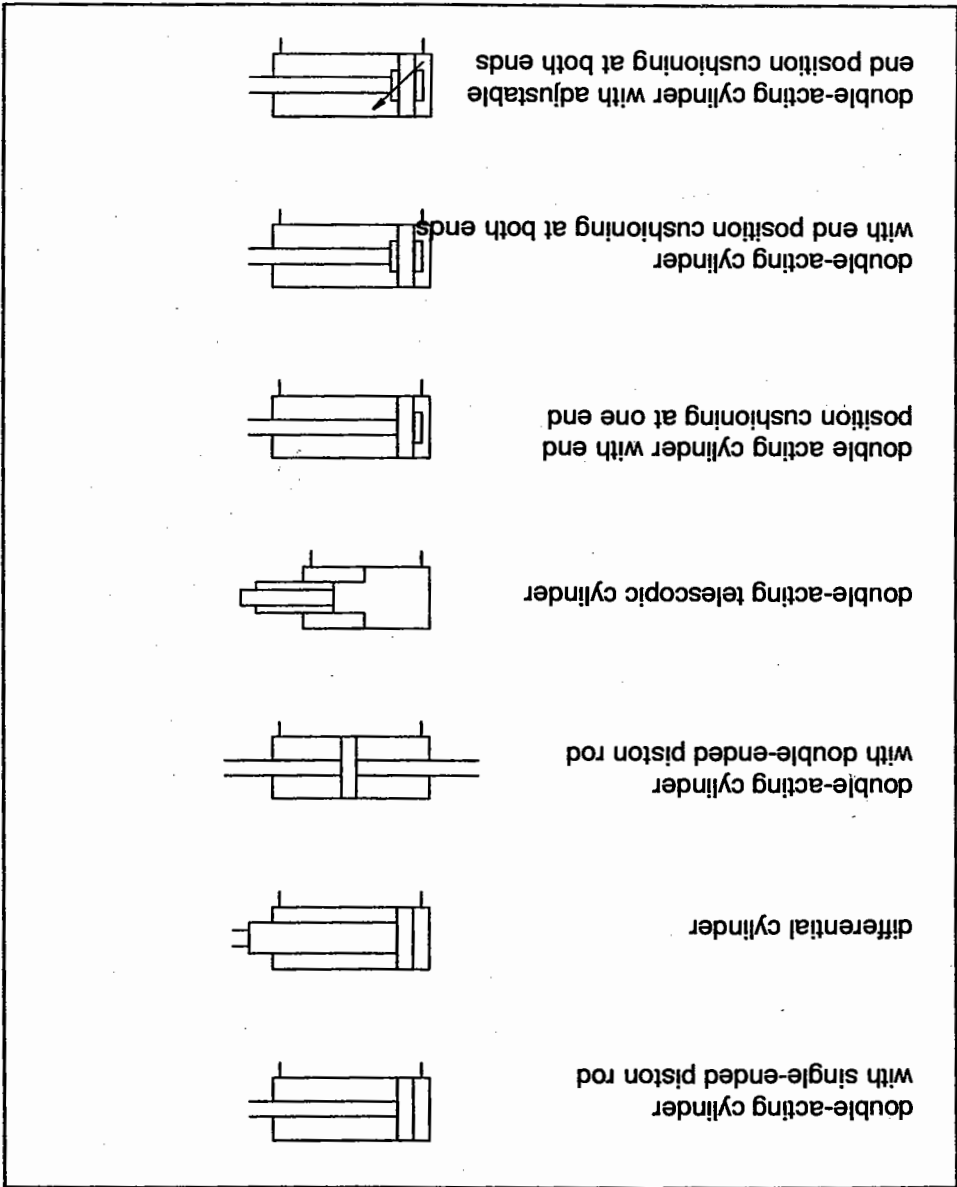

2.7 Energy transfer and preparation

The following symbols are used in circuit diagrams to represent the transfer of energy and the preparation of the pressure medium:

Energy transfer and pressure medium preparation

	pressure source, hydraulic
	electric motor
	heat engine
	pressure, power, return lines
	control line
	drain or leakage line
	flexible line
	line connection
	lines crossing
	vent
	quick coupling, connected to mech. opening, non-return valves
	reservoir
	filter
	cooler
	heater

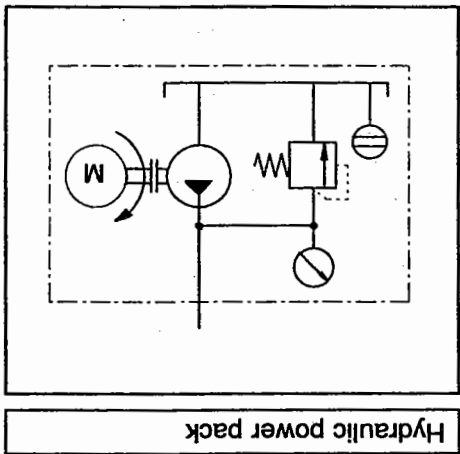
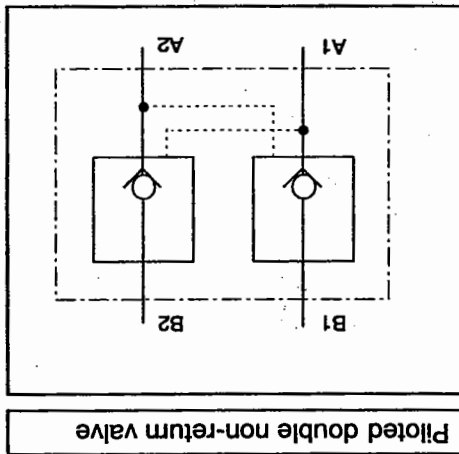

2.9 Equipment combinations

If several devices are grouped together in one housing, a dotted box is drawn around the symbols of the individual devices, and the connections are to be directed from this box.

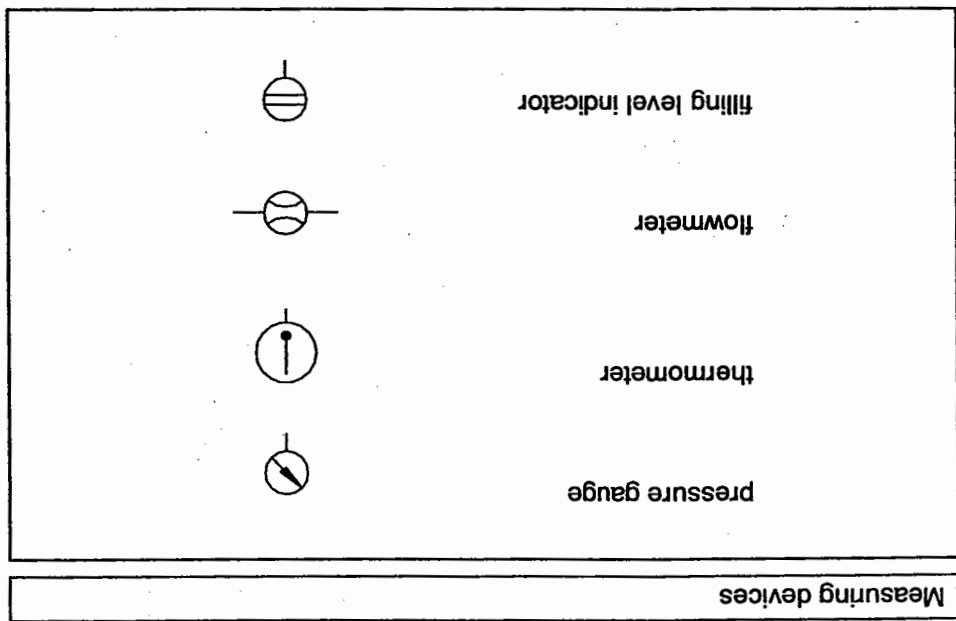

2.8 Measuring instruments

In the circuit diagrams measuring instruments are represented by the following symbols:

2.10 Electrical
circuit symbols

The following electrical symbols are used in the circuit diagrams of this book:

Electrical circuit symbols, general	
	direct voltage, direct current
	alternating voltage, alternating current
	rectifier (mains connection device)
	permanent magnet
	resistor, general
	coil (inductance)
	indicator light
	capacitor
	earthing, general

Switching elements

Switching elements are classified according to their basic functions as normally open, normally closed and changeover contacts. The following illustration shows the symbols required to denote these functions. You can find the complete list of graphic symbols for circuit documentation in DIN 40 900, Part 7.

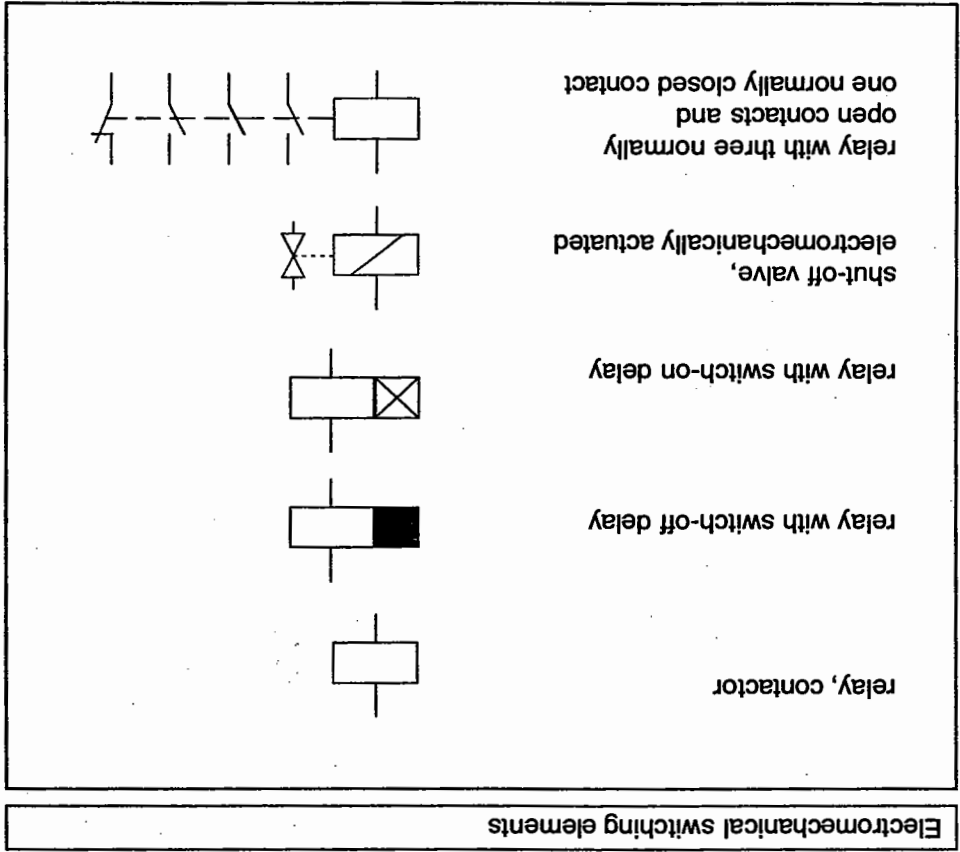

Electromechanical switching elements can, for example, be used to activate electric motors or hydraulic valves. The symbols for the most important types are shown in the following overview.

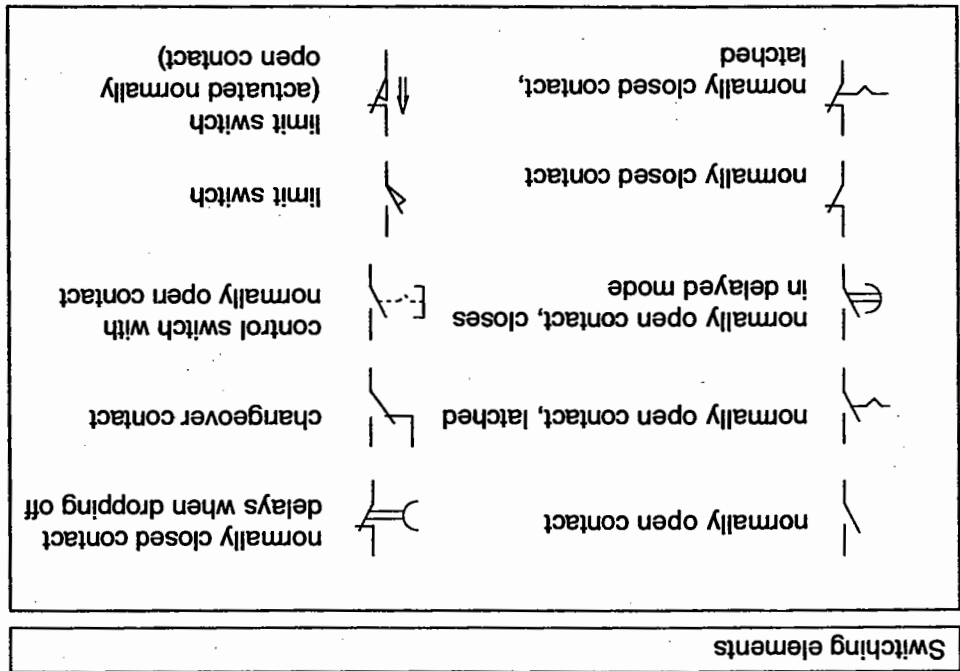

Proximity sensors react to the approach of an object by a change in electrical output signal. They are represented by a block symbol, in which the mode of operation of the proximity sensor can additionally be indicated.

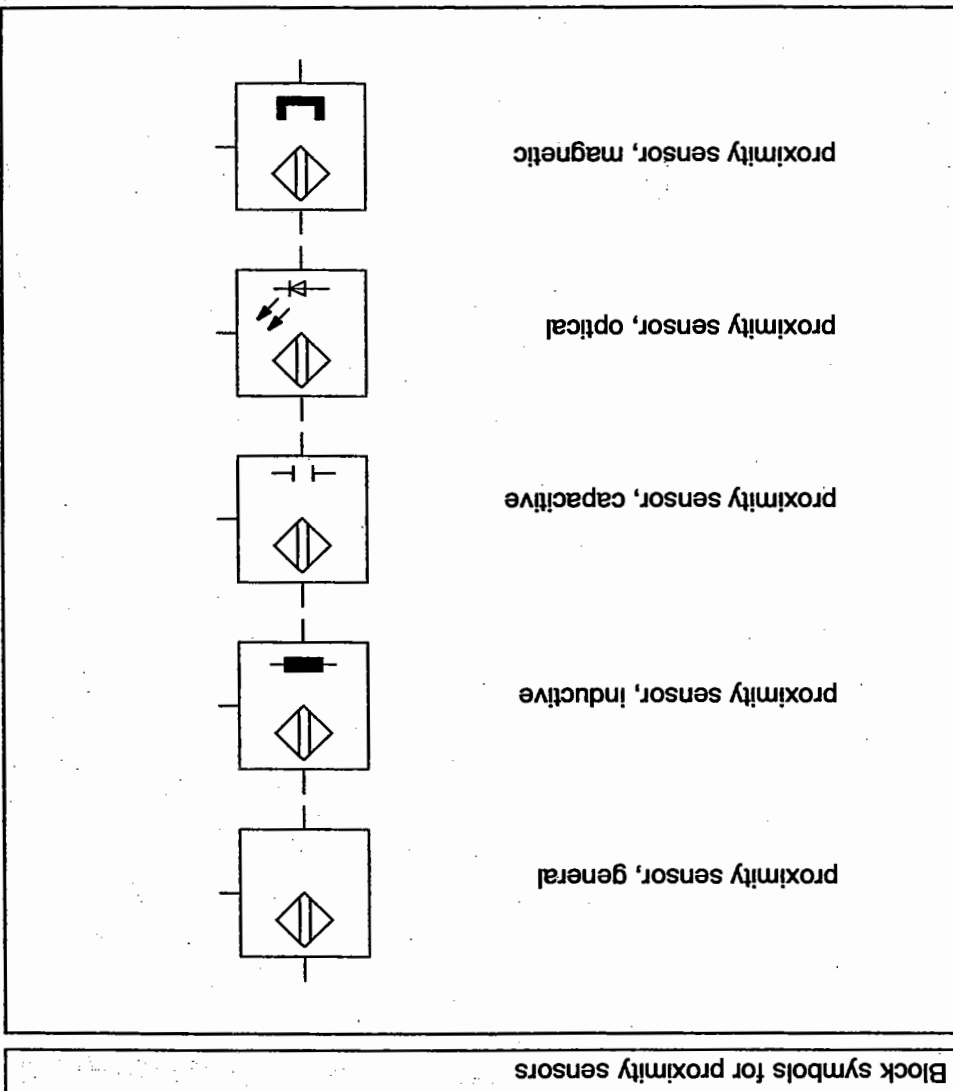

Electro-hydraulic control

Chapter 3



3.1 Hydraulic circuit diagram

The circuit diagram reproduces symbolically the design of a hydraulic system. With the help of circuit and graphic symbols, it shows how the various components are connected to one another.

To ensure that the circuit diagram is easy to follow, no account is taken of the spatial location of the components. Instead, the components are arranged in the direction of the energy flow. Their spatial arrangement is shown in a separate positional sketch. Directional control valves should be drawn horizontally where possible, whilst lines should be straight and uncrossed.

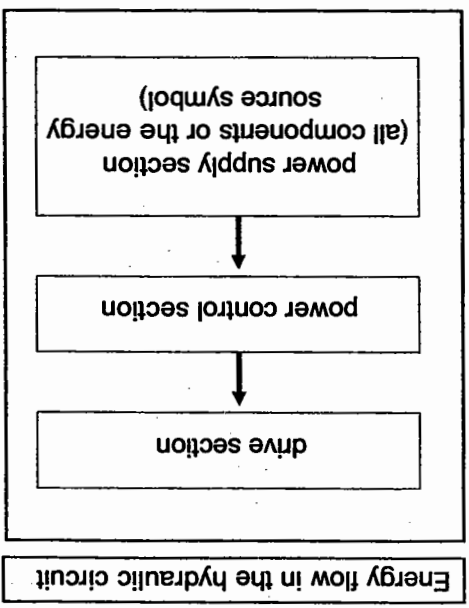

The hydraulic circuit diagram for an electro-hydraulic system is to be drawn in the following position:

- hydraulic power switched on.
- electrical power switched off.

This means:

- electrically activated valves are in their normal position; the valves are not actuated.
- cylinders and power components adopt the position which results when all electrically activated valves are in their normal position and the system is simultaneously supplied with pressure.

N.B.:

- Manually activated hydraulic systems are drawn in their initial position (pressures). The components are then in the condition required for commencement of the work cycle.
- The condition in which the hydraulic circuit diagram of an electro-hydraulic system is drawn does often not correspond to the initial position!



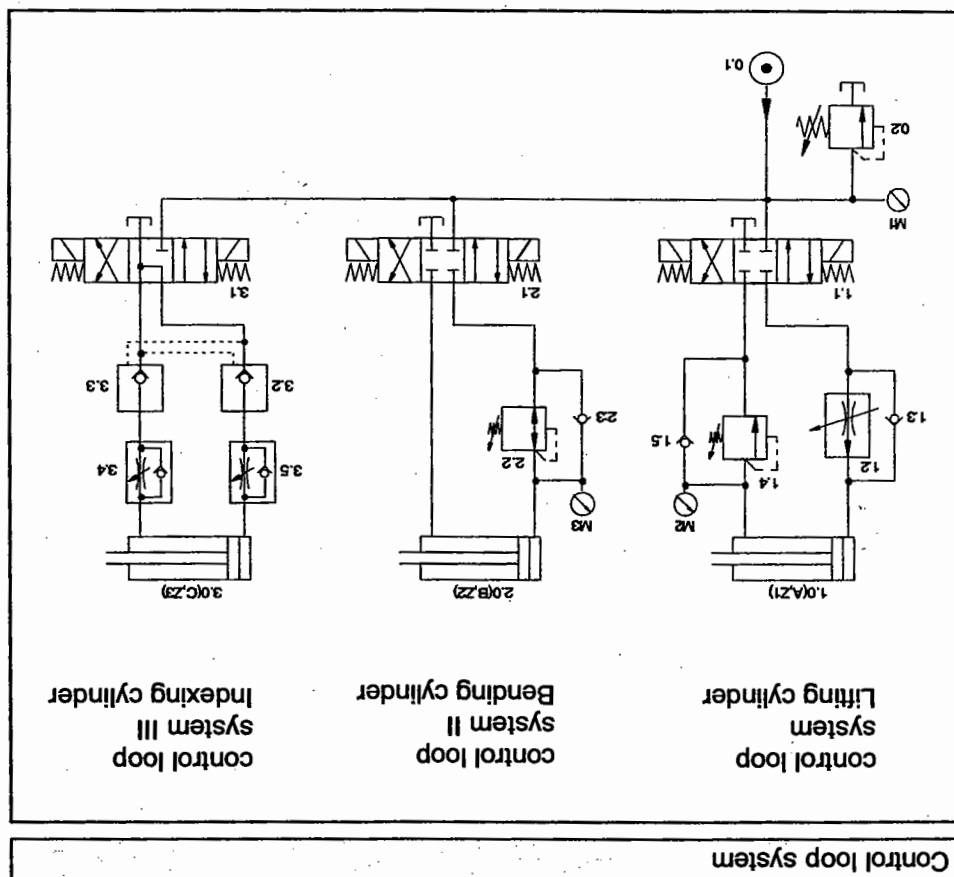

- If the control is a complex control with several drive components, these components should be divided up into individual control loop systems.
- One drive component and the corresponding power control section make up a control loop system.
 - Complex controls consist of several control loop systems. These control loop systems are to be drawn next to one another in the circuit diagram and identified by an ordinal number.
 - Wherever possible, these control loop systems should be drawn next to one another in the order in which they operate in the motion sequence.

Designation of components in the hydraulic circuit diagram using numbers

In this textbook, the components in hydraulic circuit diagrams are given numbers. The designation is made up of a group number and an equipment number. The various control loop systems are consecutively numbered using the ordinal numbers 1, 2, 3, etc. The power supply section is not assignable to any one control loop system as it is responsible for several control systems. For this reason, it is always designated by the ordinal number zero.

Group assignment	
Group 0	all power supply elements
Group 1, 2, 3 ...	designation of the individual control loop systems (normally one group number per cylinder)

Each component in a control loop system is to be identified by an equipment number made up of the ordinal number of the control loop system and a distinctive number.

Equipment numbering

0	drive component, e.g. 1.0, 2.0
.1	final control elements, e.g. 1.1, 2.1
.2, .4	even numbers: all elements influencing the forward flow, e.g. 1.2, 2.4
.3, .5	uneven numbers: all elements influencing the return flow, e.g. 1.3, 2.3
.01, .02	elements between final control element and drive component, e.g. throttle valve, e.g. 1.01, 1.02

In day-to-day operations, this designation system using group and equipment numbers has the advantage that maintenance personnel are able to recognise the effect of a signal by the number of the element in question. If, for example, a fault is ascertained in cylinder 2.0, it can be assumed that the cause is to be sought in the 2nd group and, therefore, in elements whose first number is 2.

3.2 Electrical

circuit diagram

Terminal designations for switching devices

In the electrical circuit diagram the connections of switching elements with single contacts are designated by single digit numbers.
The normally closed contacts are assigned the function digits 1 and 2, and the normally open contacts the function digits 3 and 4. The terminals of the changeover contacts are designated by the function digits 1, 2 and 4. Detailed explanations can be found in DIN EN 50 005 and DIN EN 50 011-13.

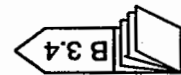
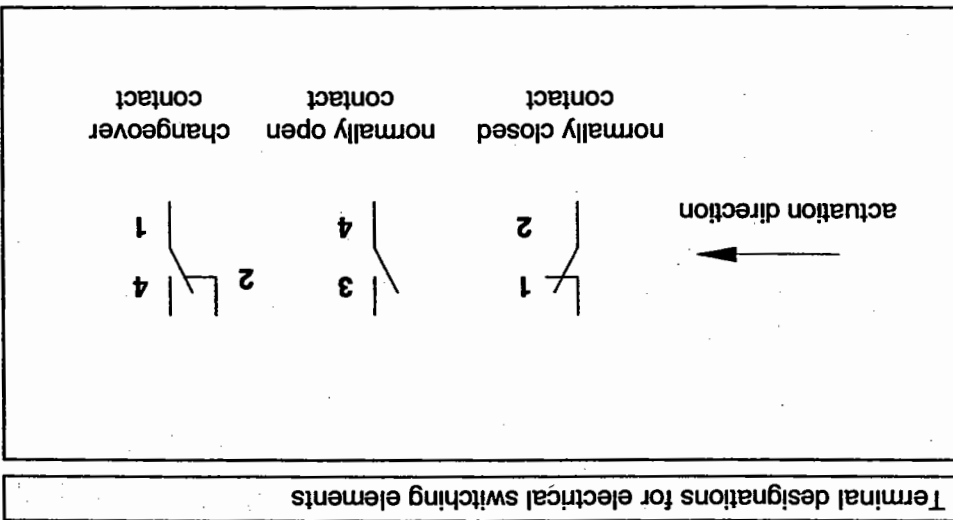

Terminal designations for relays

- the first digit is the ordinal number,
- the second digit is the function number.

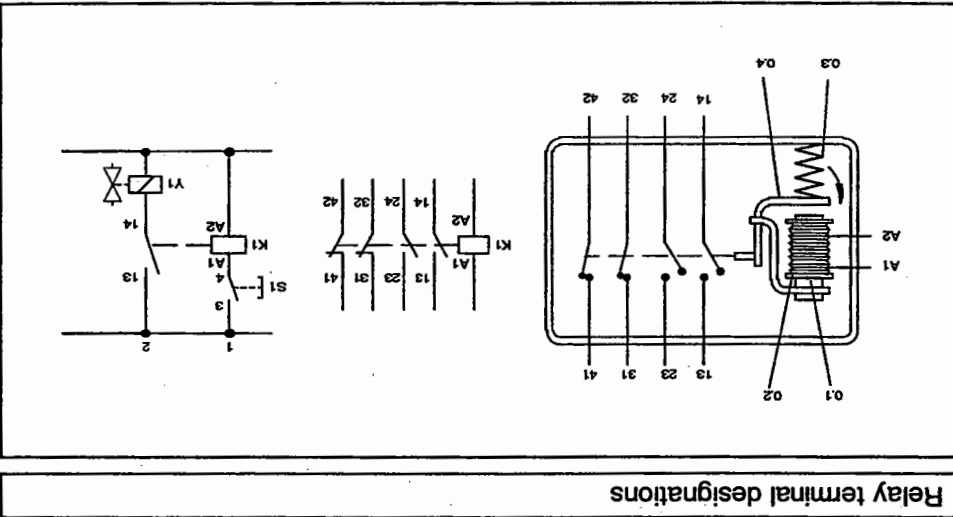

In the circuit diagrams, the relay coils are designated by K and a whole number, e.g. K1, K2 etc. The coil terminals are designated by A1 and A2.

The schematic diagram contains horizontal voltage lines and vertical current paths numbered from left to right. Switching elements are always shown in unpowered state and are to be drawn in current path direction, in other words vertically. If other modes of representation are unavoidable, it is essential that this is noted on the schematic diagram.

In order to ensure that the schematic diagram of large-scale systems does not become too unwieldy, the overall schematic diagram should be broken down into smaller schematic diagrams. Such a schematic diagram can be divided up, for example, according to drive elements (cylinder 1, cylinder 2, ...), system parts (feed carriage, drilling unit, ...) or functions (rapid traverse, feed, EMER-GENCY-STOP, ...).

The schematic diagram is a detailed illustration of a circuit in current paths with components, lines and connection points. This diagram does not take account of the spatial position and the mechanical interrelationships of the individual parts and equipment.

Schematic diagram

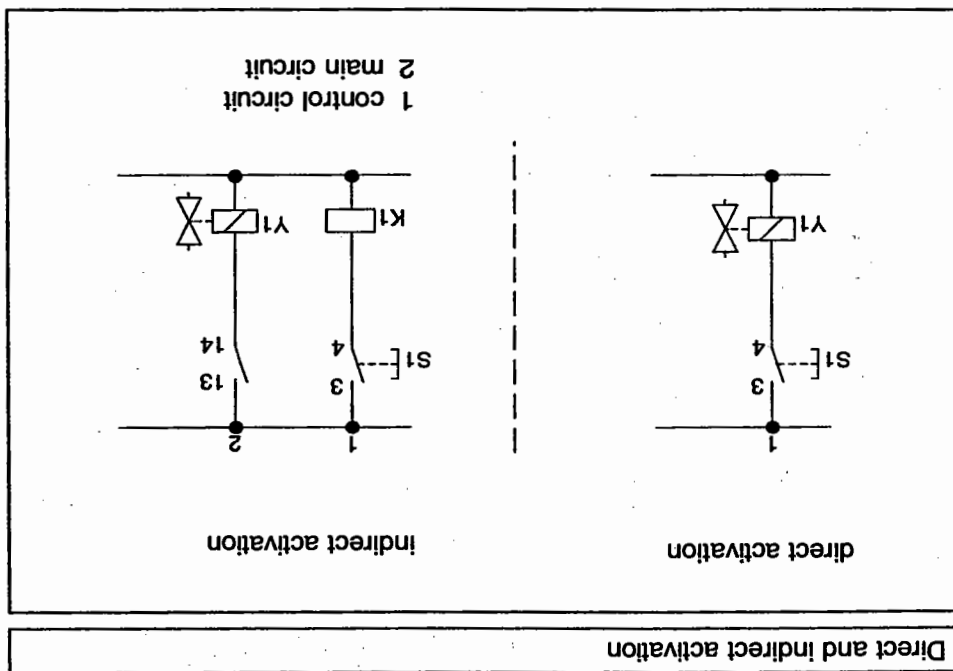

The solenoid coil of the valves forms the interface between the hydraulic power section and the electrical signal section. The electrical circuit diagram – the so-called schematic diagram – shows how these solenoid coils are activated. It is possible to supply the solenoid coils of the valves with voltage directly via a switch or indirectly via a relay. In the case of indirect activation, a distinction is made between the control circuit (protective circuit of the relays) and the main circuit (protective circuit of the valve solenoids).



Solenoid coil activation

Displacement-Time diagram

In the Displacement-Time diagram, the path traversed by a component is plotted against time. In contrast to the Displacement-Step diagram, the time is plotted in scale and creates the time-related connection between the individual drive components. This means that the varying durations of the individual steps can be read off directly from the diagram.

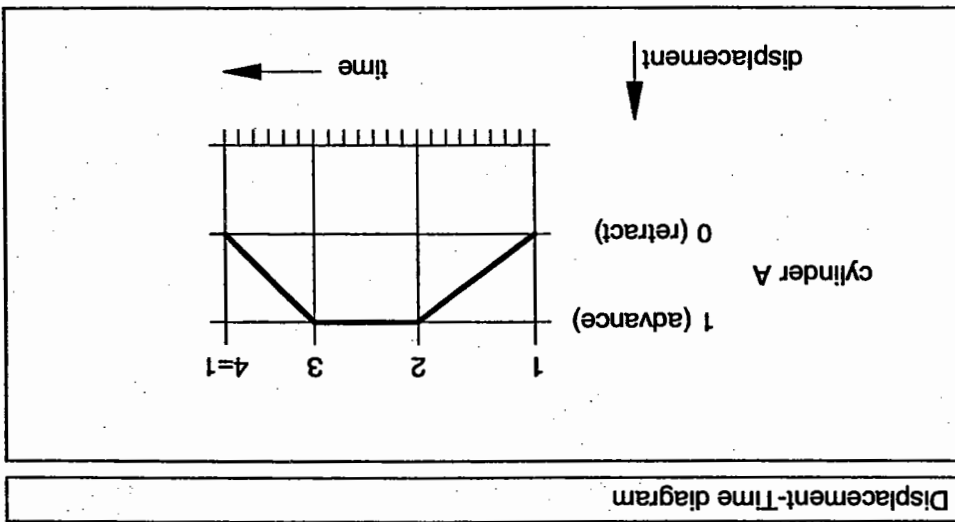

Control diagram

In the control diagram, the switching statuses of the signal input elements and signal processing elements are plotted against the steps. The switching times are considerably shorter than the traversing times of the drive components and are therefore not taken into account in the diagram; in other words, the signal edges are vertical. It is advisable to compile the control diagram in combination with the Displacement-Step diagram.

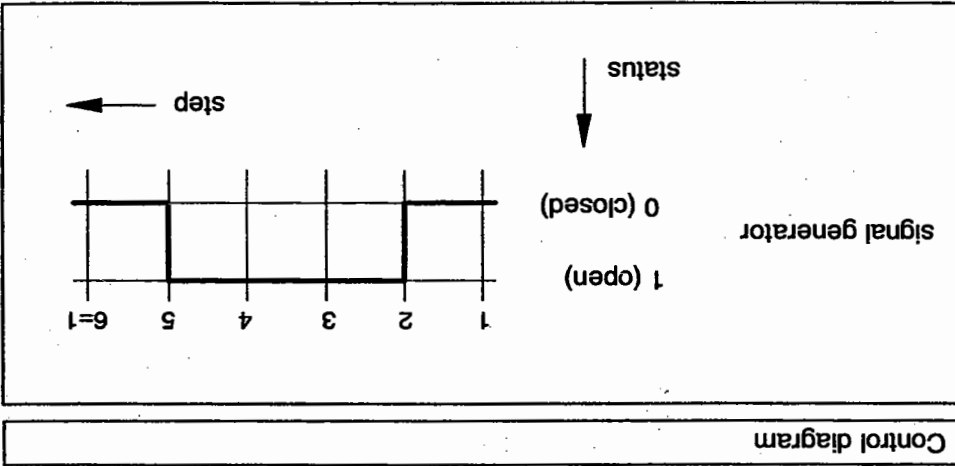

The most important signalling elements and forms of signal logic for electro-hydraulic systems are shown in the two following diagrams. A full list can be found in the VDI 3260 guideline.

- the points at which the signals from power controllers, push-buttons, limit switches, pressure switches etc. intervene in the operating sequence
- and how the signal input, signal processing and drive333 components influence one another.

In addition, the function diagram contains details of

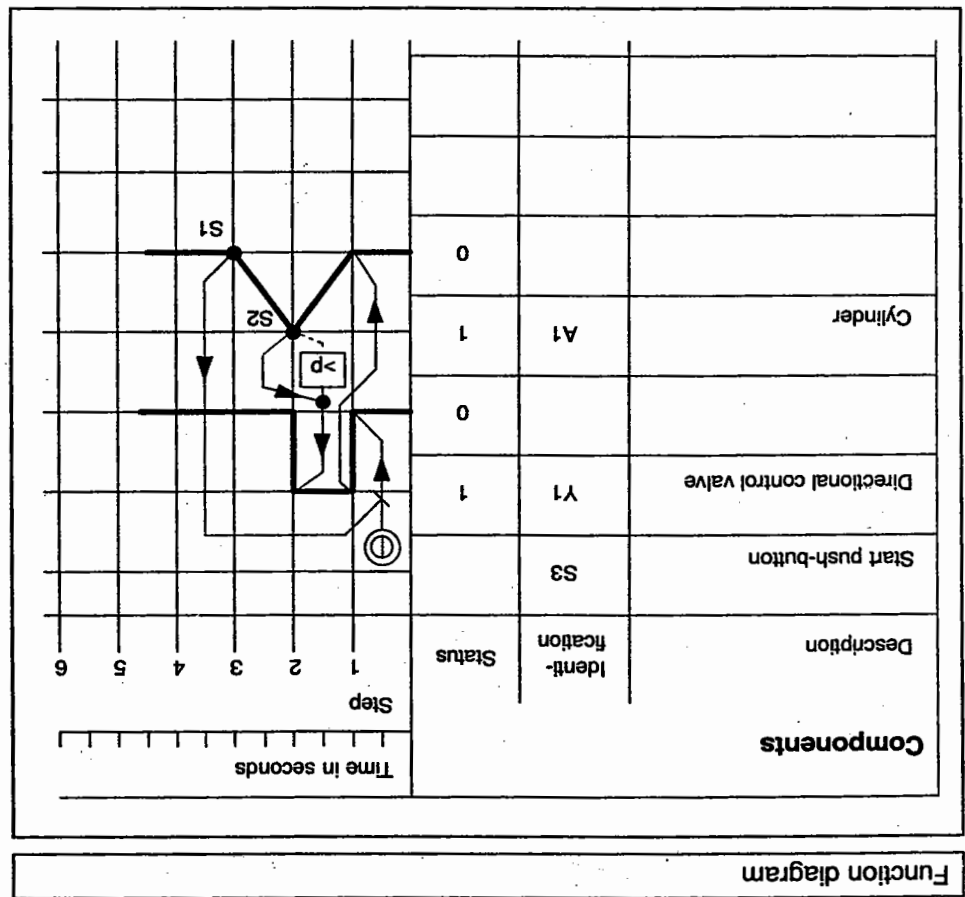

are drawn below one another. The function diagram therefore provides a good illustration of the operating sequence of an overall electro-hydraulic system.

- the control diagrams for all signal input and signal processing elements as well as
 - the Displacement-Time or Displacement-Step diagrams for all drive components
- In the function diagram to VDI 3260

Function diagram

- As soon as the start button is pressed and the piston rod of the cylinder is in the retracted end position (position 0) (limit switch S1 actuated), the directional control valve is switched over.
 - The piston rod of the cylinder advances.
 - As soon as the piston rod has reached the forward end position (limit switch S2 actuated) or the pressure switch is actuated, the directional control valve is switched back to its original position.
 - The piston rod of the cylinder retracts.
 - If the start button is pressed again, the operating cycle is repeated.
- Reading of function diagrams is explained using the function diagram on the previous page.

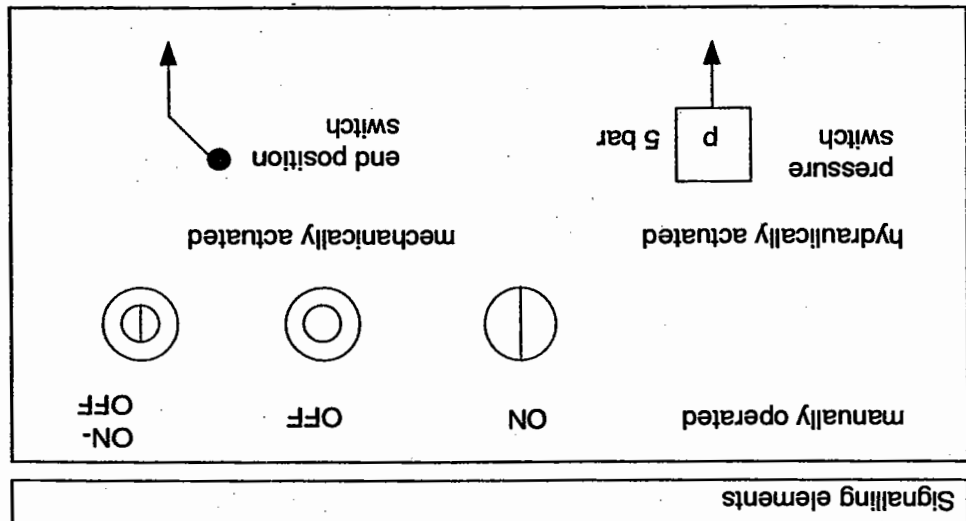
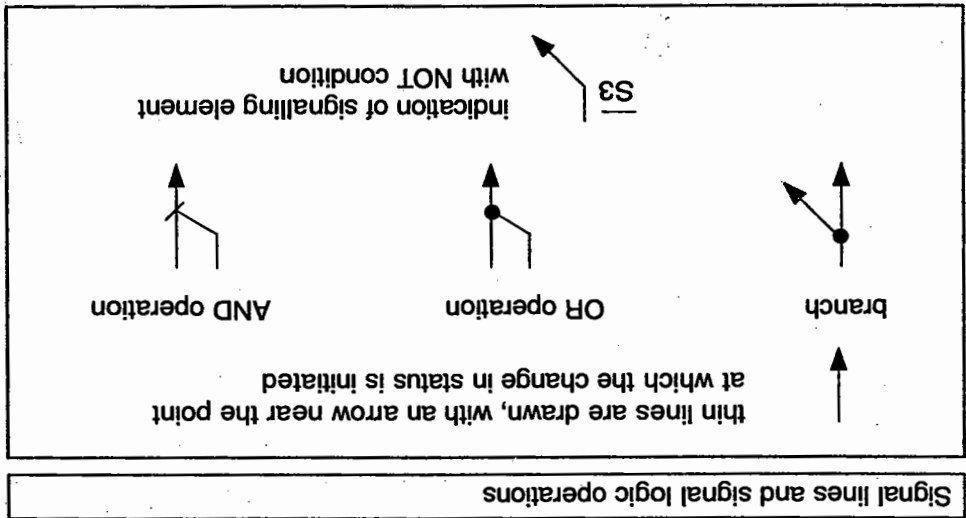

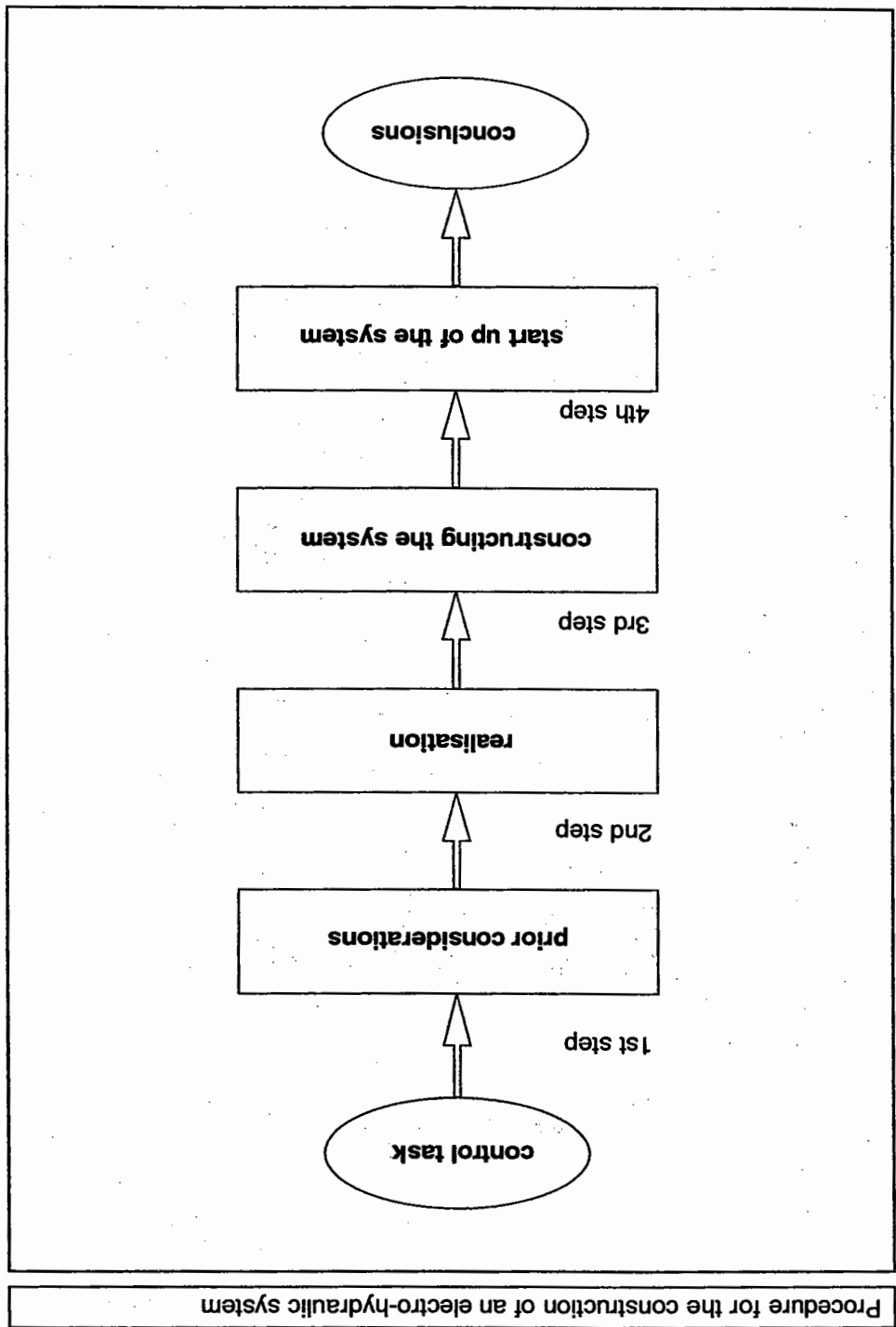

What steps lie between the formulation of a theoretical control task and the construction of an operational electro-hydraulic system?
 Experience shows that this task is best solved by following a procedure consisting of 4 steps.

3.4 Procedure for the construction of an electro-hydraulic system

Step 1: Prior considerations

First, it must be ascertained which functions the control is to perform. An exact knowledge of the desired functions is necessary to ensure that the control can be properly constructed and function-tested.

The type of motions required of the drive components are to be laid down in the 1st step:

- which type of motion is necessary – linear or rotating ?
- how many different movements need to be effected – how many power components need to be used?
- how do the movements interact?

Once it is clear which motions need to be generated, the parameters of the system should be laid down. To calculate these parameters, we start at the consumer (power component) and work back towards the power supply unit to ascertain the required forces/moments, speeds, flow rates and pressures.

It is then possible to select the appropriate hydraulic and electrical components for the control.

In the 2nd step, the diagrams, circuit diagrams and parts lists are compiled.

First, the graphic diagrams are drawn to provide a clear overview of the motion sequences.

- The Displacement-Step diagram shows the sequence of the power components according to the respective steps.
- The displacement of the power components over time is plotted on the Displacement-Time diagram.
- The function diagram to VDI guideline 3260 shows the function sequences of controls.

Step 2: Realisation
Drawing
of graphic diagrams

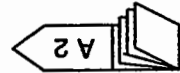

Compilation
of the circuit diagrams

The next job is to draw the electrical and hydraulic circuit diagrams. When compiling these circuit diagrams, the symbols for the electrical and hydraulic components described in Chapter A2 should be used and the notes on the drawing of circuit diagrams contained in this chapter observed.

When the electrical and hydraulic circuit diagrams have been completed, they must be checked. It should be ensured that the control portrayed in the circuit diagrams fulfills the functions required in the task description.

Before the control can be constructed, measuring equipment (depending on the exercise), and technical data and numbering related to equipment, must be added to the circuit diagrams. Then the equipment settings need to be entered in the circuit diagrams.

Then the parts list is to be drawn up. This list contains all the equipment required for construction along with the following details:

- item number
- quantity
- description

When constructing the system, you should adhere to a systematic procedure to minimise faults and errors:

- observe safety recommendations (see Chapter B4),

- make sure that circuit diagrams are to hand,

- prepare the equipment as listed in the parts list,

- adhere to the stipulated sequence during construction:

in the signal control section from signal input via signal processing and control power supply to the power control section;

in the hydraulic power section from the power supply section via the power control section to the drive section,

- identify the equipment already installed on the system in the circuit diagram step by step,

- designate all equipment as well as pipelines, conduits and cables,

- observe the basic rules for the installation and connection of components.



Step 3: Constructing the system

Compilation

of the parts list

Step 4: Start-up of the system

When construction of the system is complete, the practical function test can be performed. If the test is to comprise the function of the system as well as the recording of the operating conditions, the necessary documentation (value tables, diagrams) is to be prepared.

The system should not be started until the layout and the component connections have been re-checked.

The best way to start up a system is as follows:

- check the oil level; top up with the correct type of oil if necessary (maximum level), using a filter to filter out any impurities,
- vent the pump by filling it with oil,
- check the direction of rotation of the electric drive motor,
- set all valves to their initial positions,
- set pressure valves and flow valves to the lowest possible setting – the same applies to the pressure regulators of actuating pumps,
- if necessary start the system using a flushing oil, then change the filter,
- top up with fresh oil, vent the system once again,
- check the fluid level,
- check the electrical cables,
- check the terminal assignment of the individual components,
- perform the first function test at reduced pressure and flow rate,
- set the operating values laid down in the circuit diagrams (pressure, flow rate, voltage).

The function test and the measurements can now begin. During the tests, the required data are to be recorded and entered in tables. After the test is completed, the results are to be evaluated and remarks formulated. It is advisable to draw up a test certificate.

Function test

Actuation of a single-acting cylinder

Chapter 4



Preliminary remarks

Basic knowledge of hydraulic power packs is required to solve the following exercises. A hydraulic power pack consists of drive motor, hydraulic pump with suction filter, safety pressure relief valve, oil tank and a pressure relief valve which can be adjusted to the required system pressure.

Hydraulic power pack: detailed and simplified representation

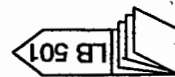
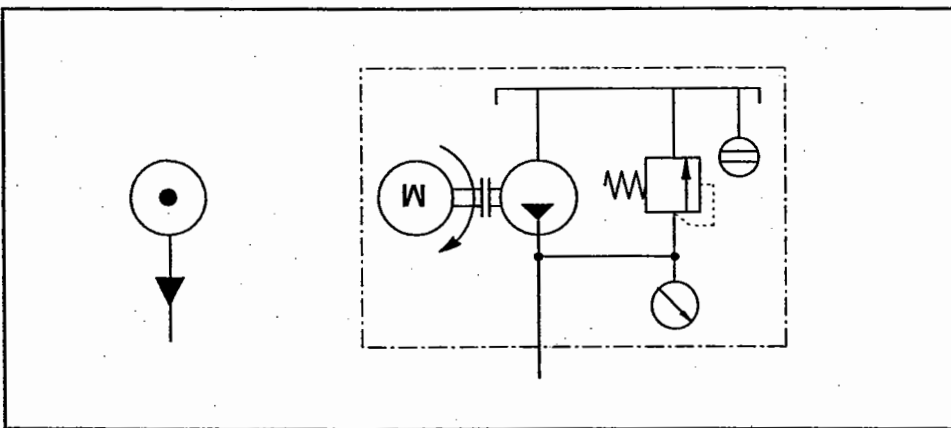

A detailed description of the hydraulic power pack can be found in the "Hydraulics" textbook (LB501) published by Festo Didactic KG.

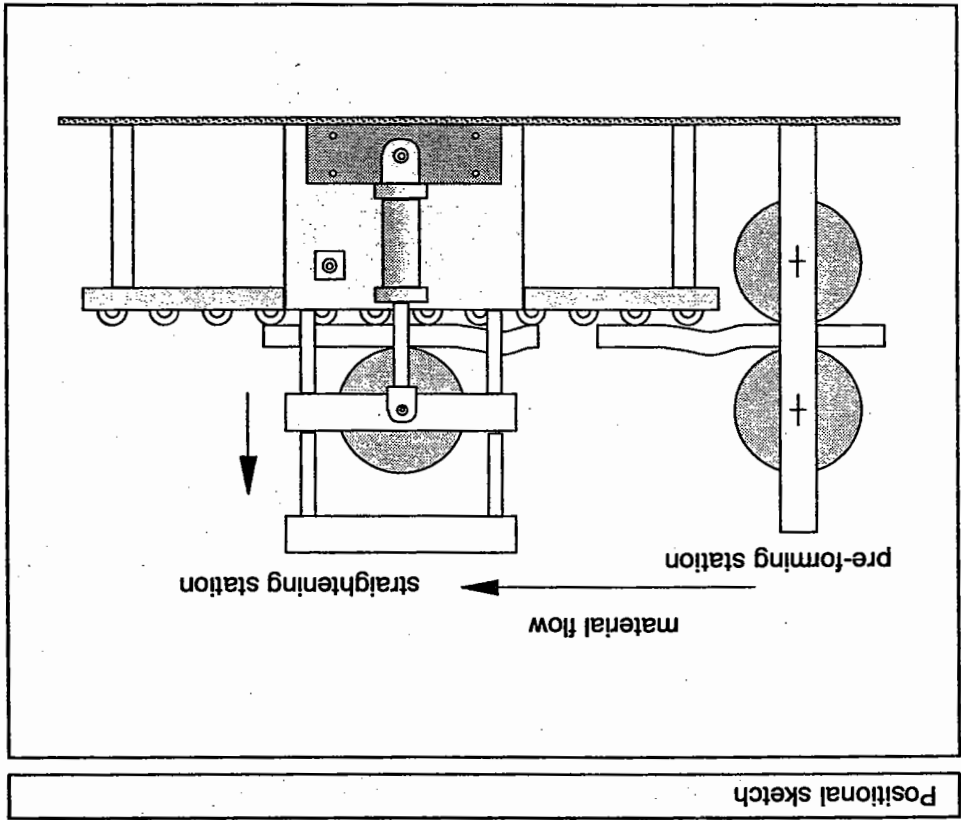

In the cold rolling of steel plates, a station for straightening of the cold-worked parts is required behind the pre-forming unit. There, each sheet is straightened by the intrinsic weight of a pressure roller. To ensure that the incoming sheet does not collide with the pressure roller, the roller must be lifted by a single-acting cylinder. This cylinder should advance at the press of a button and retract through the weight of the roller when the button is released.

Direct solenoid valve actuation

4.1 Exercise 1

Problem definition



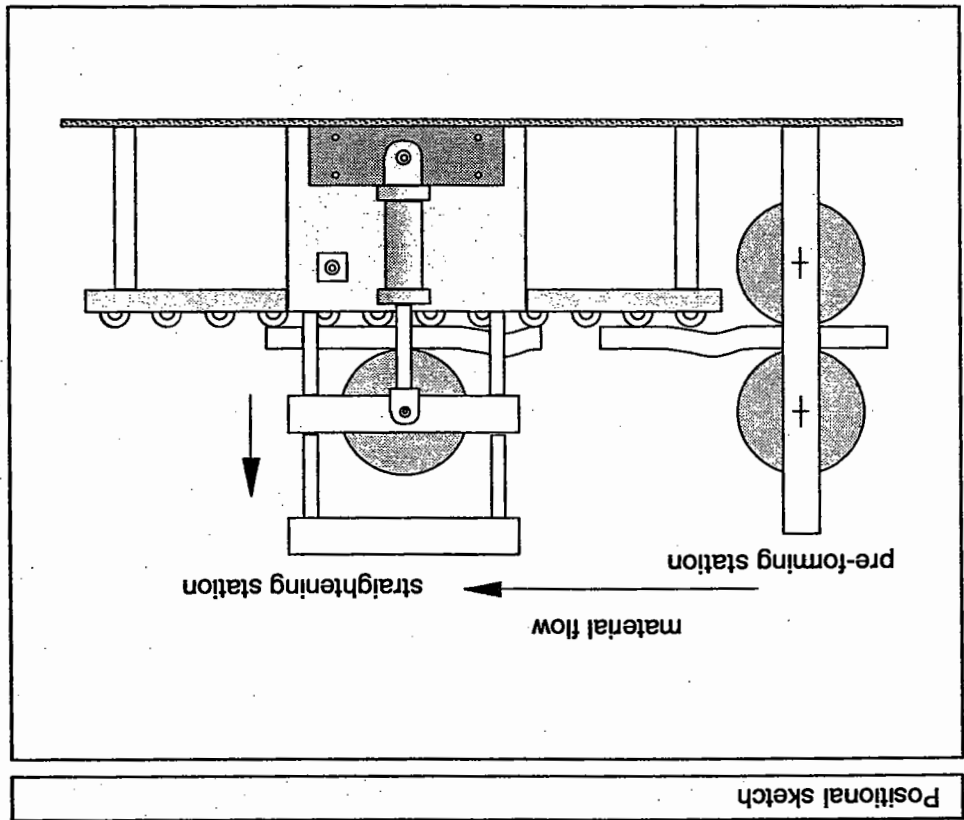

In the cold rolling of steel plates, a station for straightening of the cold-worked parts is required behind the pre-forming unit. There, each sheet is straightened by the intrinsic weight of a pressure roller. To ensure that the incoming sheet does not collide with the pressure roller, the roller must be lifted by a single-acting cylinder. This cylinder should advance at the press of a button and retract through the weight of the roller when the button is released.

Direct solenoid valve actuation

4.1 Exercise 1

Problem definition

Conclusions

Hydraulic control

A single-acting cylinder and a magnetically actuated 3/2-way valve (3/2-way electromagnetic valve) are used in this exercise.

In single-acting cylinders only the piston side is supplied with pressure fluid. This is why these cylinders can only work in one direction. The fluid flowing into the piston chamber builds up a pressure at the piston surface against external and internal resistances. The resulting force moves the piston into the forward end position. The return stroke is effected by the external load of the roller. The pressure fluid flows back from the cylinder into the tank.

Single-acting cylinder

Directional control valve

A 3/2-way valve has three ports:

- pressure port (P)
- tank port (T)
- power port (A)

and two switching positions:

- normal position: return flow from the piston chamber of the cylinder to the power port (A) and then to the tank; the pressure port (P) is blocked.
- actuated position: flow from the pressure port (P) to the power port (A) and then to the piston chamber of the cylinder; the tank port (T) is blocked.

Solenoids



Electrical control

The directional control valve is actuated via a solenoid. When the preset voltage is applied to the coil, a magnetic field is created. The resulting force at the armature pushes the piston of the directional control valve against the return spring, thereby actuating the valve. When the voltage is switched off, the magnetic field collapses and no forces are active. The return spring moves the piston back into the normal position.

The most commonly used hydraulic valves have solenoids designed for 24 V D.C.

Push-buttons are designed to actuate contacts. The contacts can close or open the current path or change between two current paths. When the push-button is released, the contact is returned to its original position by the force of the spring. Only when it is held down does the push-button revert to the desired switching position.

In contrast to push-buttons, control switches possess a detent mechanism. The switched position remains the same until the switch is pressed once again (signal storage).

In the non-actuated state, a current circuit with normally open contacts is open. When the contact is actuated, the current circuit is closed.

When the normally closed contact is in the normal position, the current circuit is closed. When it is actuated, the current circuit is interrupted.

In changeover contacts, the functions "closing" and "opening" are accommodated in one housing. When the push-button is pressed, the contact of the normally closed contact is released and the current circuit is interrupted. At the same time, the current circuit is closed at the normally open contact.

The components of the signal control section normally operate via a 24 V D.C. supply. The alternating voltage of the mains supply therefore has to be transformed into direct voltage using a power supply unit.

The symbol for a power supply unit is only shown in the circuit diagram in this exercise. The subsequent exercises show only the 24 volt and 0 volt supply bars.

Each machine (control) must be fitted with a master switch via which all the electrical equipment can be shut down, for example for the duration of cleaning, maintenance and repair work and for lengthy downtimes. This switch must be hand-operated and may only possess an "On" and an "Off" position designated by 0 and 1. The Off position must be lockable to prevent manual and remote switch-on (VDE 0113). The SO master switch is generally fitted to all circuits described in this book. Operation of this switch is taken for granted and is therefore not described beyond this point.



Master switch

Power supply unit

Control switch

Contacts

Push-button

Carrying out the exercise
1st step

After you have studied the section on "Conclusions" and Chapter 3 "Construction of an electro-hydraulic system", please complete the electrical and hydraulic circuit diagrams and identify the elements using numbers.

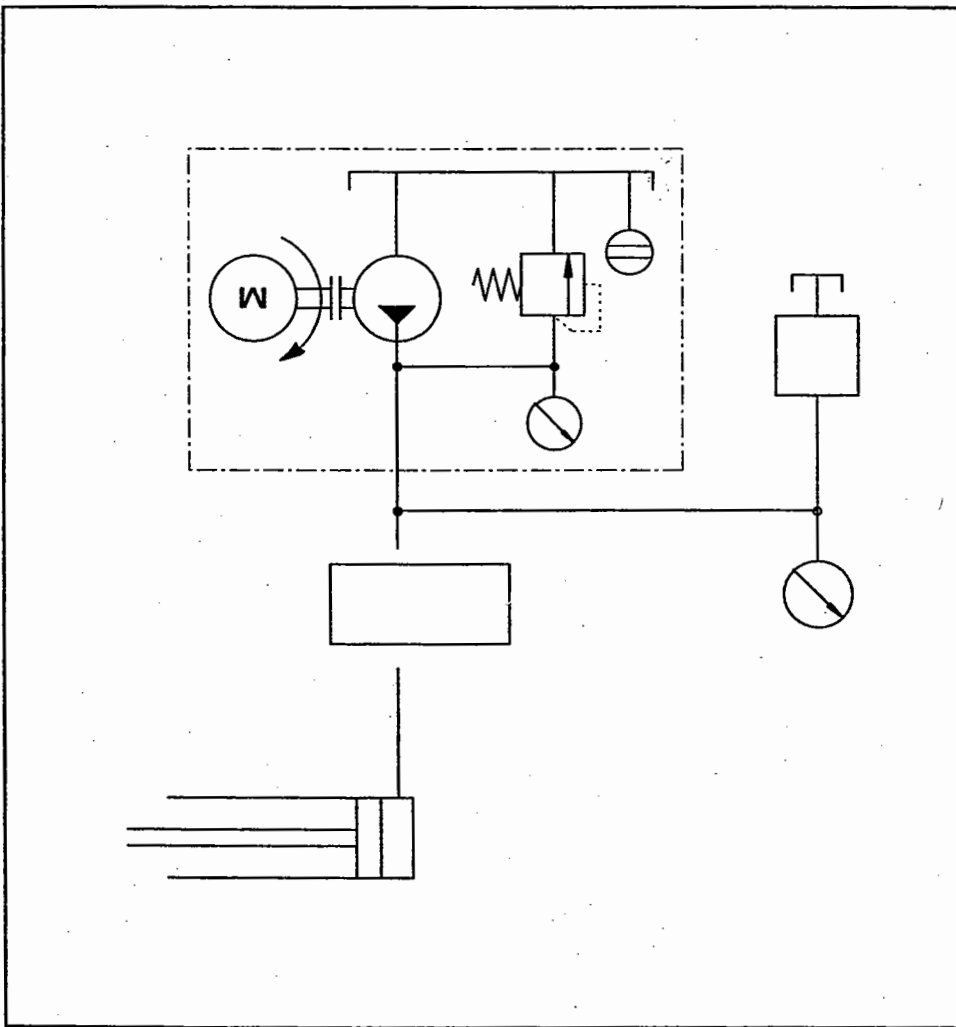

Hydraulic circuit diagram

Push-button selection		
1	2	3
250 V A.C. 4 A	220 V/110 V A.C. 1.5/2.5 A	24 V/12 V D.C. 2.25/4.5 A
12 V D.C. 0.2 A	5 A/48 V A.C.	4 A/30 V D.C.
1	1	2
NC contact:	NC contact:	NO contact:

If the power consumption of the solenoid valve is 31 W, a suitable push-button is to be selected. The following table shows three push-buttons with varying contact ratings and different contacts. Select the push-button which is appropriate for switching the current supplied to the solenoid valve.



For direct actuation of the solenoid valve, the push-button rating should be such as to ensure that the push-button is not damaged by heating-up or contact erosion, even when used in continuous operation.

2nd step

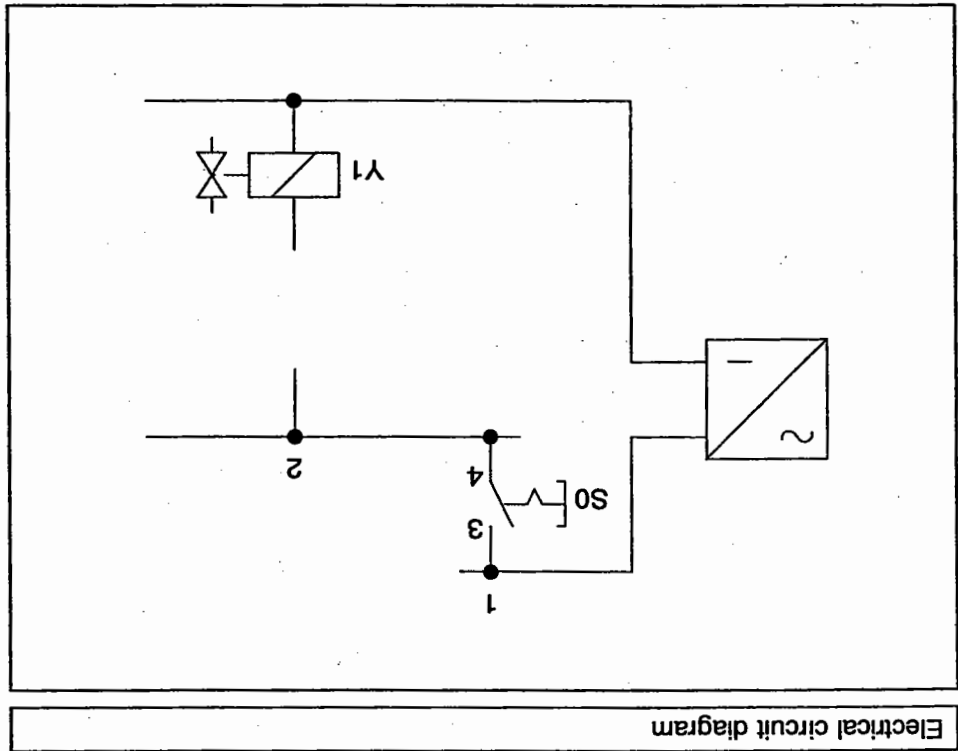

4.2 Exercise 2

Problem definition

Direct activation of the solenoid valve as effected in Exercise 1 is only suitable for practice-based operations under certain conditions. The relatively high current flowing in the coil of the solenoid valve also flows through pushbuttons and cables. This means that contacts and cables have to be designed to cope with this load.

In practice, it is preferable for signal input to be effected using a minimum of power, as this allows the use of smaller contacts and thinner cables. To generate the high level of current required for valve actuation, the signal then has to be amplified. For this purpose, the electrical circuit in Exercise 1 has to be modified so that the start push-button activates a relay, causing the contacts of the relay to energise the valve solenoid.

In the circuit in Exercise 1, the roller falls too heavily on the sheet when the pushbutton is released. Therefore, you should add a further valve to the hydraulic circuit diagram to reduce the flow rate during the return stroke. The advance stroke of the piston rod should, however, still be effected at full speed.

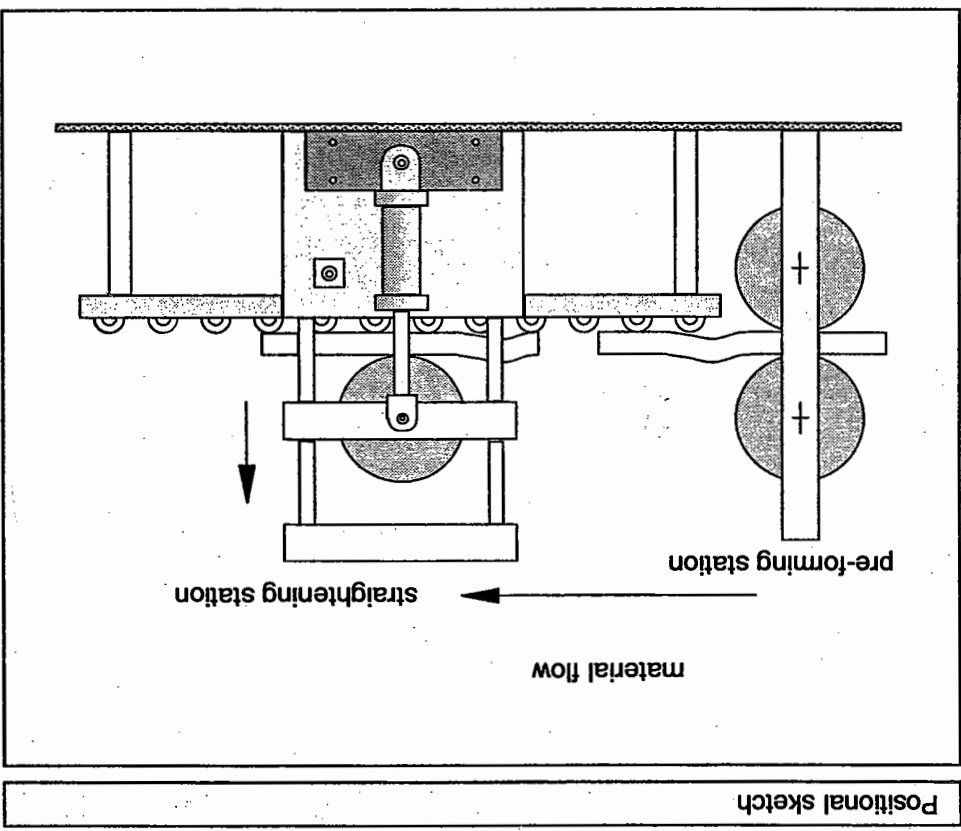

Hydraulic control

Conclusions

One-way flow control valve

Hydraulic elements which influence the flow rate are called flow control valves. For this application a valve of simple design – a throttle valve – is sufficient. In this exercise, only the return stroke should be throttled; the advance stroke should remain unthrottled. The throttle point therefore has to be bypassed during the advance stroke using a check valve. Throttle and check valve are available as a single unit. This unit is called a one-way flow control valve.

Electrical control

Electromagnetic switches

Electromagnetic switches consist of an electromagnet with a movable armature which actuates a specific number of contacts (contact assembly), the number of contacts actuated depending on the size of the armature. When current flows through the coil a magnetic field is created which switches the armature. If the flow of current is interrupted, the armature switches back to its original position through the force of a spring. The contacts of the contact assembly can take the form of normally open contacts, normally closed contacts or changeover contacts.

There are two types of electromagnetic switch:

- relays possess a clapper-type armature and are characterised by single contact separation.
- contactors possess a lifting armature and are characterised by double contact separation. Extremely large outputs are generally switched using contactors.

The contacts are identified by a function digit at input and output (DIN EN 50 005 and DIN EN 50 011-13). If there are several contacts, this digit is preceded by an ordinal number (see Chapter 3.2).



Carrying out the exercise
1st step

Select a suitable flow control valve and draw the hydraulic circuit diagram as in the previous exercise. Stipulate the point at which the flow valve can be installed.

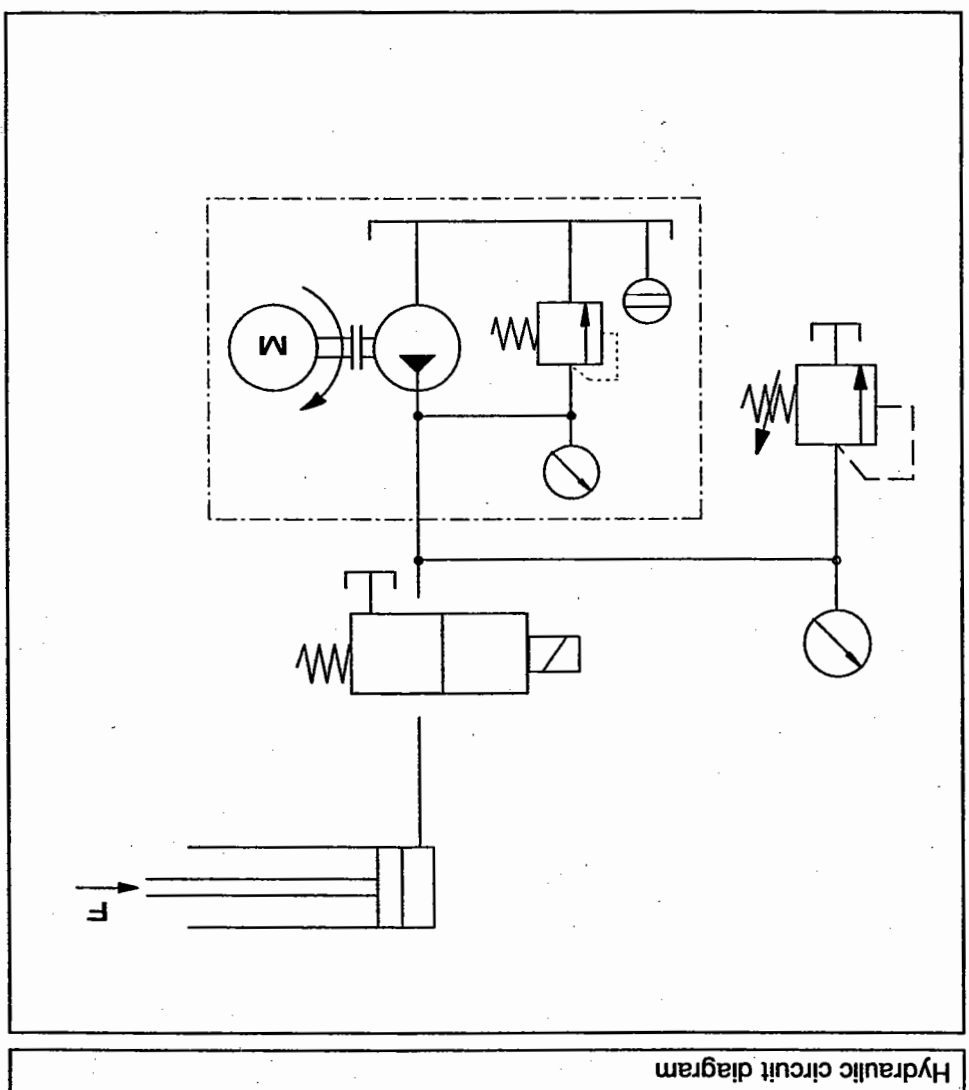

Draw the electrical circuit diagram and identify the control circuit and the main circuit. Make sure that the solenoid valve is actuated indirectly as specified in the task definition.

Electrical circuit diagram with indirect activation

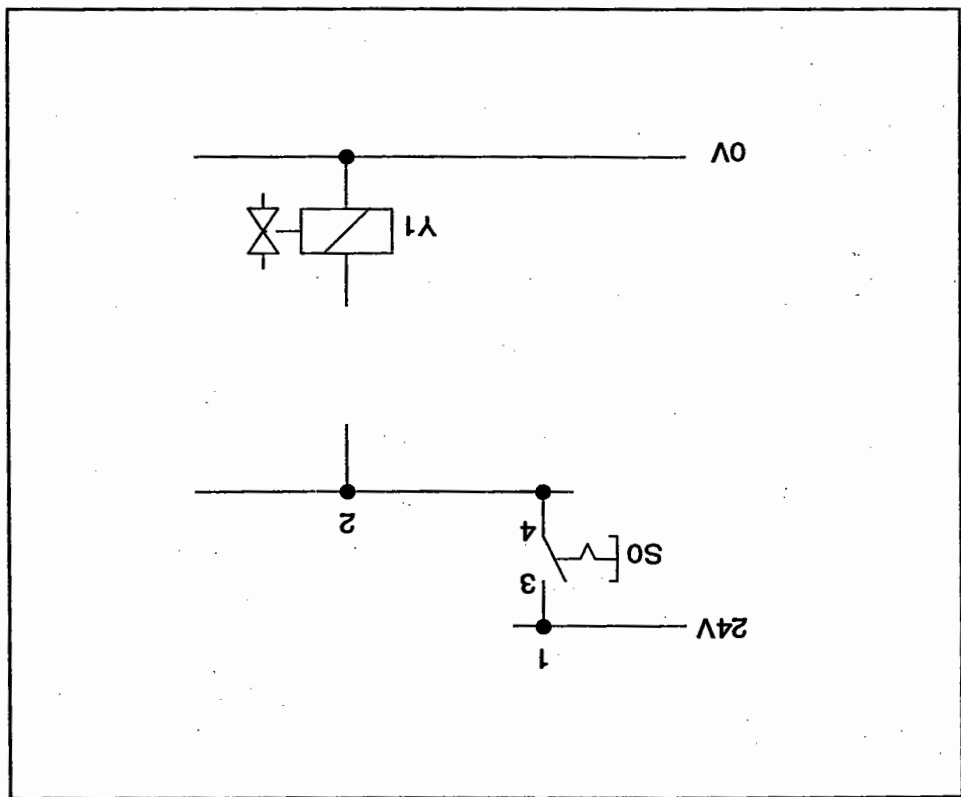

4.3 Exercise 3

Problem definition

Boolean basic logic functions

Tanks are to be produced in a forming press:

- In the starting position of the press (I) the press ram is retracted – in other words in the "up" position. The cushioned die is moved by a single-acting cylinder and is advanced in its initial starting position.
- If the blank is inserted, the working sequence begins. The ram is lowered and punches out the tank shape (II). The cushioned die is pressed downwards, as the force of the press ram is greater than the force of the cushioning cylinder acting on the die.
- When the ram moves back up, the single-acting cushioning cylinder also drives the die upwards. The finished tank can now be removed from the press (III).

Positional sketch

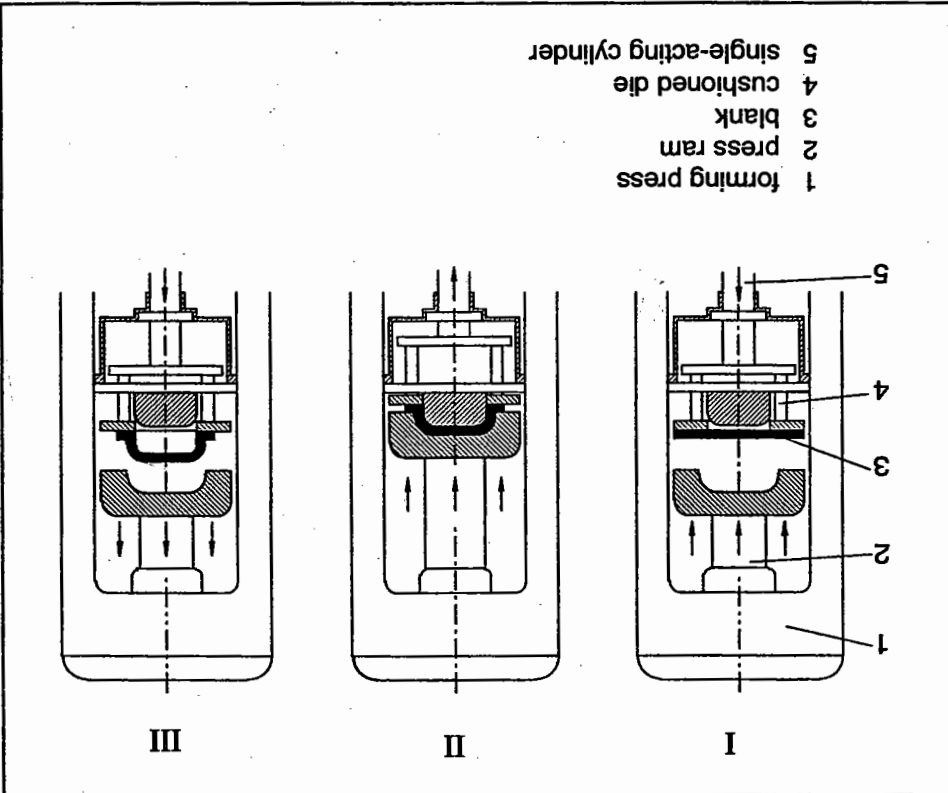

This exercise only looks at the actuation of the die cushioning cylinder, and pays no attention to actuation of the press ram.

As the piston rod of the die cushioning cylinder is forced back by the press during the forming process, the pump must be protected against the return oil flow by a non-return valve. The oil then flows off via the pressure relief valve. The pressure at the pressure relief valve should be set just high enough to ensure that the die cushioning cylinder is pressed up and held in the "up" position with the blank.

If – as required in this exercise – the drive component has to achieve a specific end position in the initial position of the system, valves with spring return action are used. This ensures that the cylinder remains in (or drives to) the desired position when the control is switched on. The normal position of the valve must be selected in line with the task definition.

The die cushioning cylinder can also be retracted without using the force of the press ram by switching off the pressure. The weight of the die is then sufficient to overcome the remaining friction force.

Hydraulic control

Conclusions

- In the first part of the exercise the input signal in the hydraulic section of the control is to be reversed. The die should be advanced in its initial starting position. The normal position of the control valve must be selected accordingly.
- In the second part of the exercise, signal reversal is to be effected electrically. In this case, a 3/2-way solenoid valve is used with port P blocked and A to T open in the normal position.

Activation of the die cushioning cylinder

To facilitate setting operations, it must be possible to retract the die cushioning cylinder – which is advanced in its initial position – by holding down a push-button. The die cushioning cylinder (single-acting cylinder) is actuated using a 3/2-way solenoid valve. As the advanced piston rod retracts when a push-button is pressed, we speak of reversal or negation of the input signal.

Logic functions
Identity

Electrical control

In Exercises 4.1 and 4.2 the input signal of the push-button resulted in an output signal of identical orientation. The corresponding logic function is called identity.

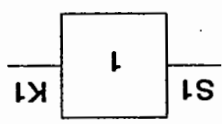
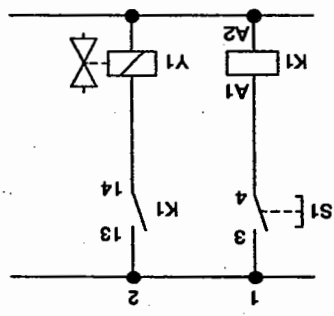
<p>truth table</p> <table border="1" style="margin: auto;"> <tr> <td style="padding: 5px;">S1</td> <td style="padding: 5px;">K1</td> <td style="padding: 5px;"> </td> <td style="padding: 5px;">1</td> <td style="padding: 5px;">1</td> </tr> <tr> <td style="padding: 5px;">0</td> <td style="padding: 5px;">0</td> <td style="padding: 5px;"> </td> <td style="padding: 5px;">0</td> <td style="padding: 5px;">0</td> </tr> <tr> <td style="padding: 5px;">1</td> <td style="padding: 5px;">1</td> <td style="padding: 5px;"> </td> <td style="padding: 5px;">1</td> <td style="padding: 5px;">1</td> </tr> </table>	S1	K1		1	1	0	0		0	0	1	1		1	1	<p>logic symbol</p> 	<p>Boolean equation</p> $K1 = S1$
S1	K1		1	1													
0	0		0	0													
1	1		1	1													
<p>circuit diagram</p> 																	

Identity

This exercise requires reversal of the input signal. This function is called negation. In the circuit symbol, negation is identified by a circle.

Negation

Negation

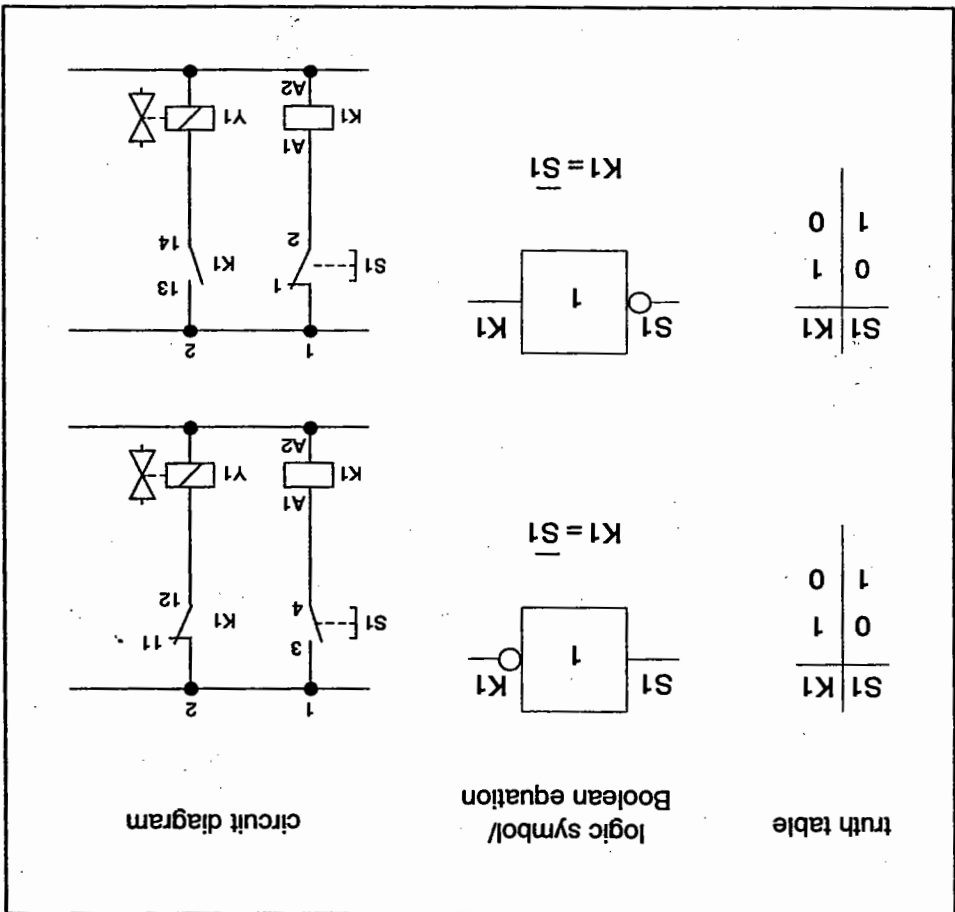

In your solution, pay attention to the guidelines on the drawing of circuit diagrams. Note



Carrying out the exercise
1st step

Circuit with signal reversal
in the hydraulic section

Draw the hydraulic and electrical circuit diagrams with signal reversal in the
hydraulic section of the control.

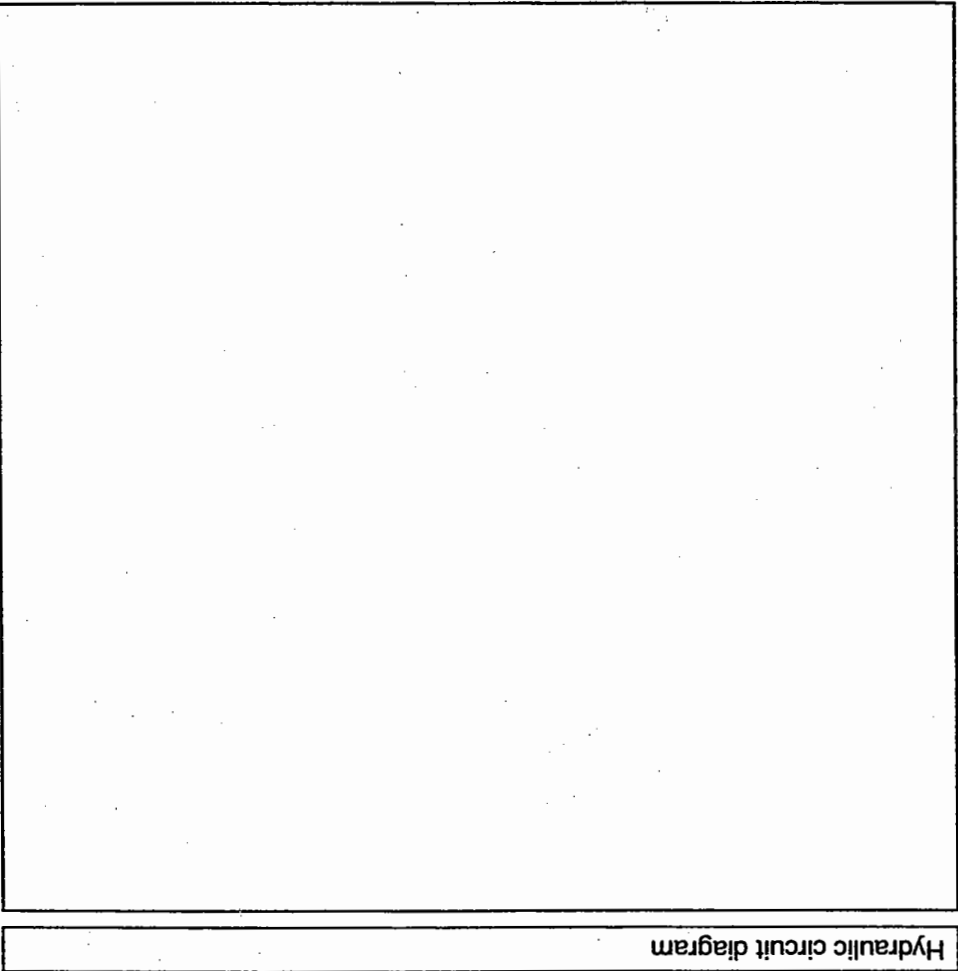

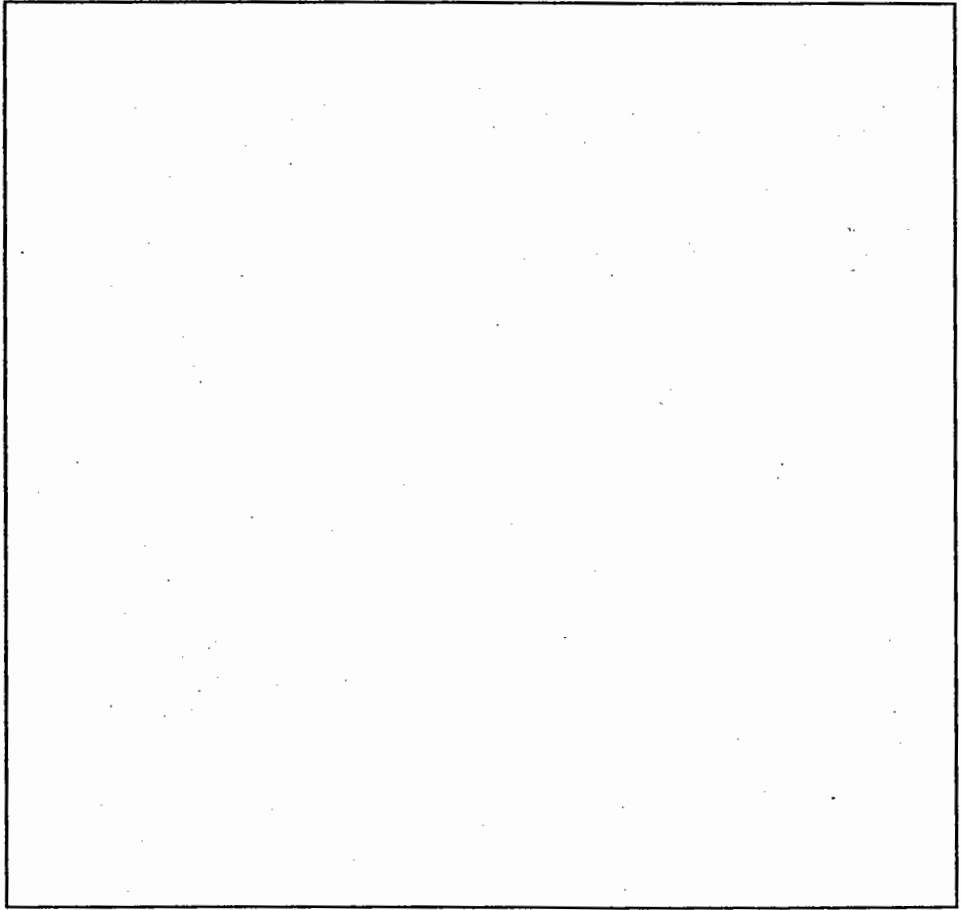

Electrical circuit diagram

2nd step

Circuit with signal reversal
in the electrical section

Draw the hydraulic and electrical circuit diagrams. Signal reversal should now
be effected in the signal control section, in other words in the electrical section
of the control.

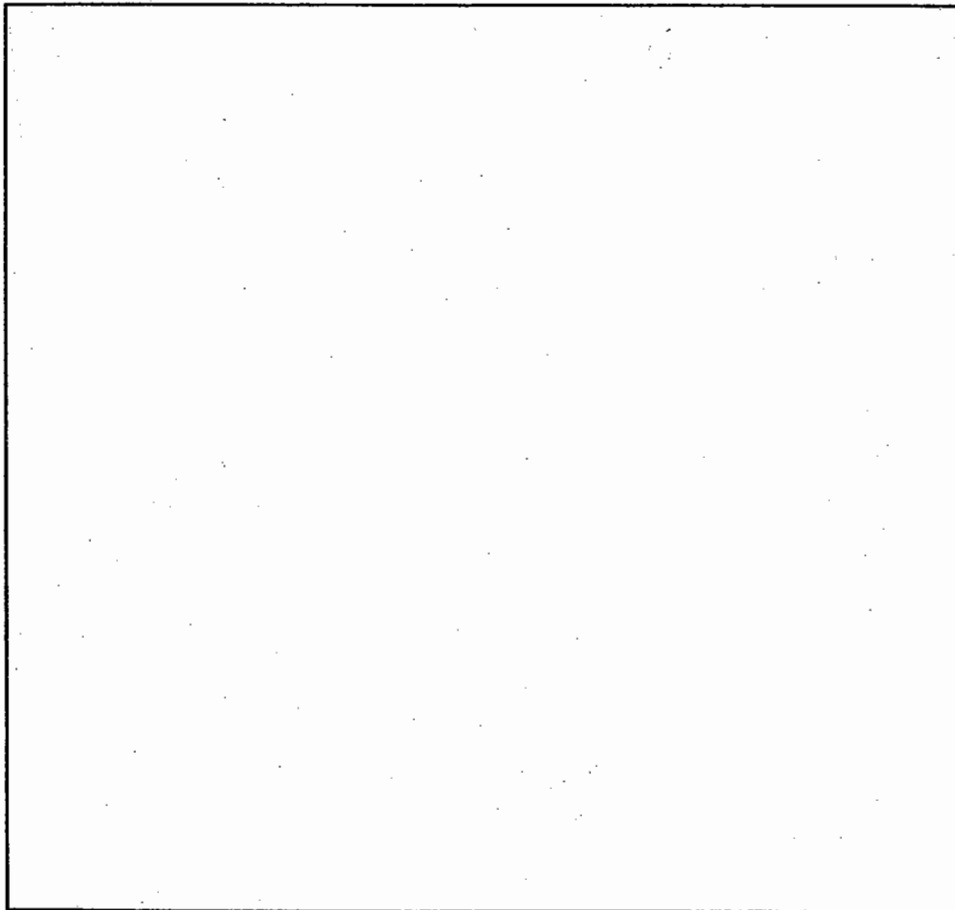

Hydraulic circuit diagram

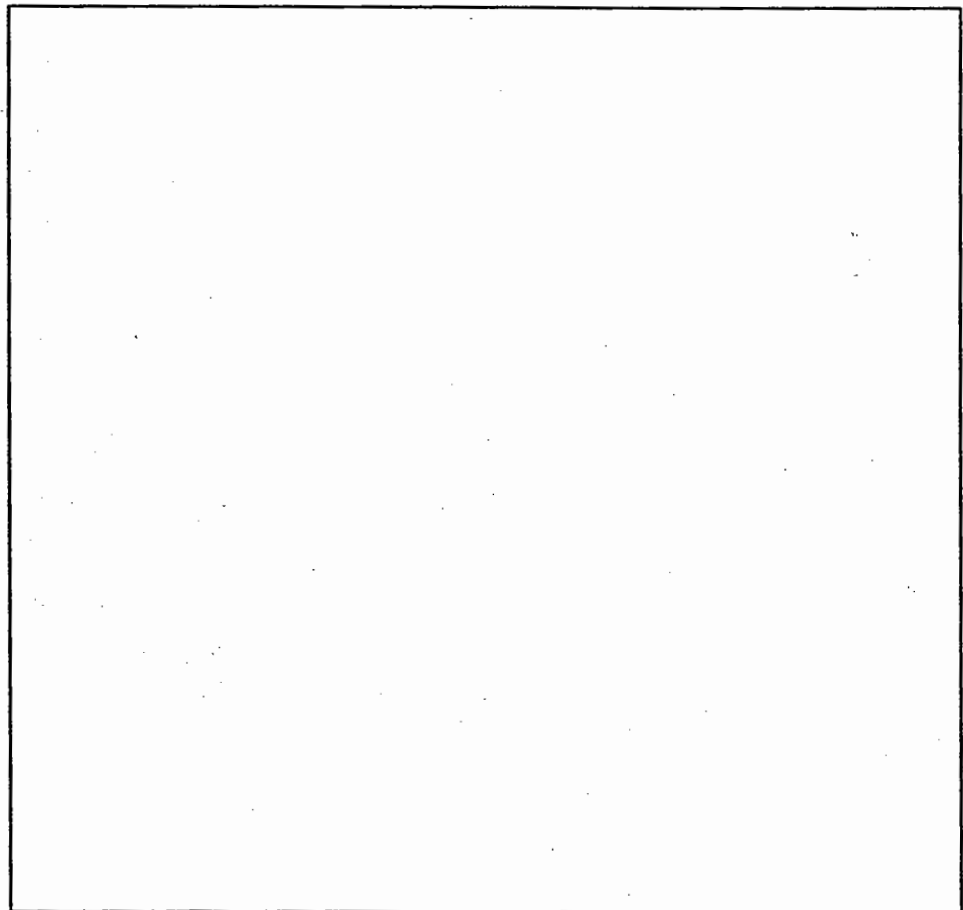

Electrical circuit diagram



Actuation of a double-acting cylinder

Chapter 5



5.1 Exercise 4

Problem definition

In the preceding exercise, (Chapter 4.3) the die was pushed up by a single-acting cylinder. In this exercise, we will be looking at a press in which the force is not sufficient to push the piston rod of the die cushioning cylinder back up. It is therefore necessary to use a double-acting cylinder. The following conditions remain the same:

- at standstill and when the master switch is switched on (initial position), the die cushioning cylinder should be in advanced position.
- during setting operations, a push-button (S1) must be pressed until the piston rod has retracted.

The double-acting cylinder for actuation of the die is actuated by a 4/2-way solenoid valve.

In this exercise, reversal of the input signal should first be effected in the electrical section of the control. In a further exercise, the circuit diagrams for signal reversal in the hydraulic section of the control are to be drawn.

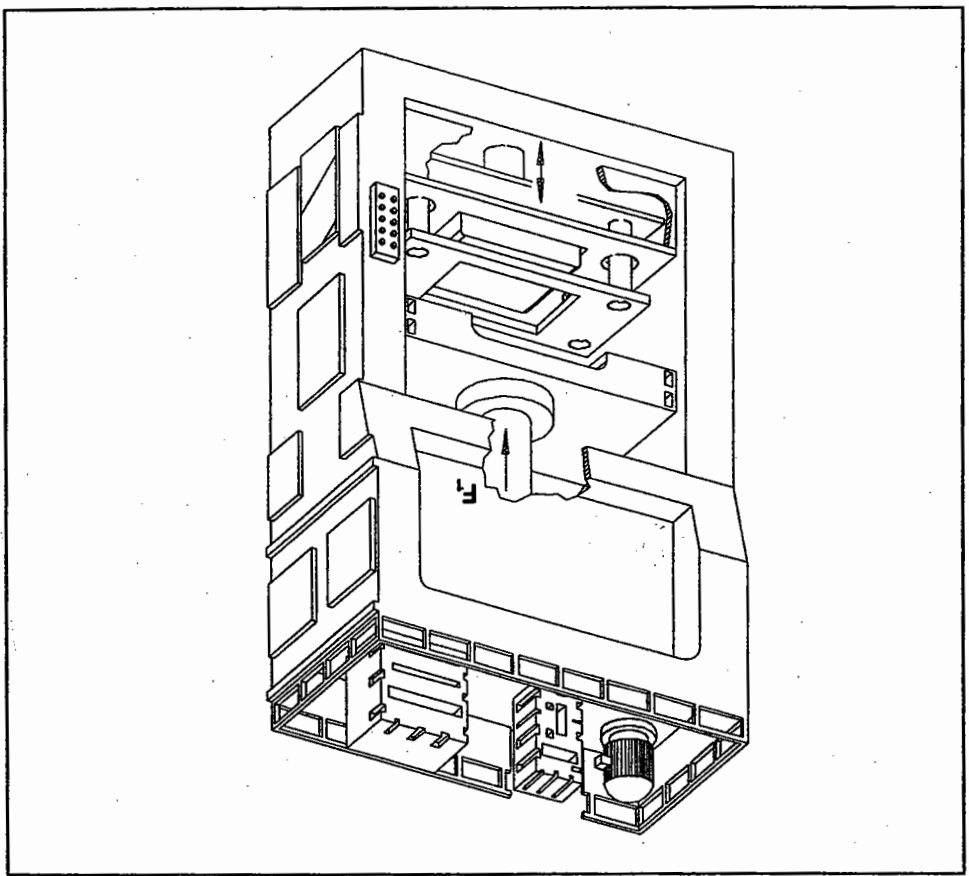

Positional sketch

The 4/2-way valve shown is activated electromechanically and returned by spring action. The attached D.C. solenoid is a "magnet which switches in oil" (wet magnet). The armature also operates in oil and ensures low wear, excellent heat dissipation and a cushioned armature stop. The armature chamber is connected to the tank port. The valve has two power ports A and B, a pressure port P, and a tank port T.

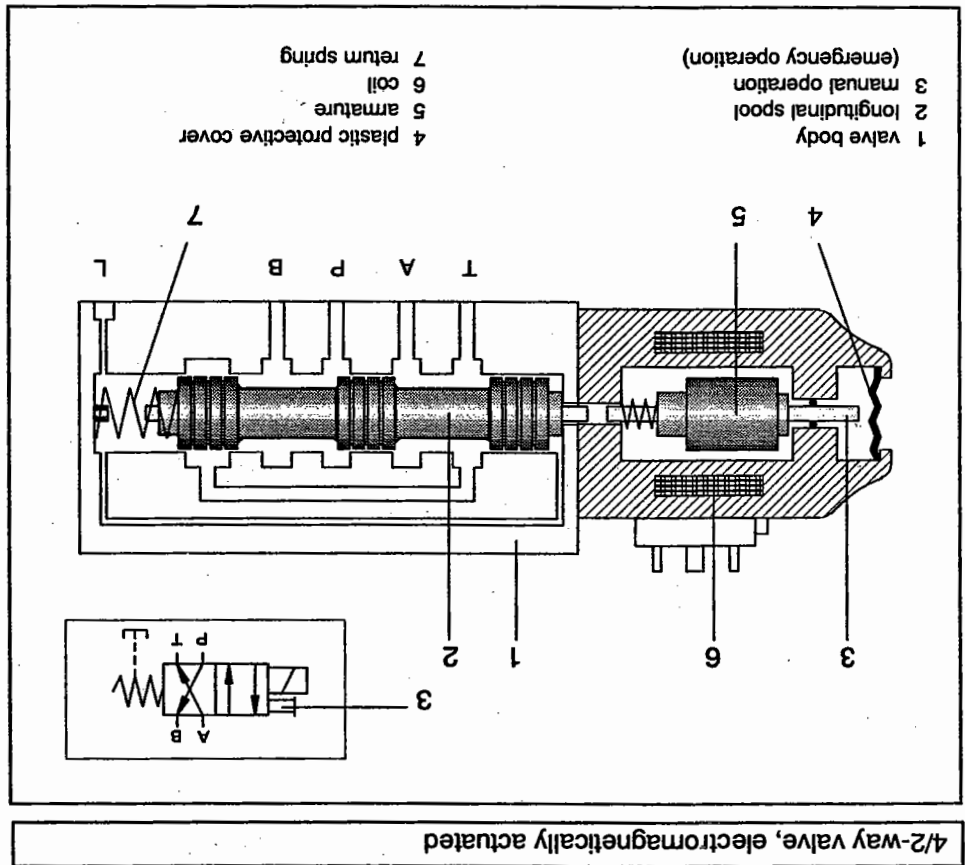

To allow the die cushioning cylinder to advance and retract and to operate hydraulically in both directions, a double-acting cylinder is used. Direction reversal from advance to retraction is effected by the switching of a 4/2-way solenoid valve. If, as required in this exercise, the drive component is to be in a specific end position in the initial position of the system, a valve with spring return motion is used.

Hydraulic control

Conclusions

4/2-way solenoid valve

Carrying out the exercise
1st step

Complete the hydraulic circuit diagram and draw the electrical circuit diagram. Remember that in this part of the exercise signal reversal is to effected in the signal control section.

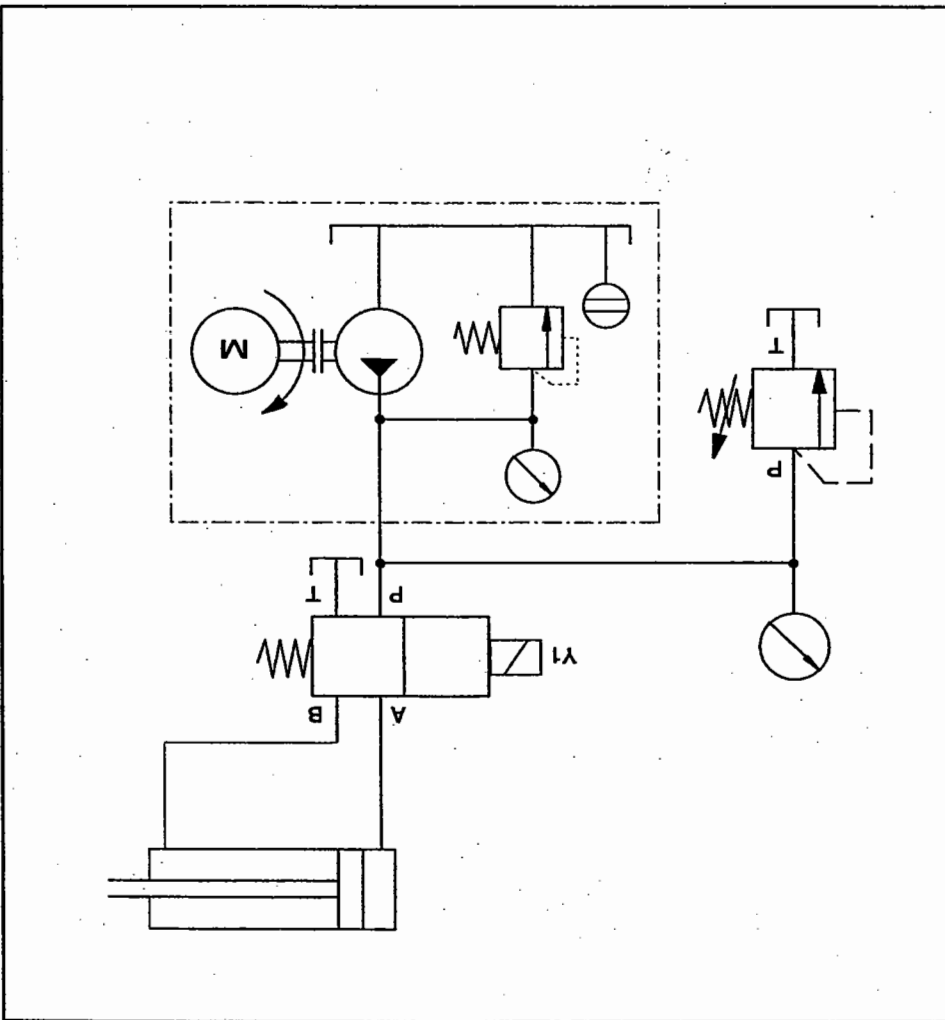

Hydraulic circuit diagram

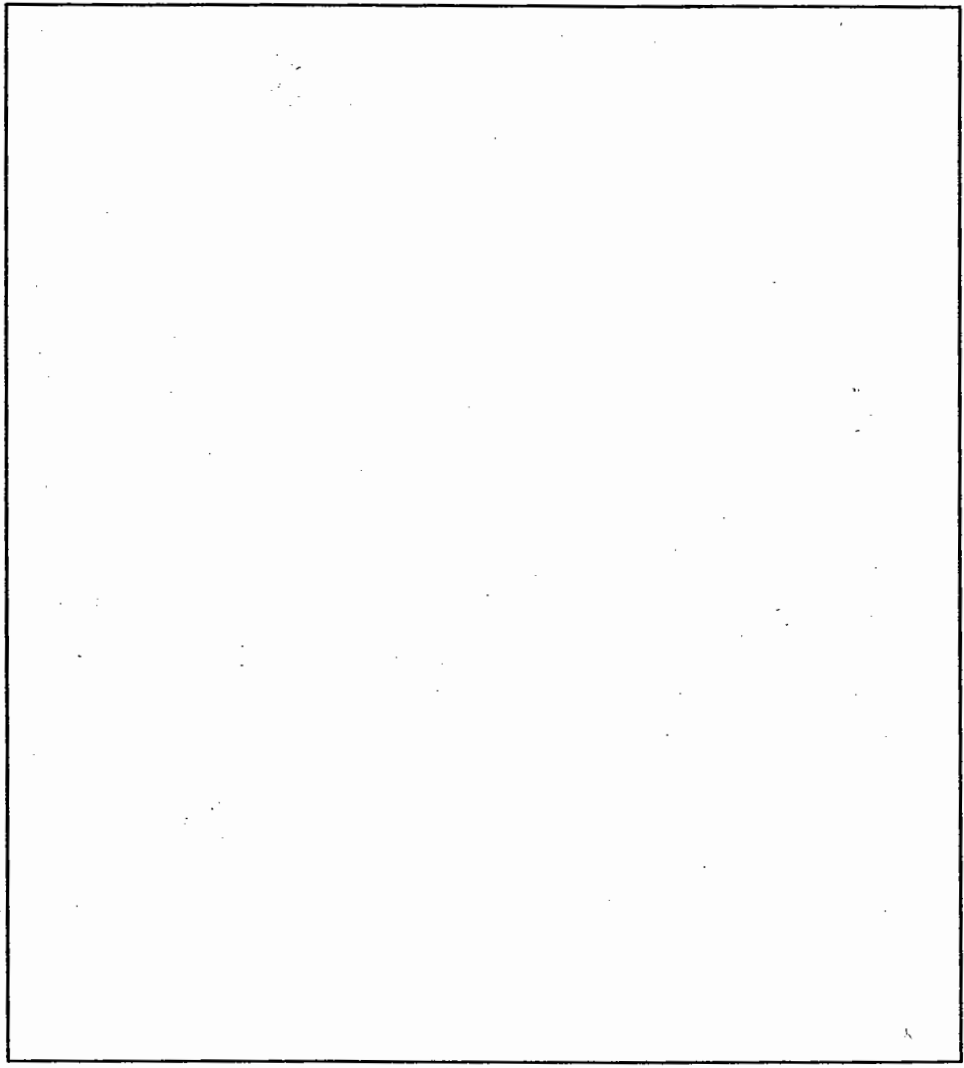

Electrical circuit diagram

2nd step
Additional exercise

Signal reversal should now be effected hydraulically. Draw the hydraulic and electrical circuit diagrams. As in the preceding problem, the directional control valve has the following starting position: flow from P to B and from A to T.

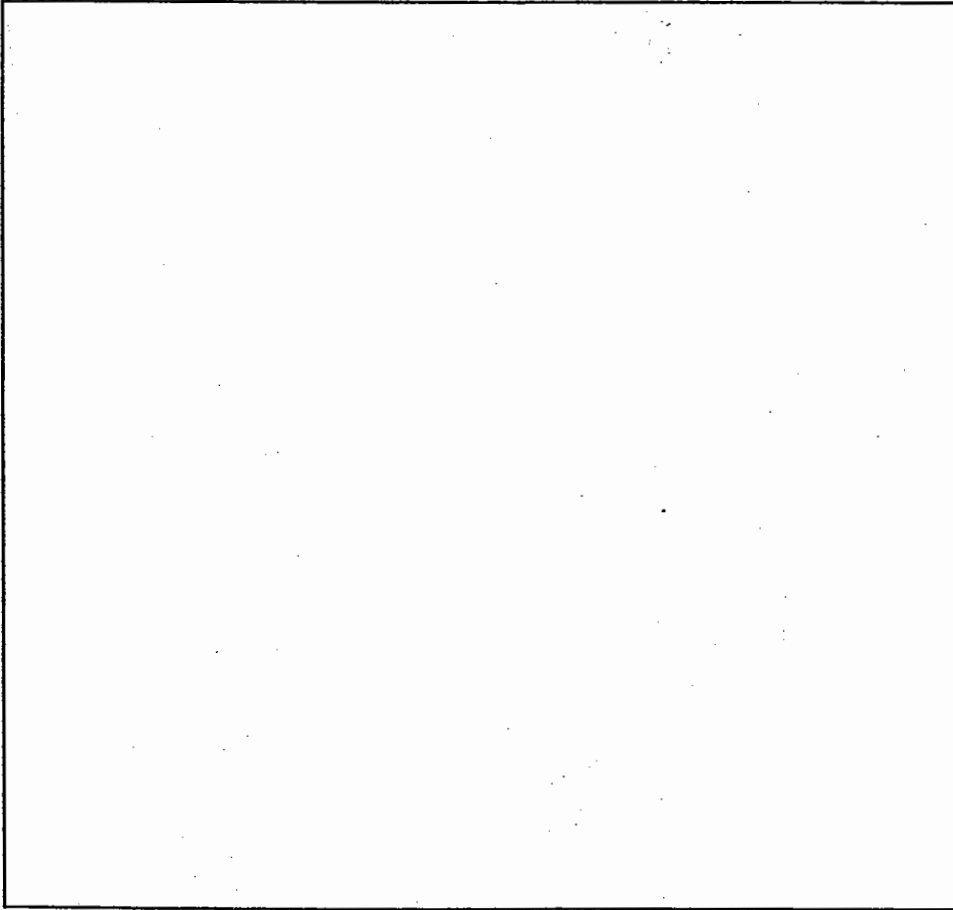

Hydraulic circuit diagram

What happens when the supply voltage to the signal control section fails:

- in the case of electrical signal reversal?
- in the case of hydraulic signal reversal?

3rd step

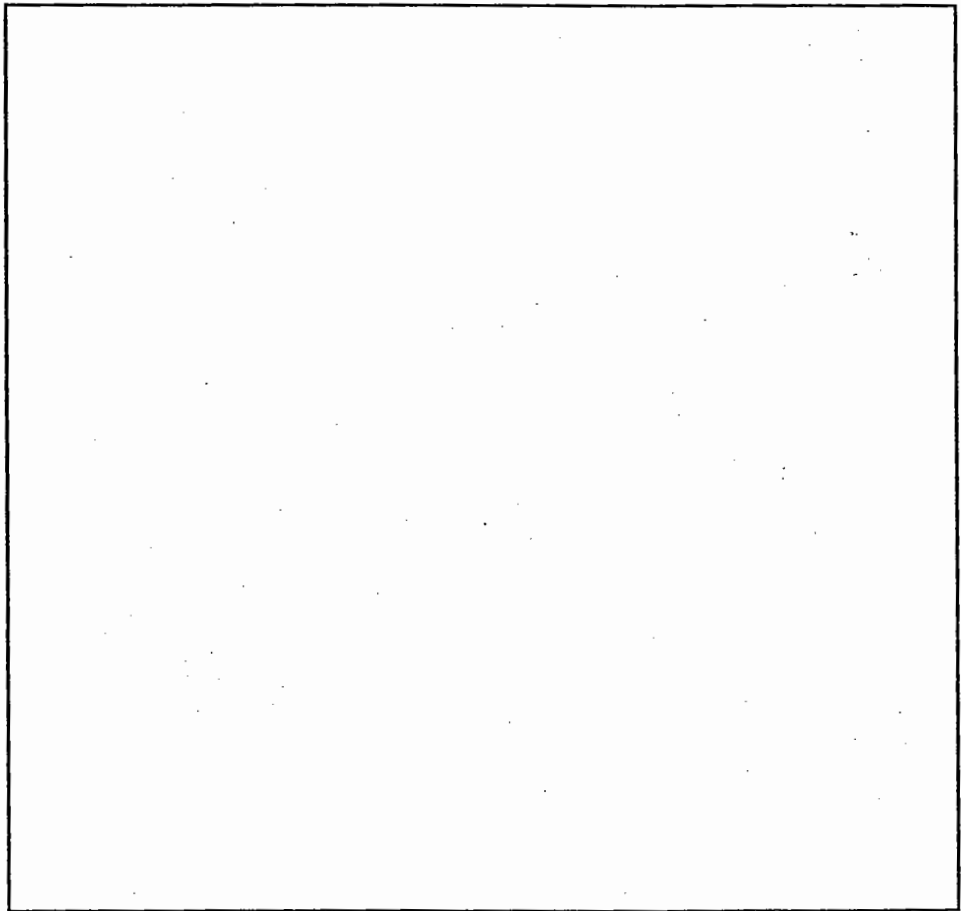

Electrical circuit diagram

Logic operations

Chapter 6



Basic logic functions of Boolean algebra

Logic operations are functions which link binary signals according to the rules of Boolean algebra. Four basic logic operations are available for this purpose:

Identity	Input and output signal have the same status.
Negation (NOT)	The output signal has the opposite value to the input signal.
Conjunction (AND)	The output signal only has the value 1, if all input signals have the value 1.
Disjunction (OR)	The output signal has the value 1, if at least one of the input signals has the value 1.

All other operations, such as NAND, NOR, EXOR, EQUIVALENCE, ANTI-VALENCE etc. can be put together from these basic logic functions.

Conjunction (AND function) and negation (NOT function)

Problem definition

6.1 Exercise 5

In die-casting operations, extremely high pressures occur in the closed mould. To cope with these pressures, the mould closure is fitted with a toggle fastener. The toggle fastener is actuated via a double-acting cylinder.

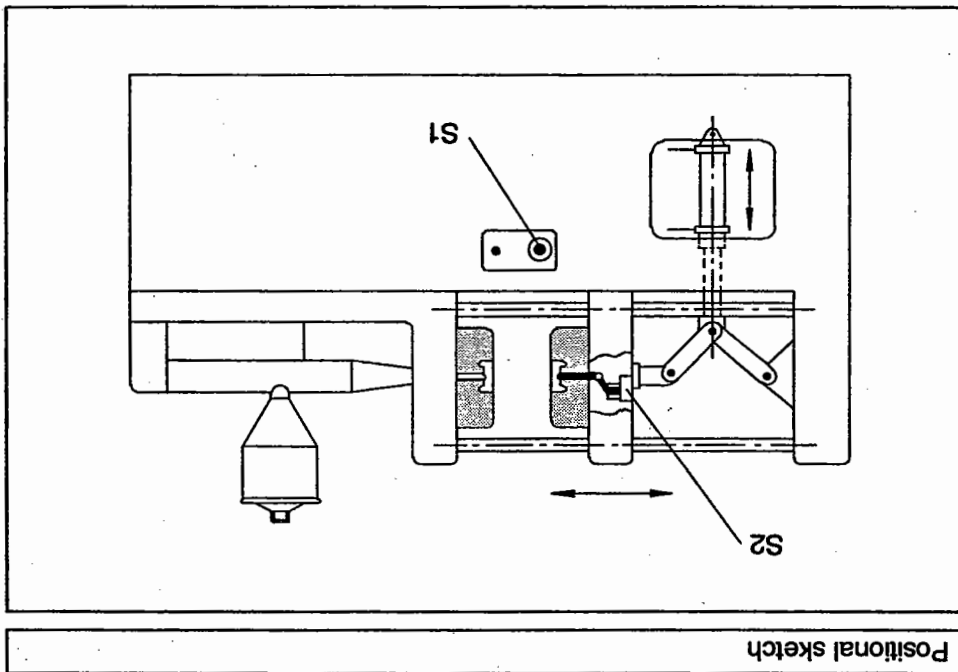

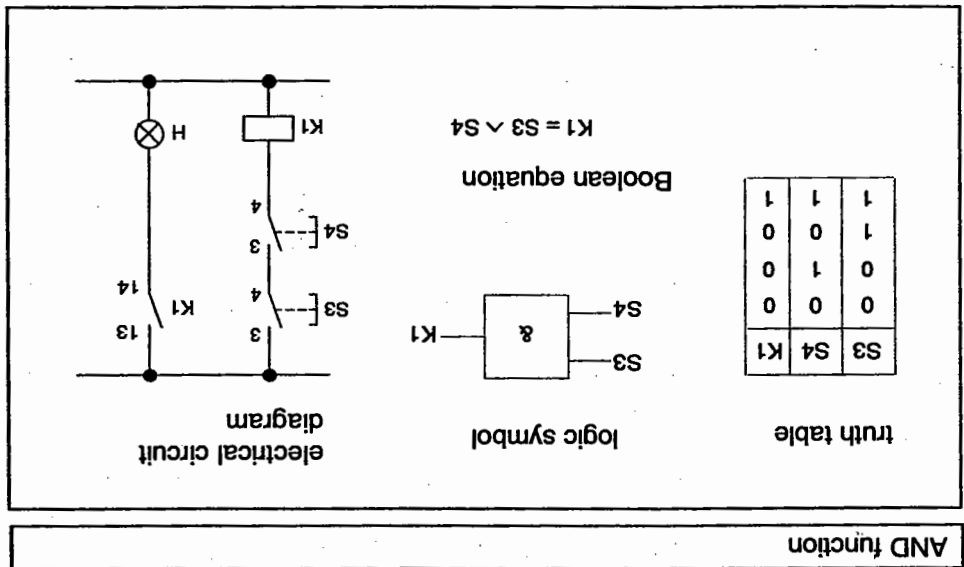

If two signals are interlinked with the result that a current only flows if both signals are present (= 1), we speak of an AND logic function. In the field of electrical engineering, this is effected by series connection of the corresponding input elements.



NOT function

The signal "Moulded part in place" is ascertained by limit switch S2. As startup is only possible when no moulded part is in the mould, this signal must be reversed. The reversal of a signal is also known as a NOT logic function (Negation) (see Exercise 3). In the electrical section of the control, the NOT operation is effected by a normally closed contact.

Conclusions

The signals coming from the signal input elements

- "Push-button ON" (S1) and
- "Moulded part in place" (S2)

are to be interlinked in accordance with the task definition.

If a part is not present in the mould, the mould should close when push-button S1 is held down. When the mould is closed, the automatic injection process begins. The finished part actuates limit switch S2, and the mould opens again. The process cannot be repeated until the part has been removed.

Carrying out the exercise
1st step

Draw the hydraulic circuit diagram and identify the elements. Use a 4/2-way valve to actuate the cylinder.

Hydraulic circuit diagram

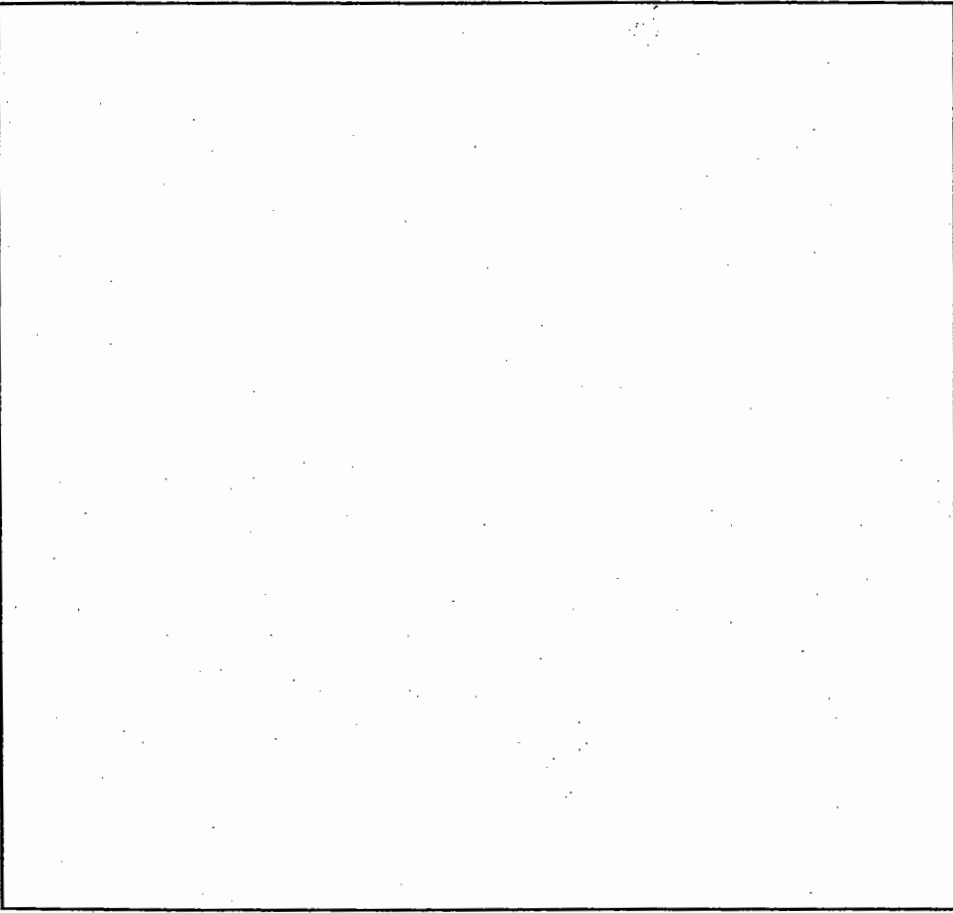

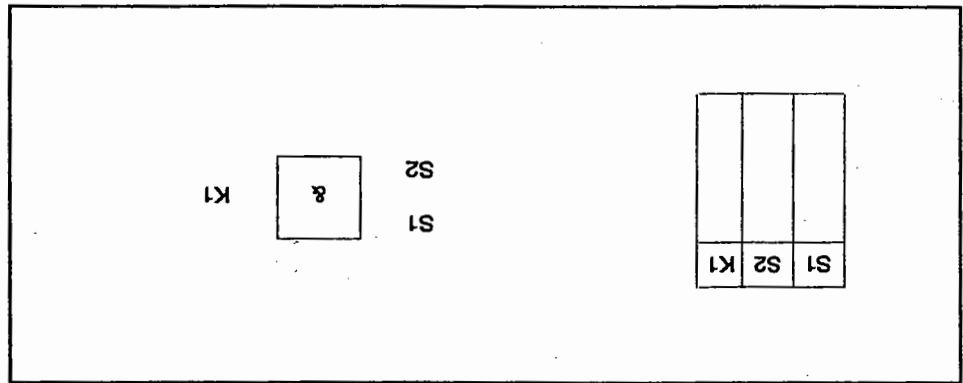

3rd step Complete the truth table and add the symbol for the AND logic function

Item Qty	Description	Type and Standard designation	Manufacturer/Supplier	No.	Alteration	Date	Name	Make	Signed	Date	Order no.	Purchaser	Group of Sheets	Drawing no.	Sample parts list of a hydraulic system	Inventory no.	Type	Tested	

2nd step Draw up the parts list for the hydraulic control.

Please complete the electrical circuit diagram on the basis of logic interlinking of signals S1 and S2 and the cylinder control described above!

Electrical circuit diagram

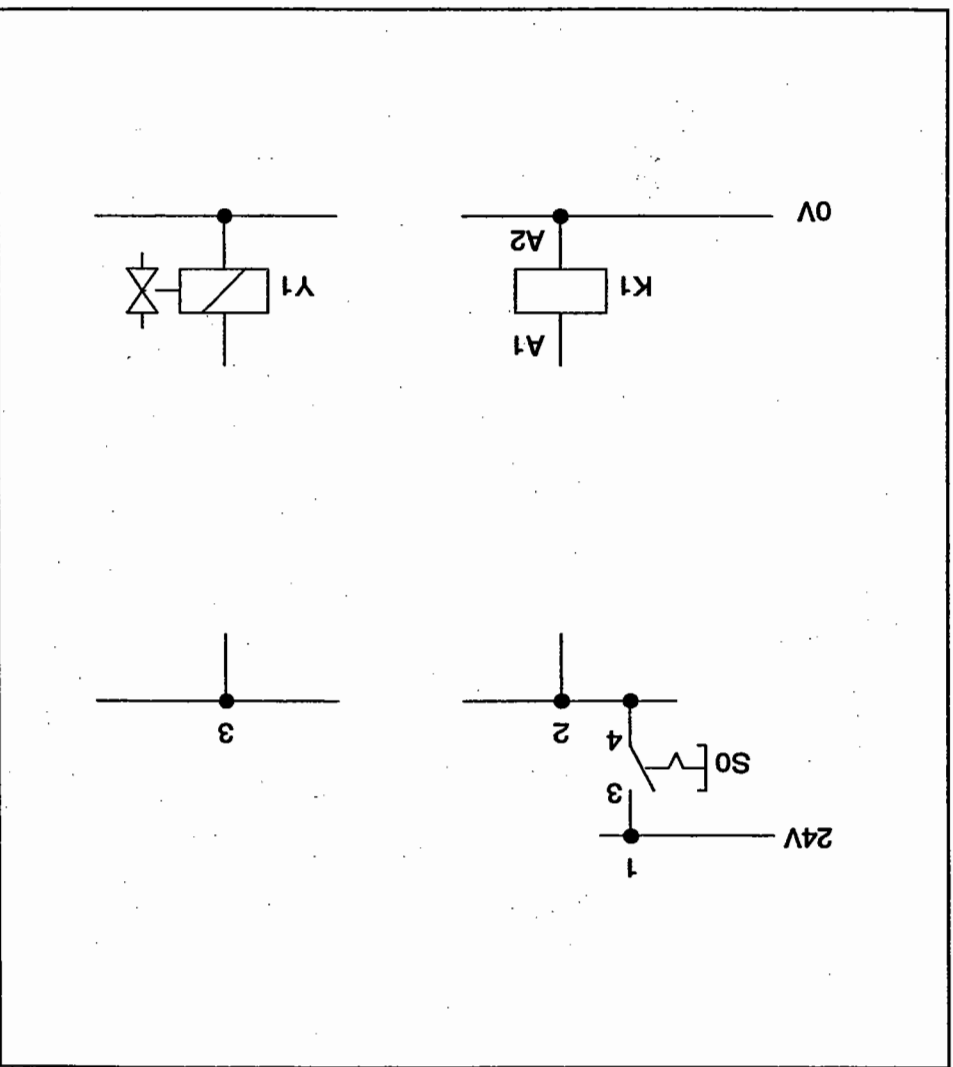

- To ensure that the boiler door does not slam shut, it must be cushioned shortly before final closure.
- This braking function can be performed by a shock absorber (see positional sketch).
- Alternatively, a cylinder with adjustable end position cushioning can be used.

Hydraulic control

Conclusions

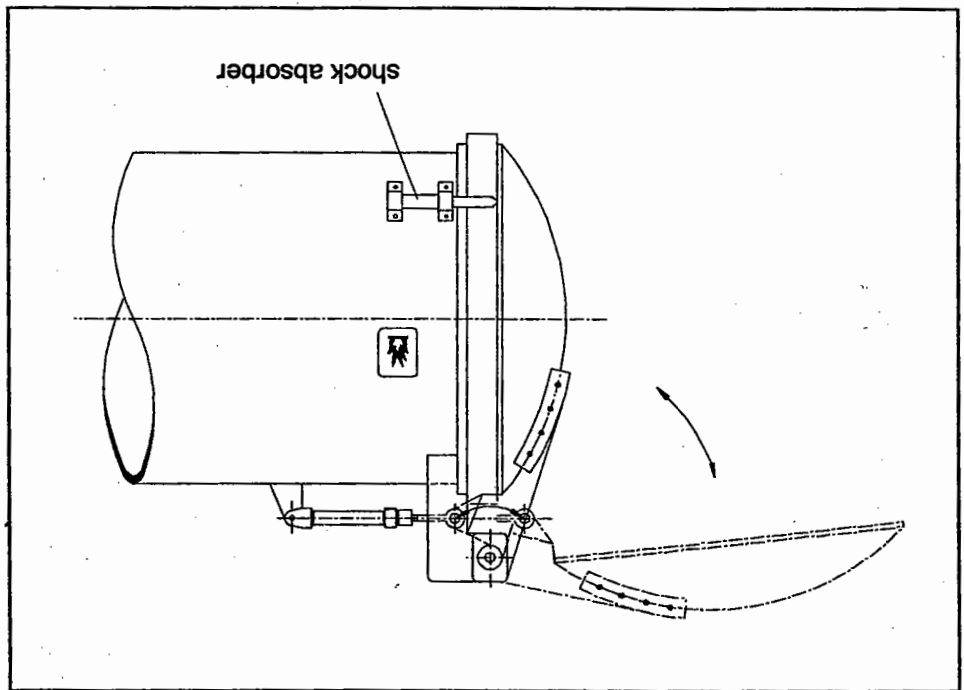

Positional sketch

To insert or remove workpieces, the boiler door of a hardening furnace has to be opened for a short time. The door is opened and closed by a double-acting hydraulic cylinder. Actuation of the cylinder should be possible both by a hand-operated push-button and a foot-operated button. After the appropriate push-button is released, the cylinder should retract and close the boiler door.

Disjunction (OR function)

6.2 Exercise 6

Problem definition

OR function

In line with the task definition, two signal input elements (hand-operated push-button S1 and foot-operated button S2) are to be interlinked in such a way that the cylinder advances when one of the two signal input elements or both push-buttons are actuated. This type of operation is carried out using an OR function.

For electrical realisation of the OR function, the two signal input elements are connected in parallel (see diagram). It can be seen from the value table that current flows through K1 if either one or both of the signal input elements are actuated.

Electrical control

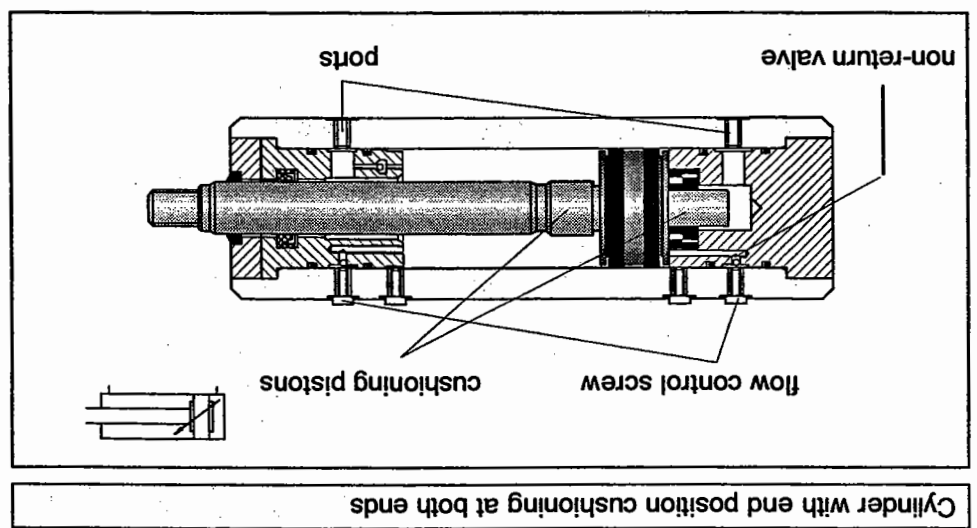
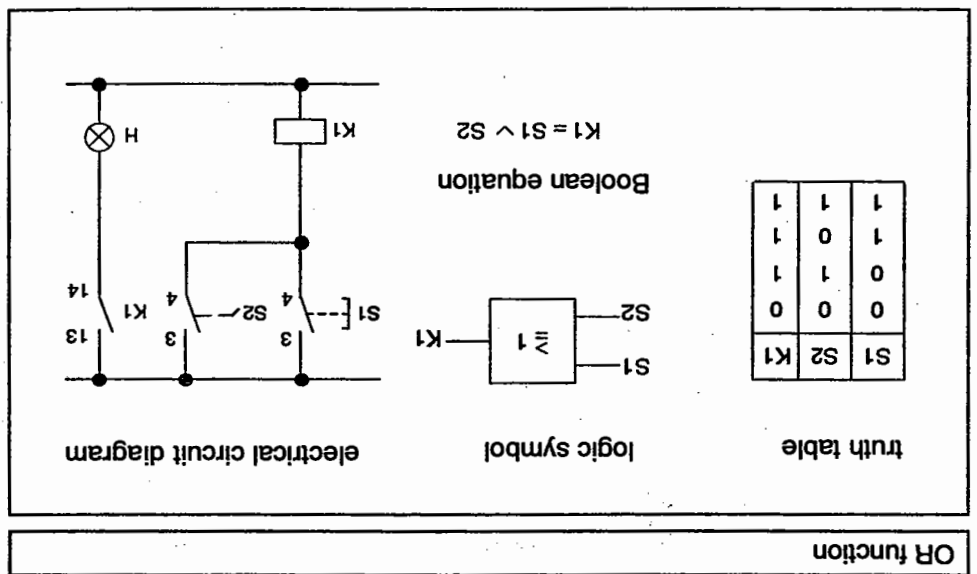

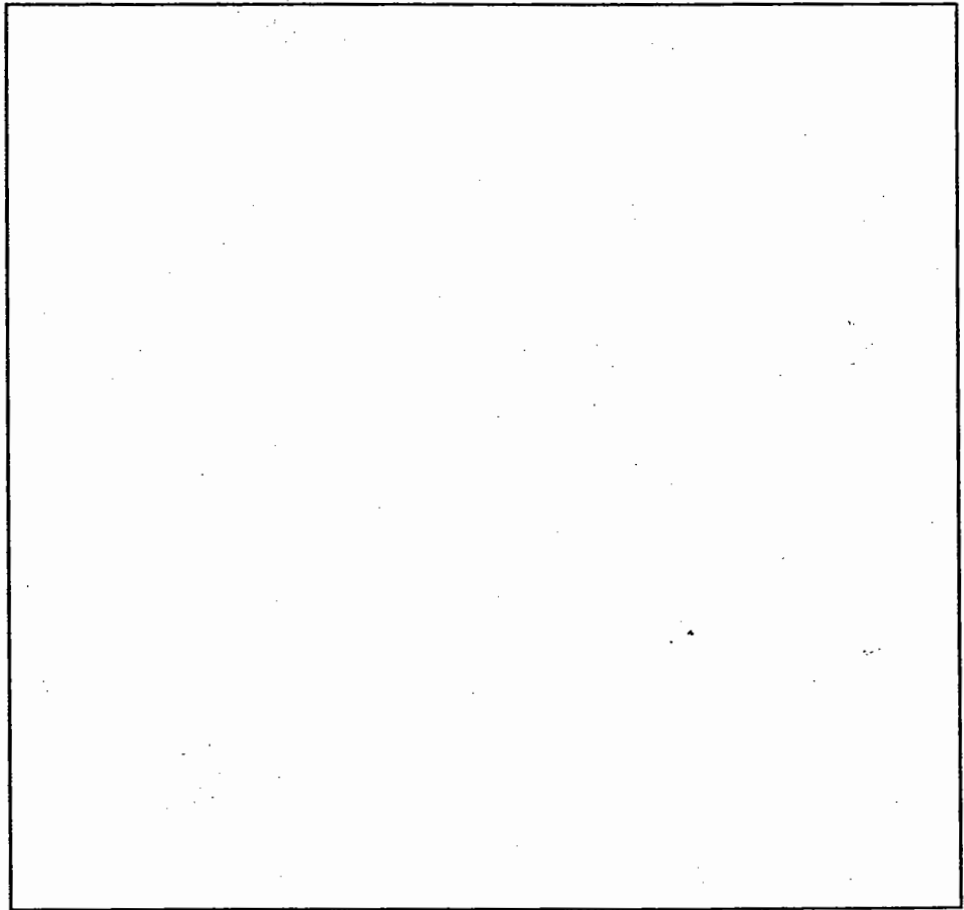

Hydraulic circuit diagram

Draw the hydraulic circuit diagram. The cylinder should be equipped with adjustable end position cushioning in the advanced position.

1st step
Carrying out the exercise

There are two circuit options for an OR circuit. Complete the circuit diagrams in the illustrations accordingly!
 Allocate the designation S1 to the hand-operated push-button and the designation S2 to the foot-operated button.

Electrical circuit diagram

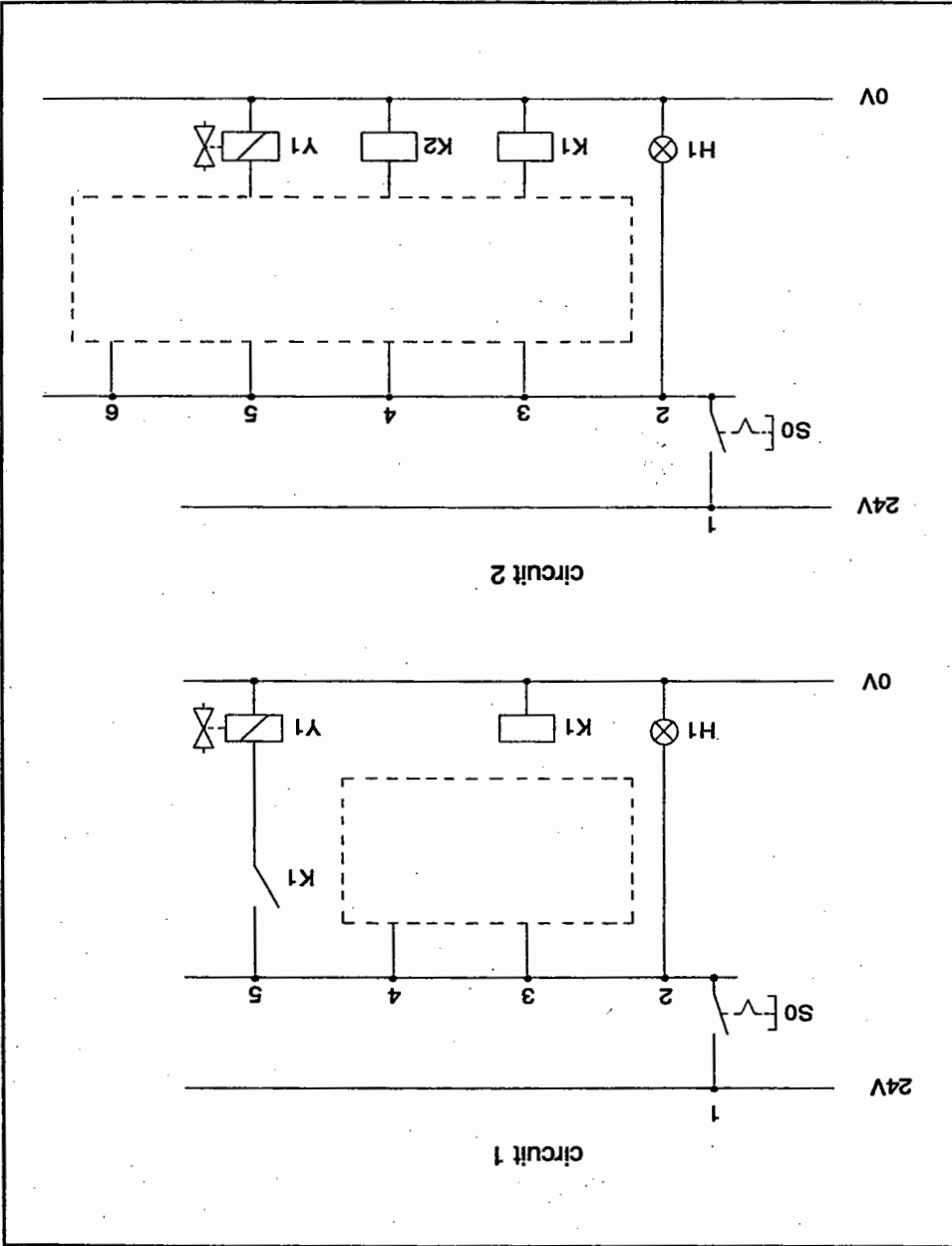

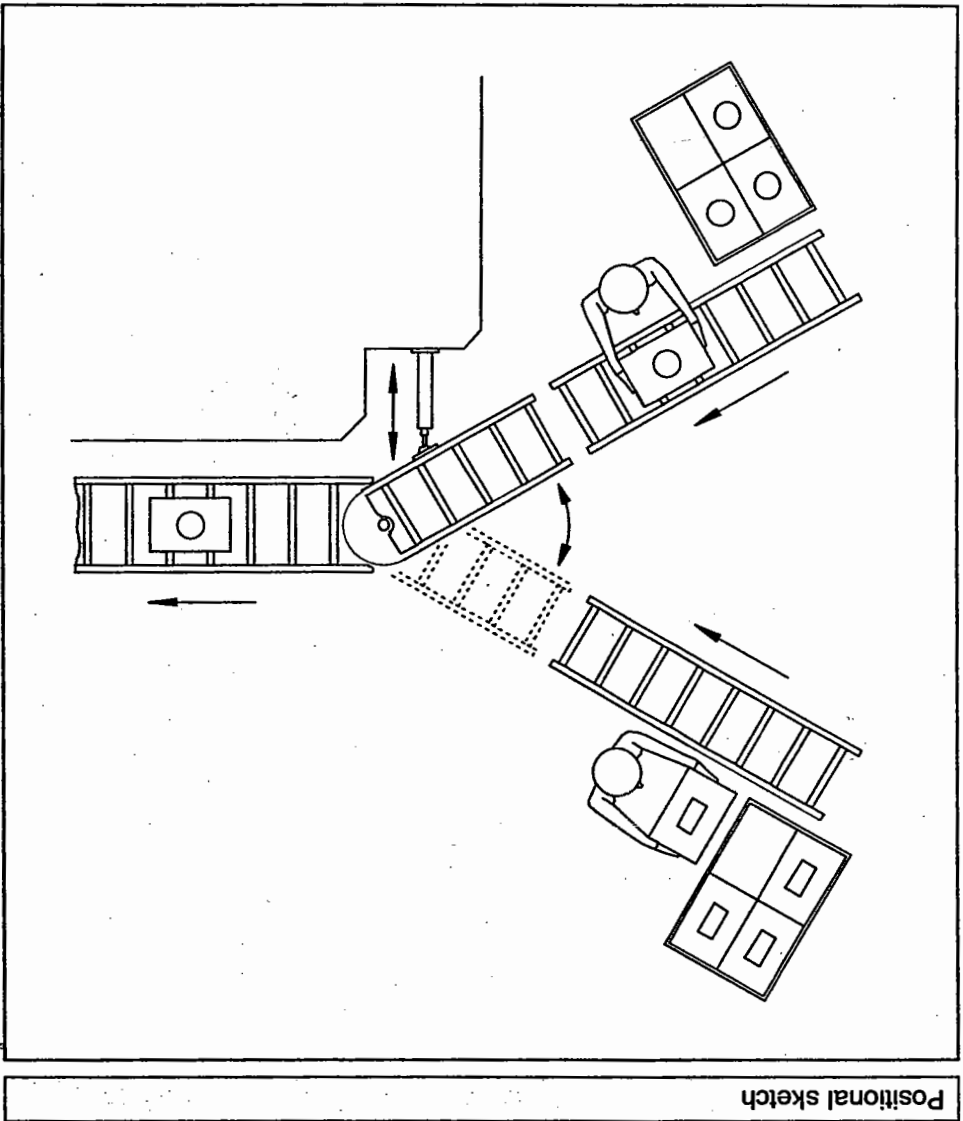

- Two assembly lines travelling towards each other carry workpieces which are to be alternately placed on a conveyor belt.
- It should be possible to effect the swivel motion of the switchover mechanism from both workplaces via a control switch.
- The switchover mechanism is moved back and forth by a double-acting cylinder.

Problem definition

Exclusive OR (EXOR function)

6.3 Exercise 7

Conclusions

Hydraulic control

A 4/2-way valve with spring return is used to actuate the double-acting cylinder. The switching signal must be stored to ensure that the piston rod of the cylinder travels into the forward or retracted end position. The easiest way to store the signal is to use a control switch.

To ensure that it does not travel into the respective end position at full speed, the piston rod of the cylinder must be cushioned. This is effected using a cylinder with end position cushioning at both ends.

Electrical control

It should be possible to activate the swivel motion from two different points; this requires the use of a two-way circuit.

- This two-way circuit can be realised using a switch with changeover contacts at each of the two workplaces.
- Another way to achieve the same result is to use a switch with normally open and normally closed contact at each of the workplaces.
- If the two-way circuit is equipped only with normally open contacts at the signal input element, a relay circuit is additionally required.

Two-way circuit

The basic logic operation for each of these two-way circuits is an exclusive OR.

Exclusive OR

truth table

S1	S2	K1
0	0	0
0	1	1
1	0	1
1	1	0

logic symbol

Boolean equation

$$K1 = (S1 \wedge \overline{S2}) \vee (\overline{S1} \wedge S2)$$

electrical circuit diagram with changeover contacts

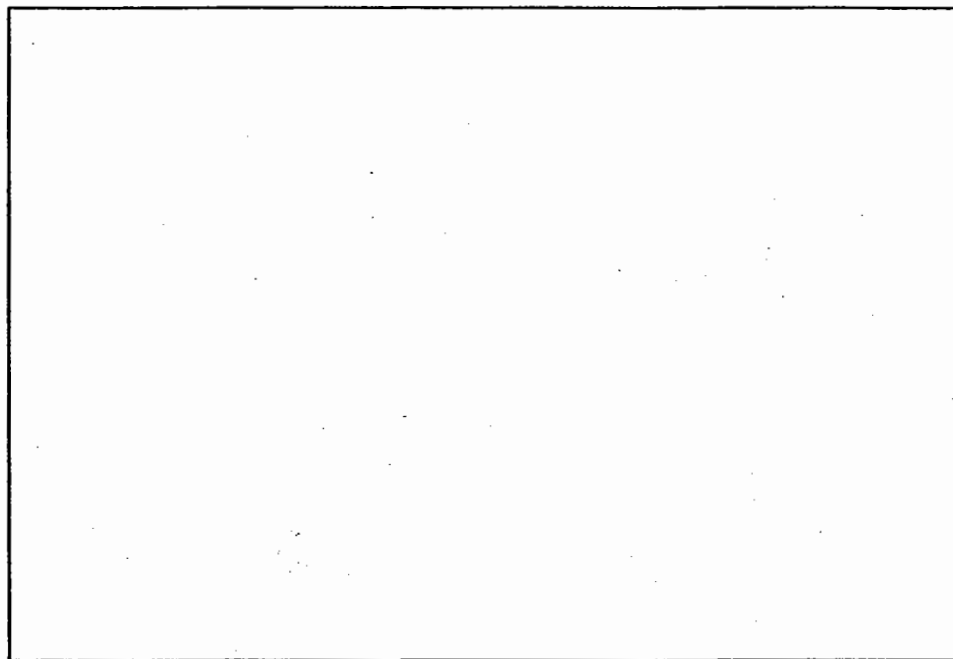

Hydraulic circuit diagram

Draw the hydraulic circuit diagram first. In place of the hydraulic assembly, draw only the symbol for the pressure source.

Carrying out the exercise
1st step

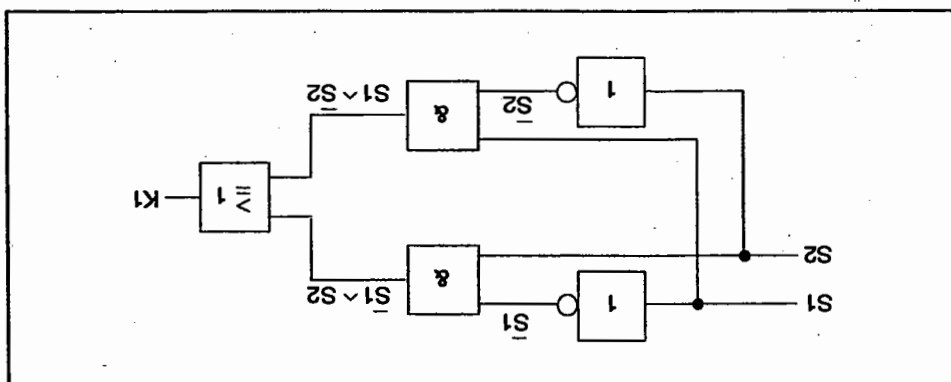

Logic diagram Exclusive OR

- first, the input signals are negated (NOT).
 - then, the input signals and the negation are interlinked via AND.
 - finally, these two expressions are interlinked using OR.
- ram can be derived from the truth table:
and negation (NOT). The Boolean equation and the corresponding logic diagram

2nd step

Initially draw the electrical circuit diagram with two control switches equipped with changeover contacts.

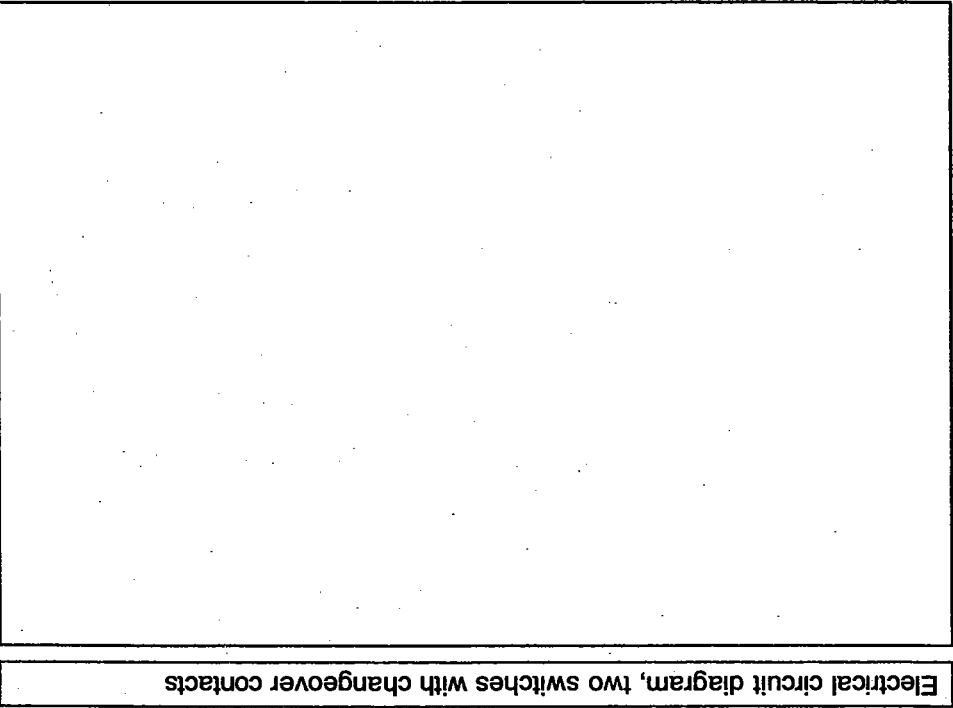

Electrical circuit diagram, two switches with changeover contacts

3rd step

Now draw the electrical circuit diagram with two control switches equipped with only one normally open contact each.

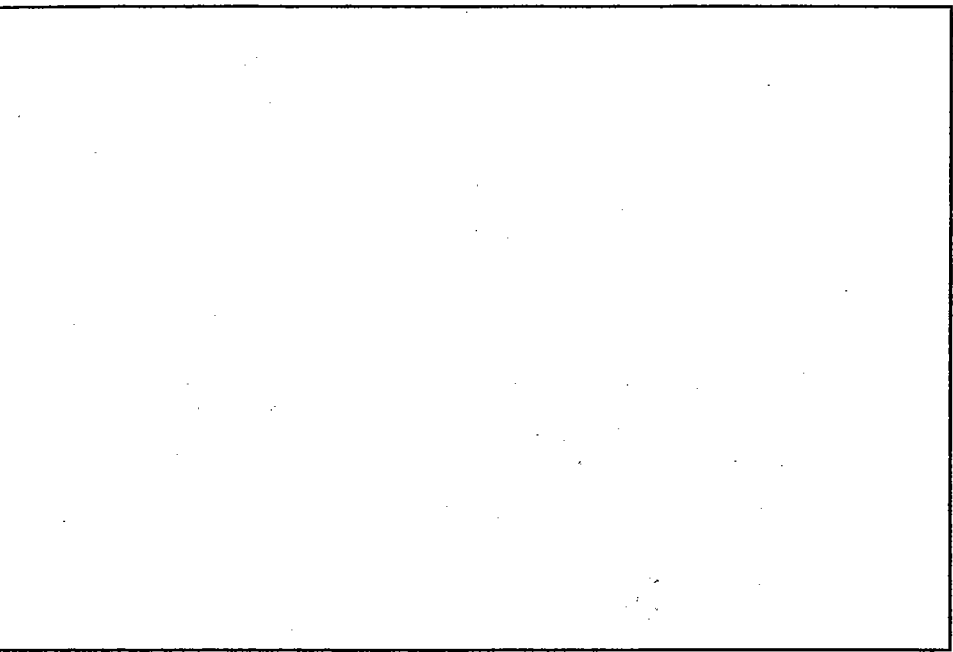

Electrical circuit diagram, two switches with normally open contacts

Signal storage

Chapter 7



7.1 Exercise 8

Problem definition

A signal can be generated electrically, hydraulically or pneumatically. If the signal is only present for a short time, it must be stored for further processing. In electro-hydraulic systems, signal storage can be effected in two ways:

- in the hydraulic power section using double solenoid valves which store the respective position via notch or friction,
- and in the electrical signal control section using control switches or latching circuits.

Signal storage in the hydraulic section

In production systems, workpieces are clamped with the help of hydraulic devices. Easy operation and rapid workpiece change are the two chief requirements. The positional sketch shows a clamping device of the type used in, for example, drilling and milling operations.

The workpieces are clamped using a double-acting cylinder. The operator should control opening and closing of the clamping device via a push-button. When the push-button is released, the piston rod should proceed to the selected end position or on to the workpiece. For safety reasons the valve must not change its switching position in the event of a power failure. If the close or open push-button is pressed, the inverse signal must not become effective. The push-buttons must therefore be interlocked.

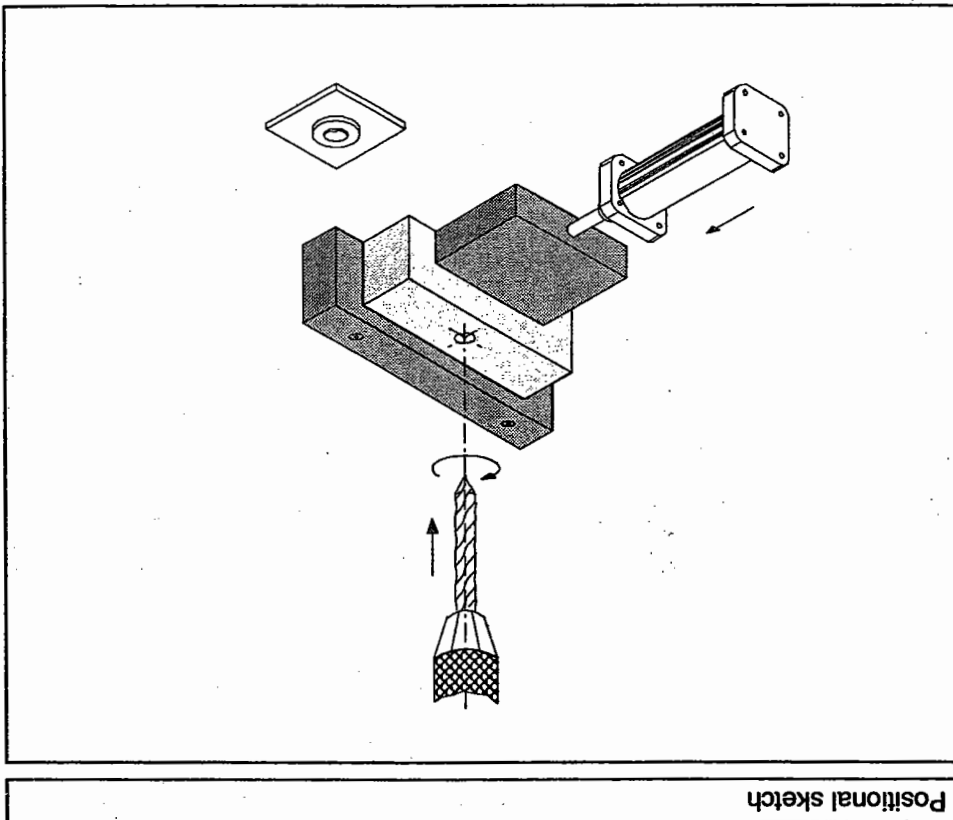

Positional sketch

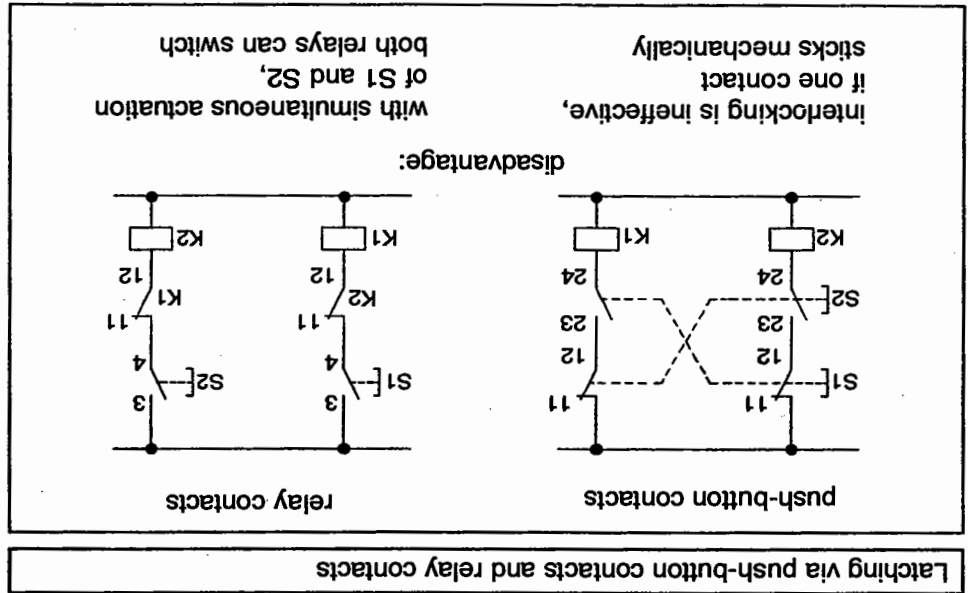

To ensure that only one coil of the solenoid is actuated, the two input signals must be interlocked. Interlocking can be effected via the pushbutton contacts or via the relay contacts (contactor contacts).

Electrical control

Double solenoid valves require an electrical switch-over pulse for each switching position. The switching position is stored via friction or notch. The valve does not switch back until an electrical pulse acts on the opposing solenoid coil. If the double solenoid valve is activated by both switching signals, the signal applied first has priority. Double solenoid valves are used wherever it is important that the valve position is retained in the event of control voltage failure (e.g. in clamping devices).

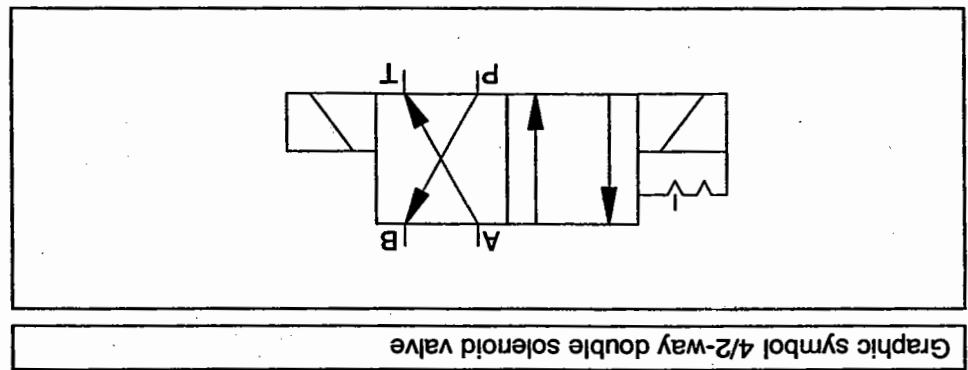

If the piston rod of the cylinder is also to advance to the selected end position when the push-button is released, the switching signal must be stored. Signal storage should be effected in the directional control valve in line with the task definition. A 4/2-way double solenoid valve is used to activate the double-acting cylinder.

Hydraulic control

Conclusions

Double solenoid valve

Draw the hydraulic circuit diagram with the additional condition that the speed of the closing motion can be altered. The opening speed remains unchanged.

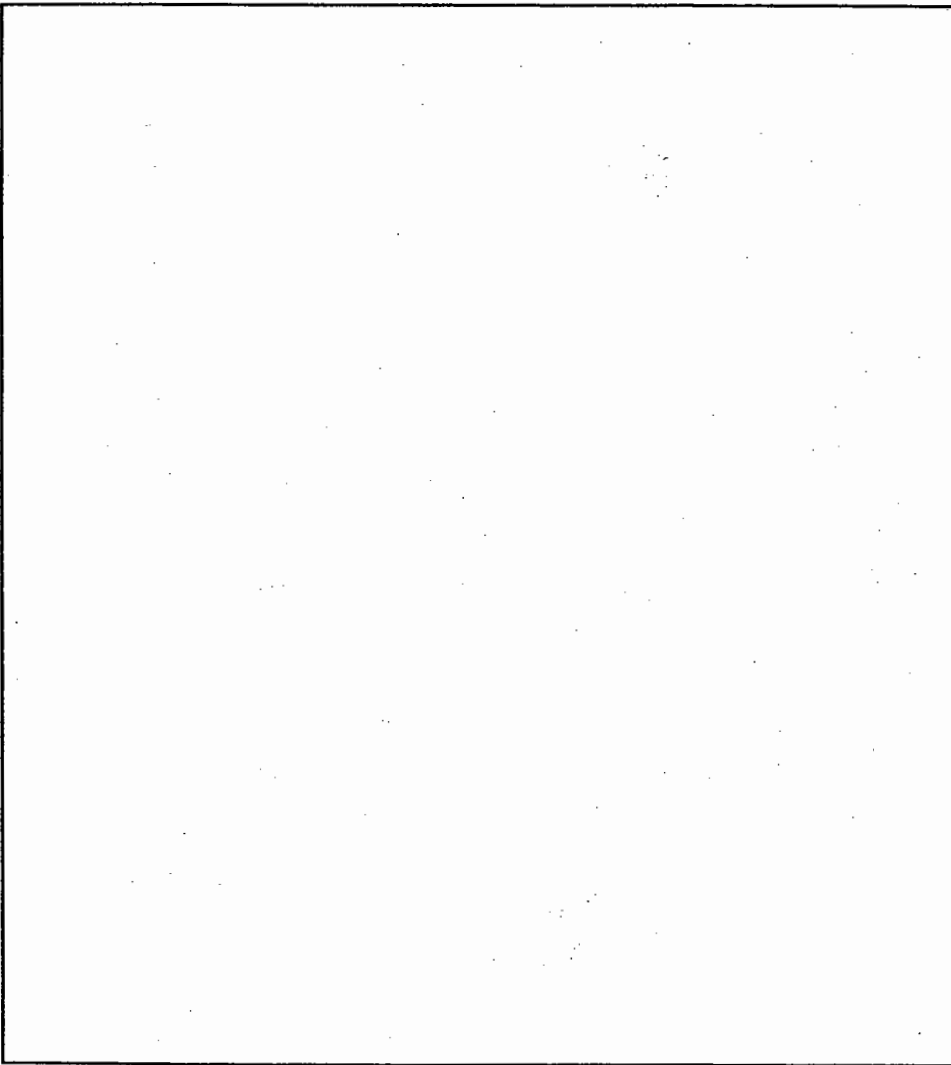

Hydraulic circuit diagram

Carrying out the exercise
1st step



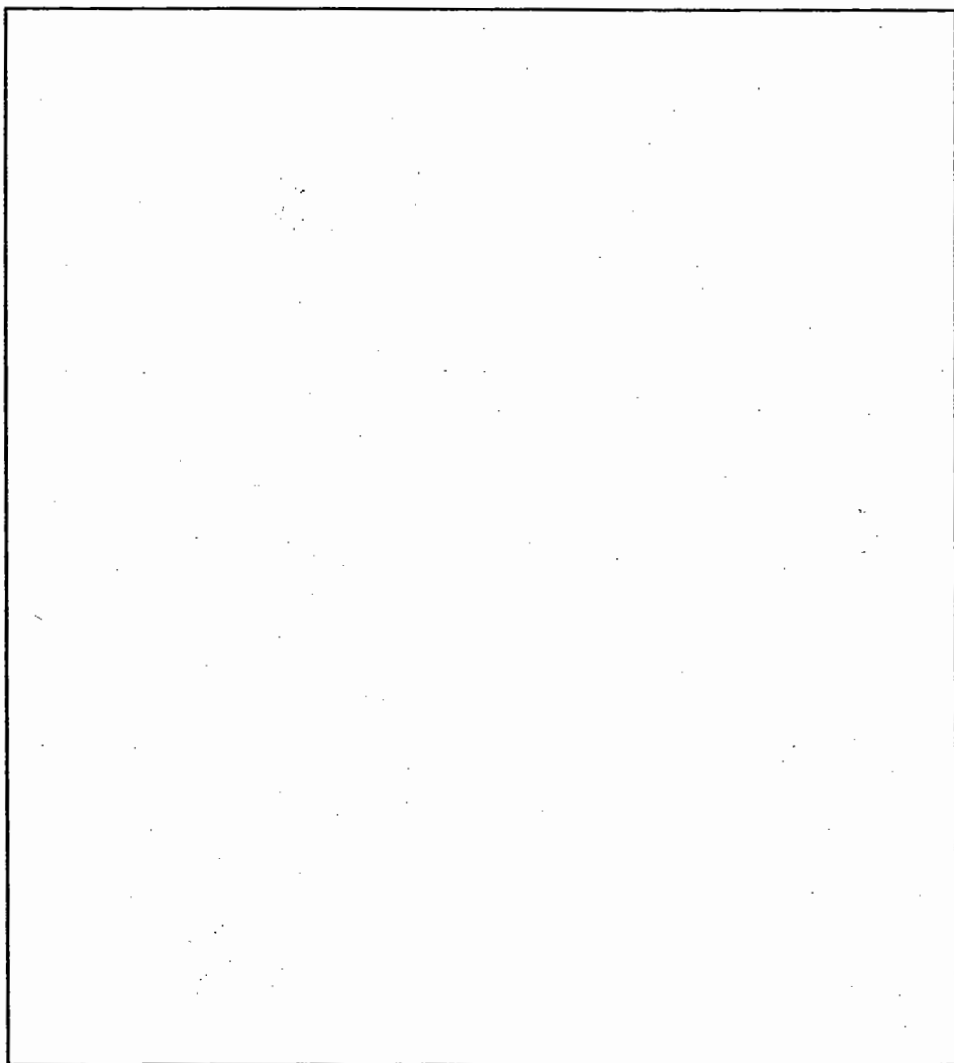

Electrical circuit diagram

Draw the electrical circuit diagram. Electrical activation should be effected indirectly. In addition, the input signals should be interlocked via the push-button and relay contacts.

7.2 Exercise 9

Problem definition

In the preceding exercises, we saw that the piston rod of a cylinder only moved into the respective end position if the switching signal was stored. With the double solenoid valve, the signal is stored in the valve. If, however, a spring-re-turn 4/2-way solenoid valve is used and the switching signal is given via a push-button, the signal must be stored in the signal control section. If the clamping device is to open again, a second push-button is pressed which deletes the stored data.

Using the clamping device from the preceding exercise, it is not possible to adjust the clamping pressure to different values without altering the system pressure. A reduction in system pressure can, however, mean that other consumers in the system – e.g. machining stations – no longer operate reliably. To adjust the clamping pressure to a level lower than the system pressure, a pressure regulator is installed upstream of the clamping device.

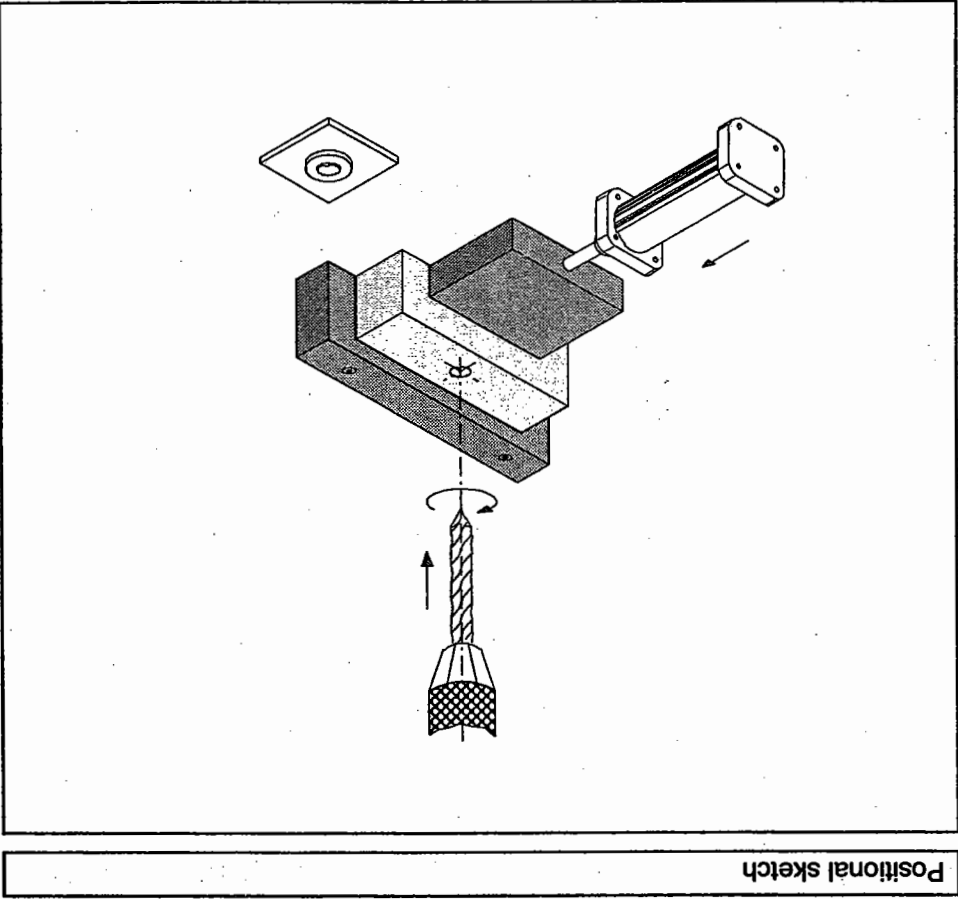

Positional sketch

Signal storage in the electrical section

- The valve is open in normal position.
 - The control pressure (port B) acts via the control line to the valve piston.
 - If the force generated at the valve piston exceeds the set spring force, the valve starts to close. The pressure at port B decreases to the set value, whilst the system pressure at port A is unaffected.
- Using a 2-way pressure regulator, the supply pressure is reduced to a lower adjustable initial pressure.

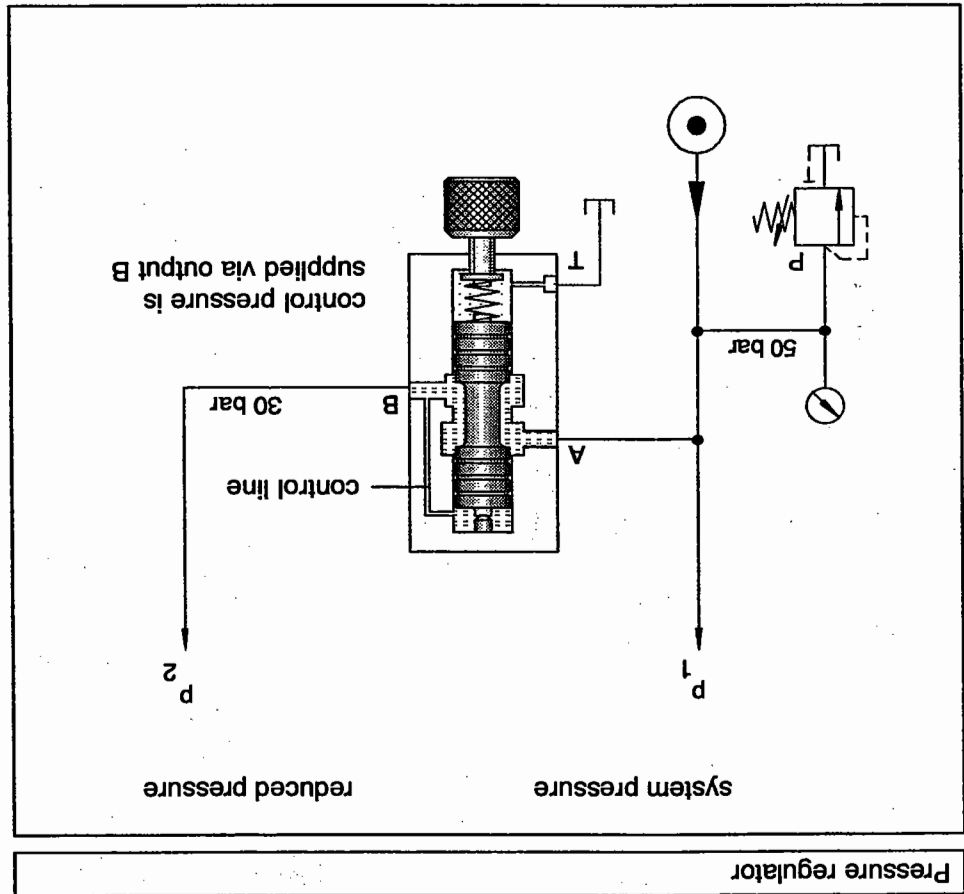

Hydraulic control
 Pressure regulators are used if different pressures are required in a system.
 Pressure regulator

Conclusions

Latching

If a relay or a contactor is activated via a push-button, the coil receives current and the contacts are switched. When the push-button is released, the contacts immediately switch back to their initial position.

If the contacts are to be prevented from switching back when the push-button is released, the relay coil must be supplied with current until another signal interrupts the power supply. This condition is realised via the latching circuit (signal storage).

Electrical latching, dominant setting

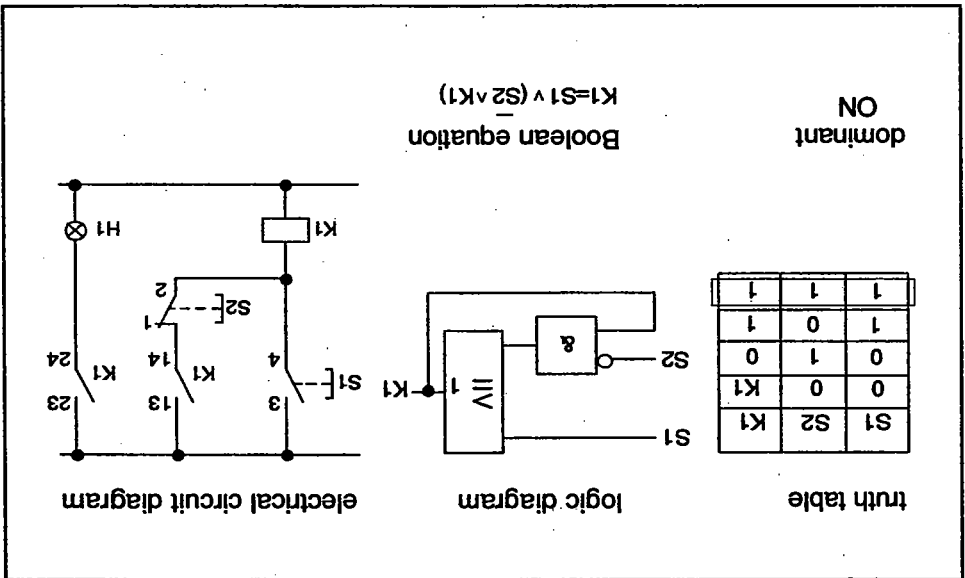

If the ON push-button S1 is pressed, current flows to the relay coil. The contacts switch over and contact K1 closes. If push-button S1 is released, the relay coil is supplied with current via contact K1 and reverts to latching. The input signal is therefore stored. If push-button S2 is pressed, the flow of current to the coil is interrupted, and contacts K1 open. If push-button S2 is released once again, the relay remains without current. If, therefore, neither of the two push-buttons is pressed, the previous switching status of the relay is retained, depending on contact K1.

If both push-buttons are pressed simultaneously in this circuit, coil K1 and its contacts are switched ($K1 = 1$). This circuit is therefore termed **dominant setting**.

For safety reasons, circuits with the condition **dominant resetting** are used for clamping devices. This condition is fulfilled if the relay contacts are not switched when both push-buttons are pressed ($K1 = 0$).

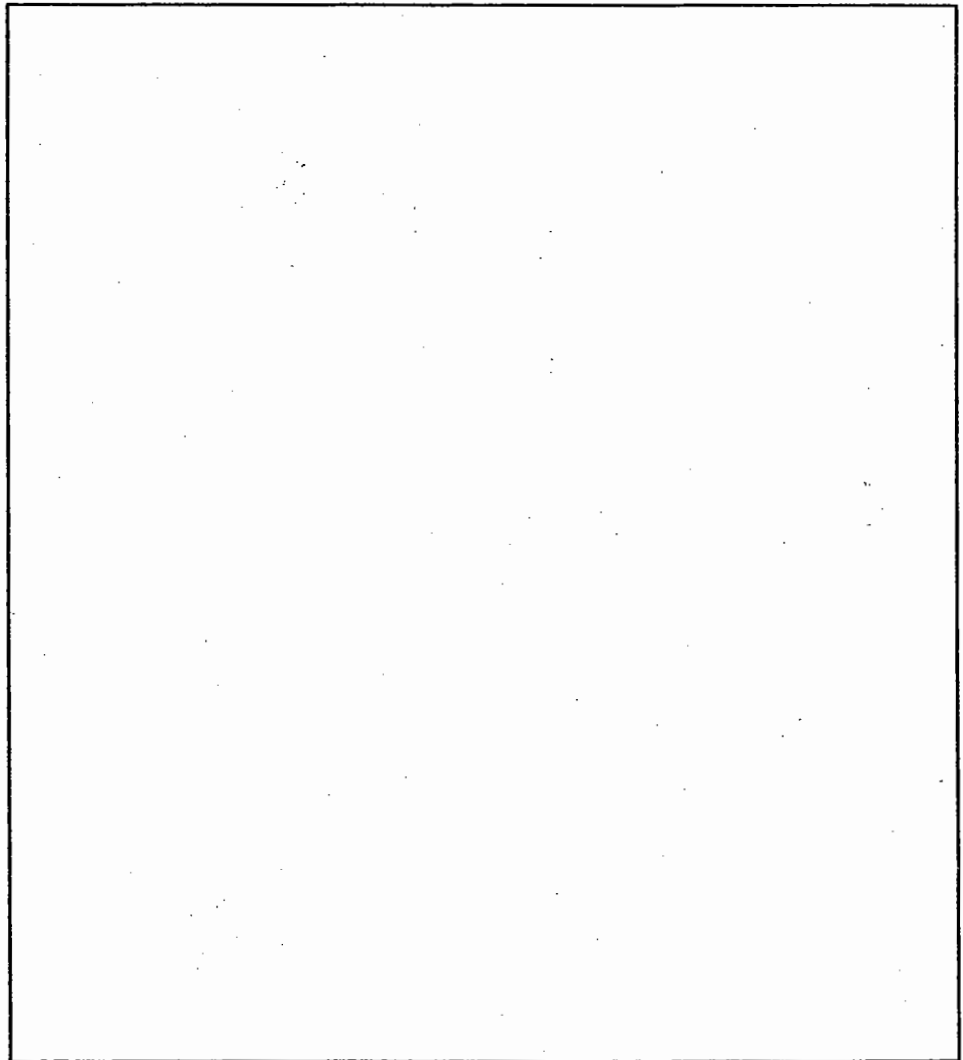

Hydraulic circuit diagram

Draw the hydraulic circuit diagram. Stipulate the point at which the pressure regulator is to be installed and give reasons for your decision.

1st step
Carrying out the exercise

2nd step

3rd step

Draw the electrical circuit diagram for actuation of the hydraulic system by developing a latching circuit with "dominant resetting" characteristics.

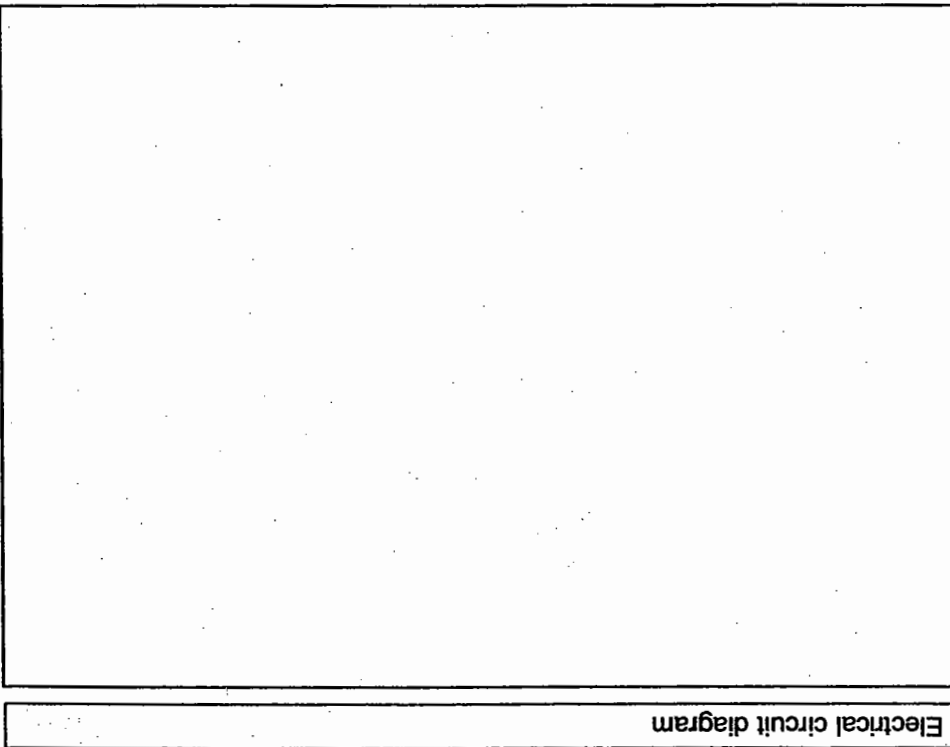

Draw the logic diagram for this circuit.

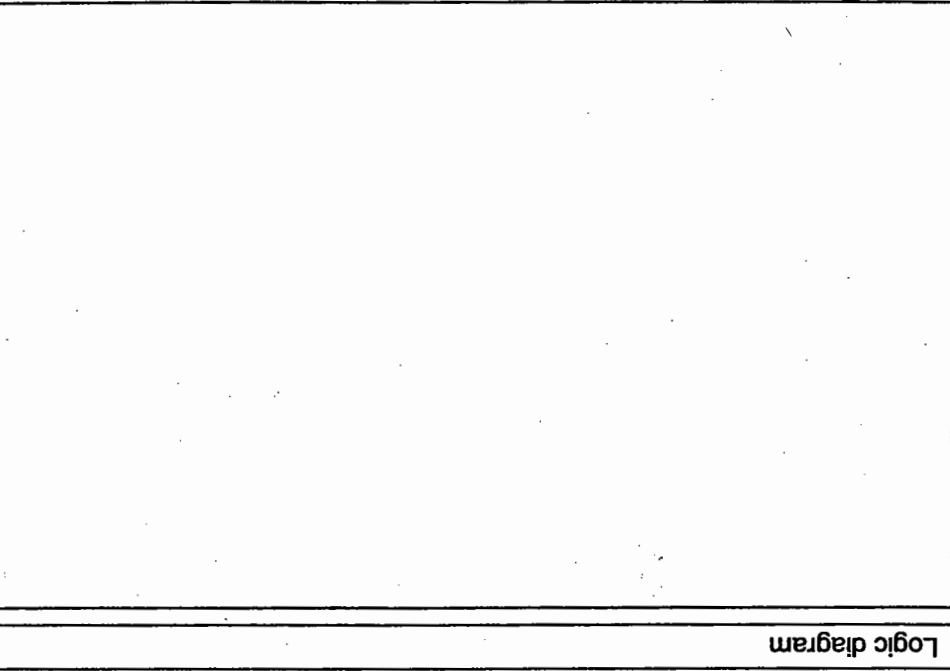

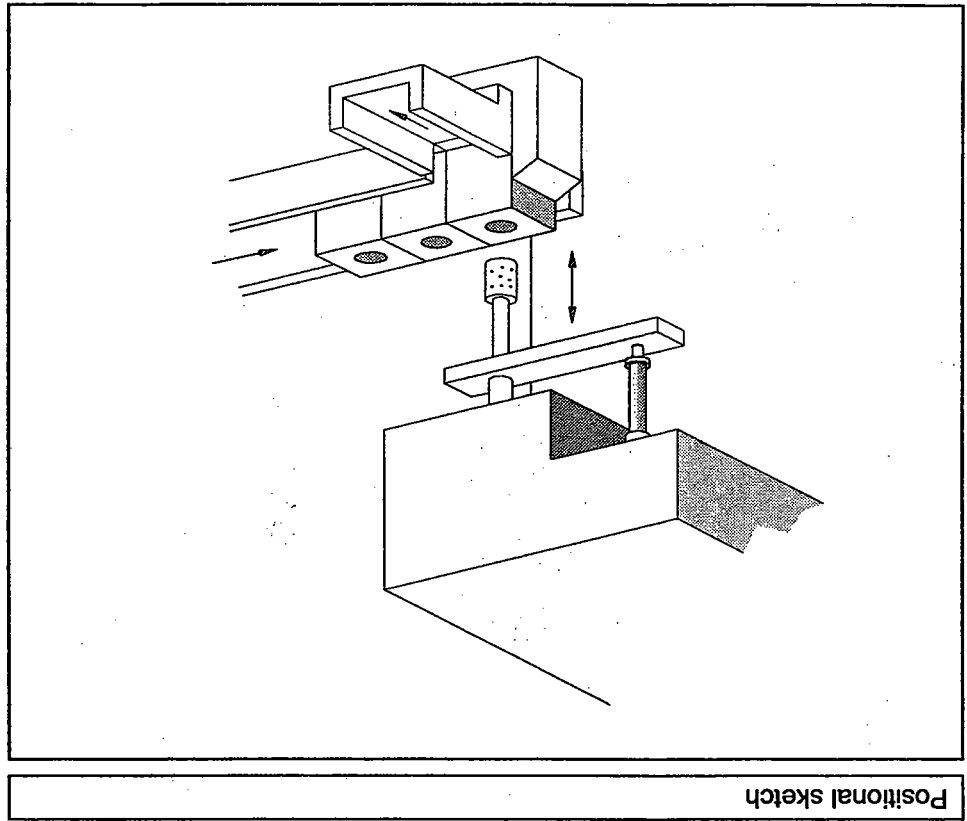

Positional sketch

Pre-drilled workpieces are finished using a reaming machine. The feed motion is performed by a double-acting cylinder. The advance and return stroke are to be effected at the same speed. Moreover, the speed should be adjustable. It must also always be kept exactly constant regardless of the load. The return stroke should be effected after a limit switch has been reached. A 4/2-way solenoid valve with spring return is to be used for actuation of the cylinder.

Flow control

This book only deals with throttle control using flow valves.

- a far more favourable solution from the point of view of power consumption is control of the flow rate via a control pump which generates the flow rate required. This type of control is known as displacement control. One disadvantage of this method is the inferior dynamic performance.
- with throttle control, the flow rate is regulated via valves, for example via flow control valves. If the constant flow rate delivered by the pump exceeds the required flow rate, part of the pressure fluid flows back into the tank via a pressure relief valve. This results in considerable power loss.

Throttle control

7.3 Speed control

Problem definition

Exercise 10

Conclusions

Cylinder with single-ended piston rod

Cylinder with through-rod (Synchronous cylinder)

Hydraulic control

In a double-acting cylinder with single-ended piston rod, the surface area on the piston side is greater than that of the piston rod side. With a constant pump delivery rate, therefore, the piston rod retracts faster than it advances.

The following illustration shows a double-acting cylinder with two piston rods of the same diameter. With this cylinder design, the two piston surfaces are the same size. The advance and return stroke speeds are therefore also identical. This cylinder is called a synchronous cylinder.

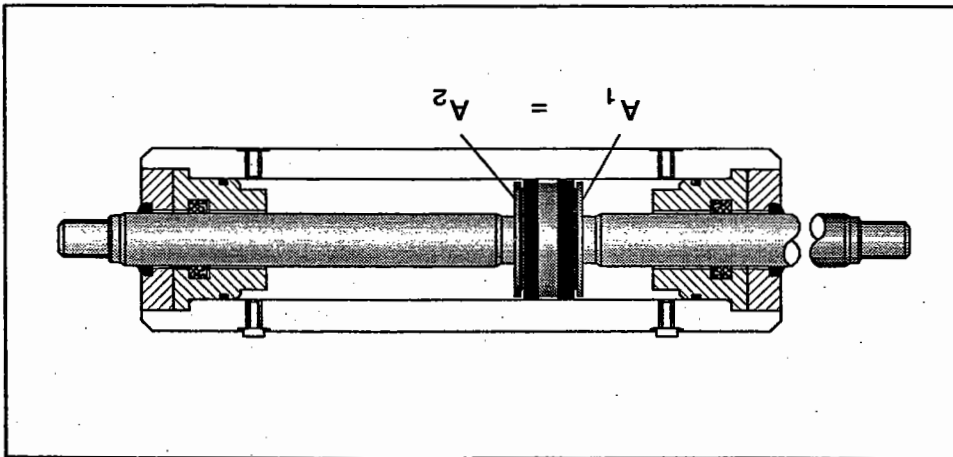

Synchronous cylinder

Differential circuit

If, due to lack of space, only a cylinder with one piston rod can be used, a differential or bypass circuit should be used.

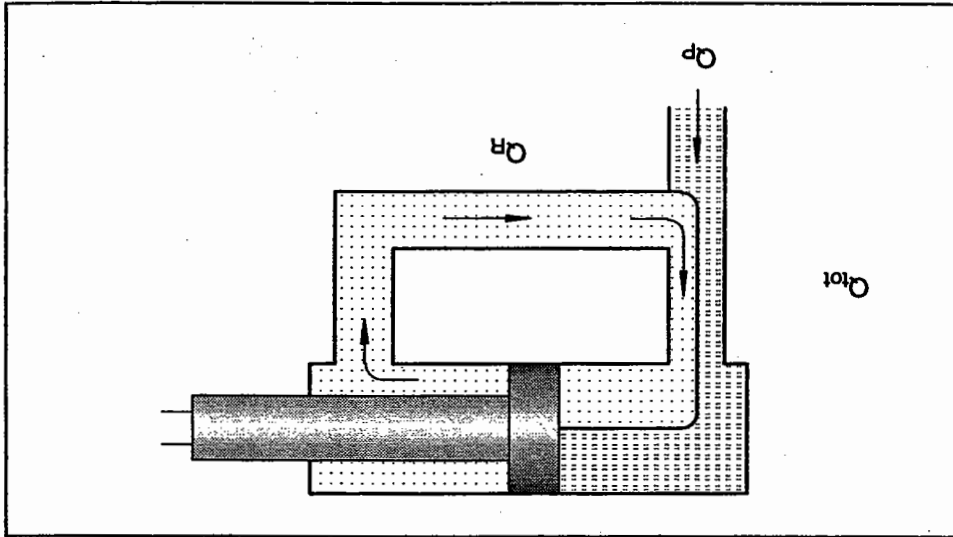

Bypass or differential circuit

The action of flow control valves is load-dependent; in other words, the traversing speed changes with changes in the force acting on the piston rod. Flow regulators operate on an almost load-independent basis. This means that the traversing speed of the piston rod remains constant even if the force acting on the piston rod changes.

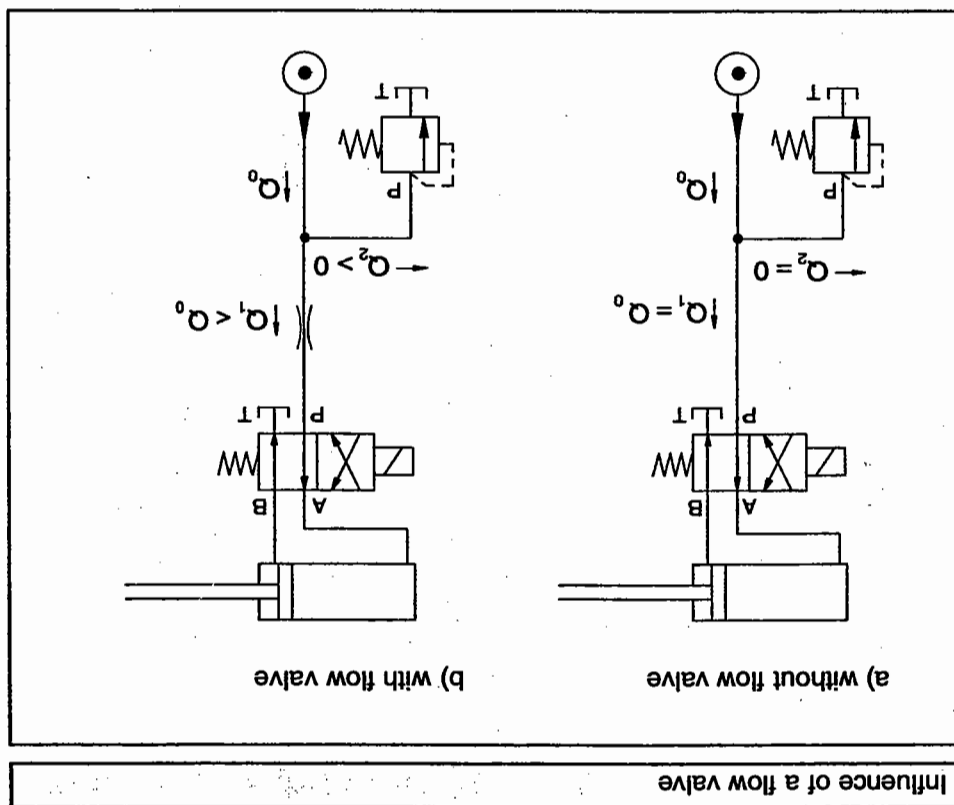

Flow valves are used to reduce the flow rate to the drive component. Due to its relatively small orifice cross-section, the flow valve has a high flow resistance. This results in a high pressure drop via the flow valve and thus also a high pressure level in the hydraulic circuit. The pressure relief valve opens and the constant flow rate of the pump (Q_0) is divided into two branches. As a result, the partial flow Q_1 flows to the drive component.

This circuit increases the advance stroke speed of the piston rod. If, as required in this exercise, the advance and return strokes are to be performed at the same speed, the surface ratio of piston surface to piston rod surface must be 2:1.

Speed control using flow valves

A 2.4

Counter-pressure valve

In this exercise the feed cylinder is arranged in such a way that the piston rod advances vertically. Due to the hanging weight of the reaming tool, a tensile load acts on the piston rod. The tensile load can generate a (partial) vacuum in the upper chamber. Uniform feed is then no longer possible and the piston rod is pulled jerkily out of the cylinder. To prevent this, a pressure relief valve is installed in the return flow line and adjusted in line with this load. A pressure relief valve installed in this manner is called a counter-pressure valve.

Electrical control

Limit switch

A mechanically actuated limit switch is required as a further electrical signal input element. Limit switches are actuated by a cam or a guide plate. They are mainly used to ascertain the position of cylinder pistons. Limit switches can be used, for example, to ascertain when an end position or any other desired position has been reached. Limit switches can be connected as normally closed contacts, normally open contacts or changeover contacts.

The following should be noted for this problem definition.

- The piston rod should advance if the ON push-button is pressed and the piston is in the retracted end position. To this end, a limit switch is used to monitor the retracted end position. The position of the limit switch is incorporated into the current path of the ON push-button as a start condition.
- After having reached the forward end position, the piston rod should immediately drive back into the starting position. For control of this motion, a further limit switch is used to monitor the forward end position.

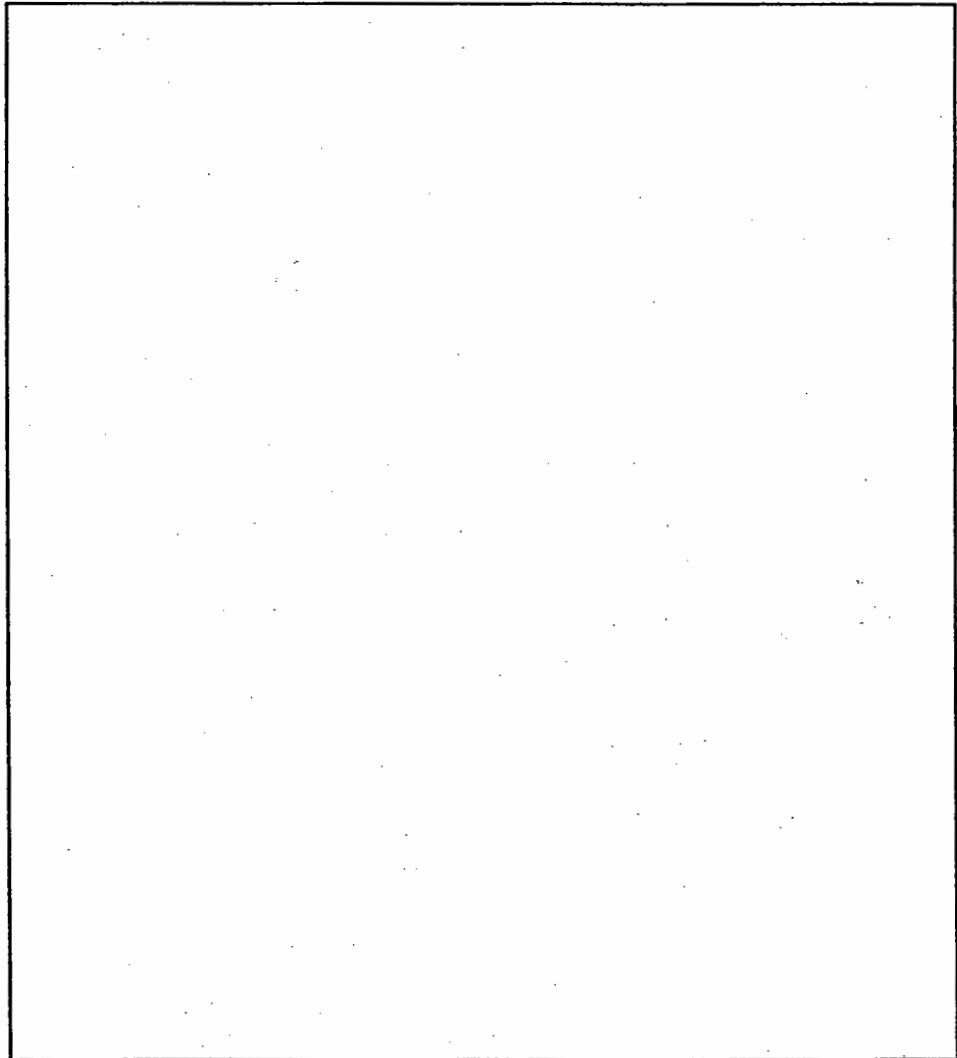

Hydraulic circuit diagram

Draw the hydraulic circuit diagram with a synchronous cylinder, taking into account the conditions laid out in the conclusions. Note that no flow can take place against the counter-pressure valve (pressure relief valve). The position of the limit switch (S1 retracted end position, S2 forward end position) is indicated by a vertical line in the circuit diagram (!).

Carrying out the exercise
1st step

2nd step

Draw the electrical circuit diagram with the starting condition that the retracted end position of the piston rod is monitored and the start button is not pressed.

Electrical circuit diagram

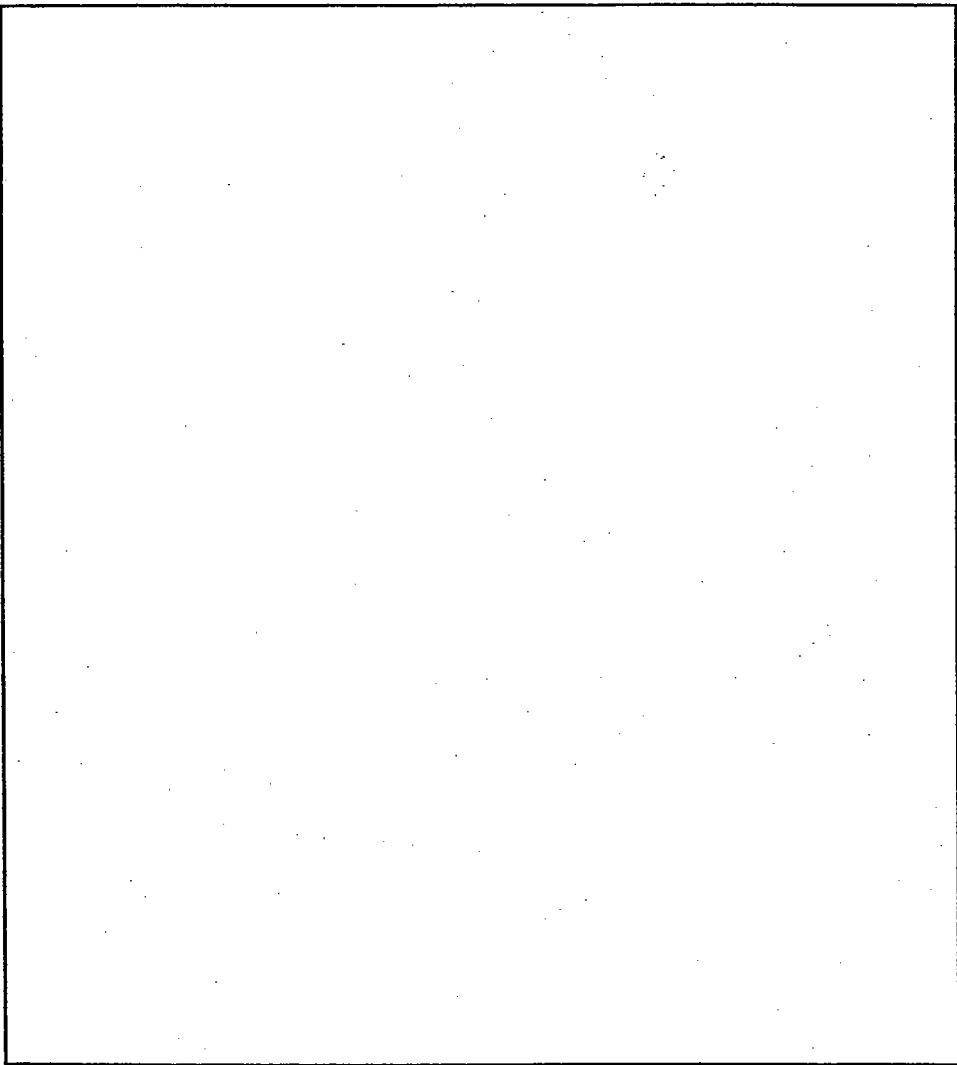

Sequence control system

Chapter 8





8.1 Exercise 11

Problem definition

Hardened bearing rings are pressed into grey cast iron blocks using a hydraulic press.

- As starting conditions, the master switch must be switched on and the retracted end position of the piston rod monitored via a limit switch. Pressing must take place at low, adjustable speed.
- If pressing is performed correctly, the return stroke is effected when a limit switch is reached. The return stroke should be unthrottled.
- If the maximum admissible pressing force is exceeded (e.g. if a ring is bent), the piston rod must retract and an optical signal must be given for safety reasons. The cylinder cannot recommence its operating cycle until an acknowledgement button has been pressed.

A sequence control system is a control with forced step-by-step sequence. Switching to the next step is achieved in the following exercises through position monitoring using limit switches.

Pressure- and path-dependent sequence control

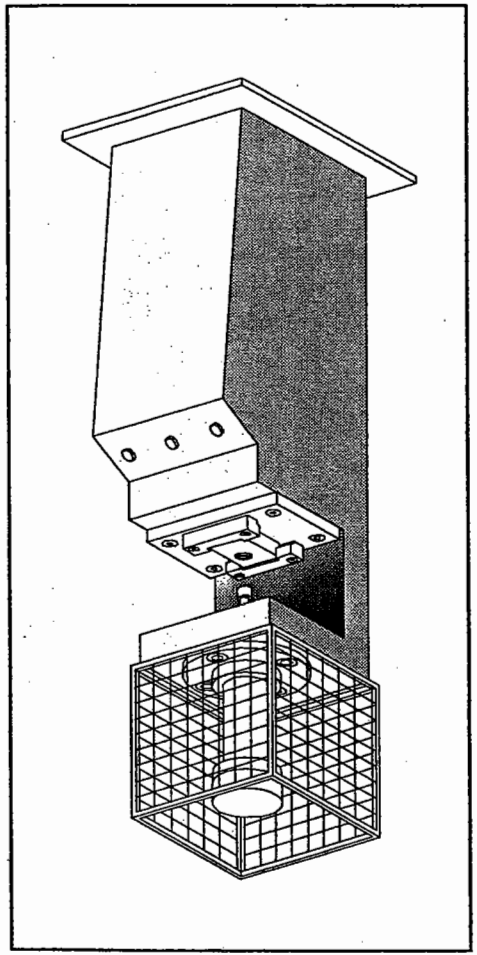

Positional sketch

Presses may not be operated without two-hand control or press safety control block. However, these safety devices are not dealt with here.

Safety note

Hydraulic control

Conclusions

This exercise does not require precise feed control. The use of a flow control valve (e.g. a throttle valve) is sufficient to reduce the speed. A flow regulator is not required. Throttle valves can be installed at the inflow or the outflow of the cylinder. If the valve is installed at the outflow (outflow throttling), a counter-pressure valve is no longer required. In this circuit, the piston rod should advance slowly and return quickly. It is for this reason that a one-way flow control valve is used.

Example: outflow throttling

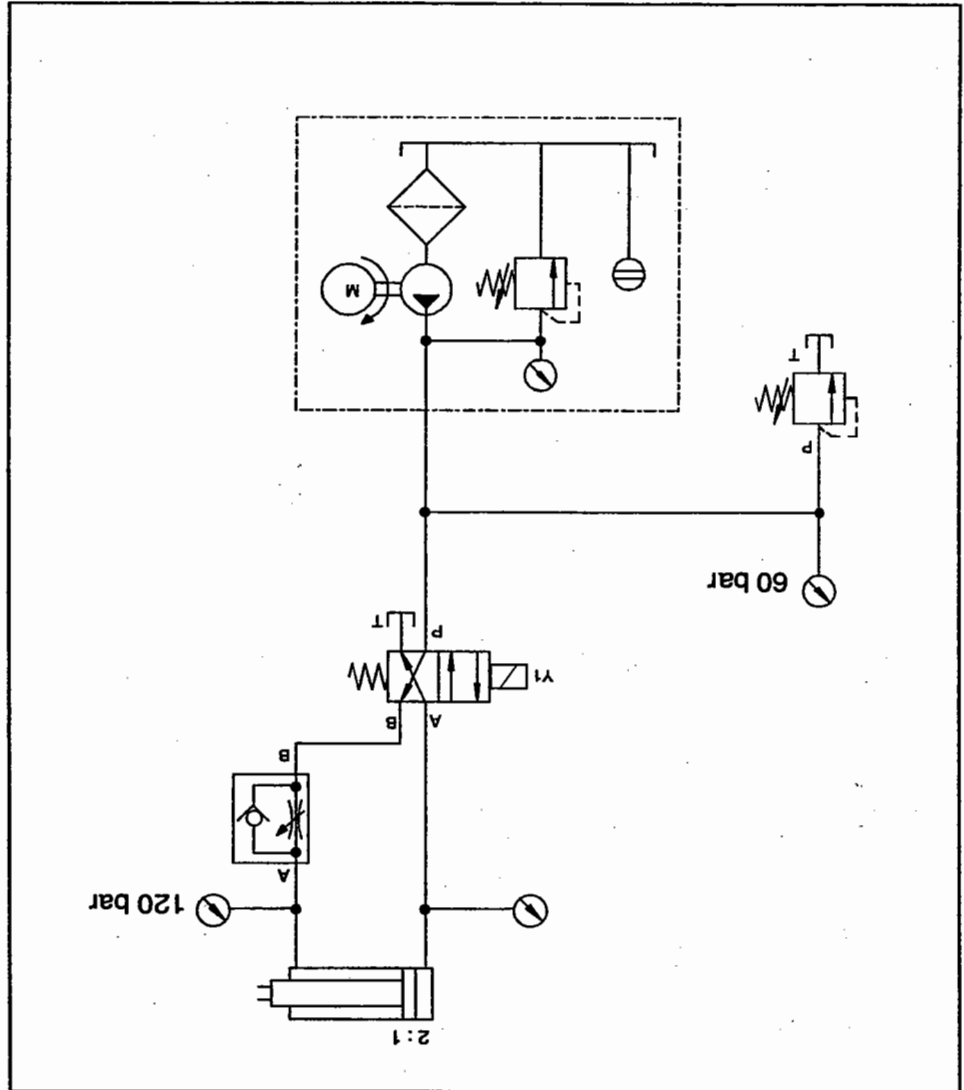

Pressure switch

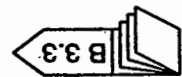

Carrying out the exercise
1st step

To ensure that outflow throttling results in flow separation and therefore in a reduction in speed, the throttle must be closed far enough to ensure that the system pressure relief valve opens. In the present example, the pressure at the system pressure relief valve is 60 bar. Due to the pressure transmission, the pressure in front of the one-way flow control valve is increased in the ratio of the piston surface to the piston rod surface. With a surface ratio of 2:1, the pressure in front of the throttle is approx. 120 bar (not taking into account the cylinder friction and the load). The cylinder, the pipes and the one-way flow control valve in this circuit must be designed to withstand a pressure of 120 bar, even if the supply pressure is only 60 bar.

Electrical control

Pressure switches switch electrical contacts when a set pressure is reached. A pressure switch can be connected as a normally closed contact, a normally open contact or a changeover contact. The switching point is set by prestressing a spring.

Complete the function diagram. Pay attention to the starting conditions listed in the problem definition. Designate the limit switch which monitors the retracted end position as S1, the switch for the forward end position as S2.

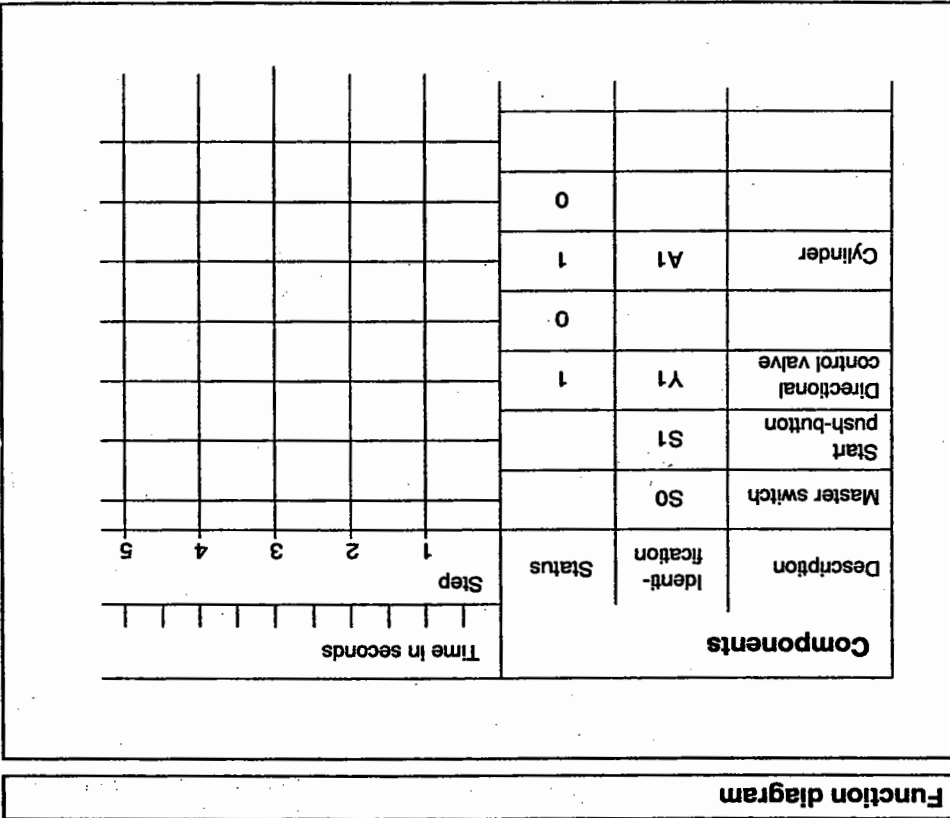

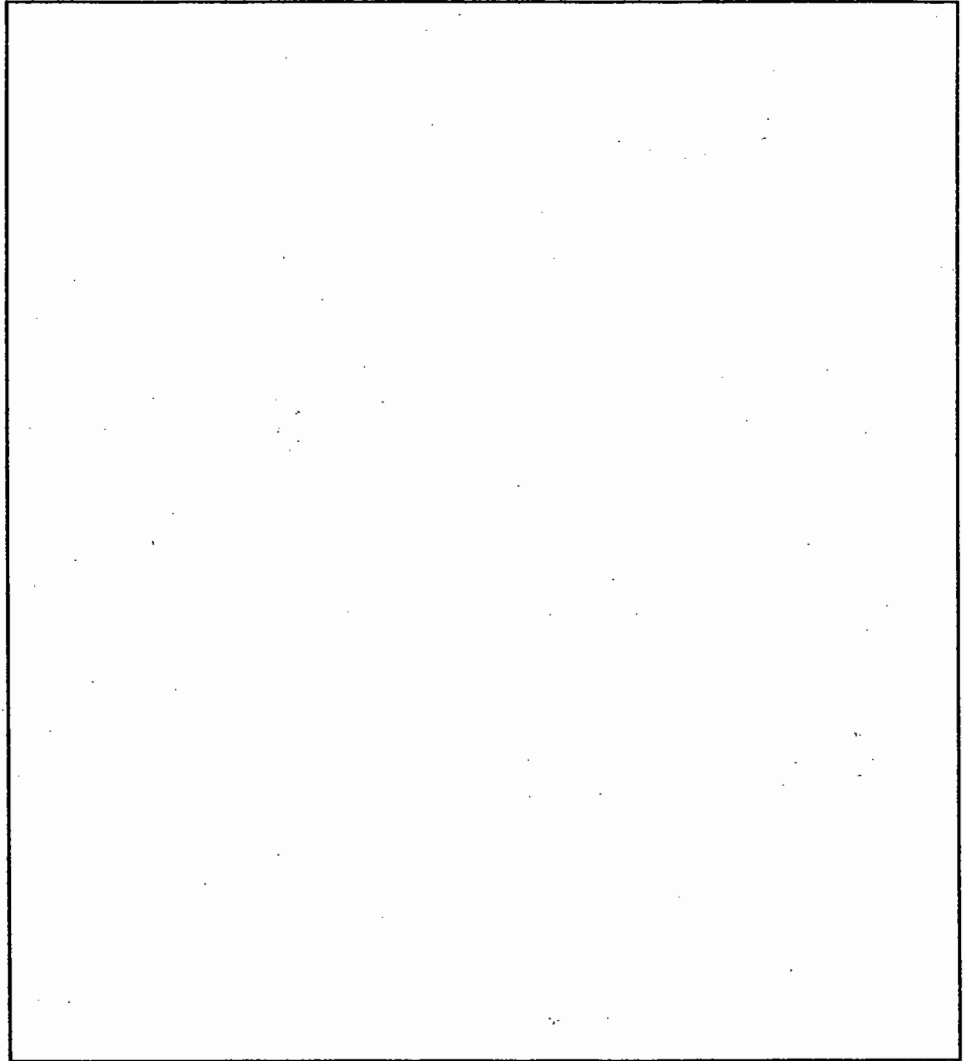

Hydraulic circuit diagram

- Use a spring return 4/2-way solenoid valve for actuation of the cylinder.
- Speed reduction should not be effected via an outflow throttle but via an inflow throttle.
- Note also that the weight of the press ram acts as a tensile load on the piston rod.
- The position of the limit switch is indicated in the circuit diagram by a vertical line (|).

Draw the hydraulic circuit diagram.

2nd step

3rd step

4th step

5th step

6th step

What maximum pressure occurs in the system with inflow throttling? Compare this pressure with the maximum pressure in the case of outflow throttling.

A differential cylinder with a piston diameter of 50 mm and a surface ratio of 2:1 should be used. The maximum admissible pressing force is 6000 N. To what bar value must the pressure switch be set if a pressure of 20 bar is created in the piston rod chamber due to the counter-pressure?

Note: the friction of the piston and piston rod gasket can be ignored.

Draw the electrical circuit diagram.

Electrical circuit diagram

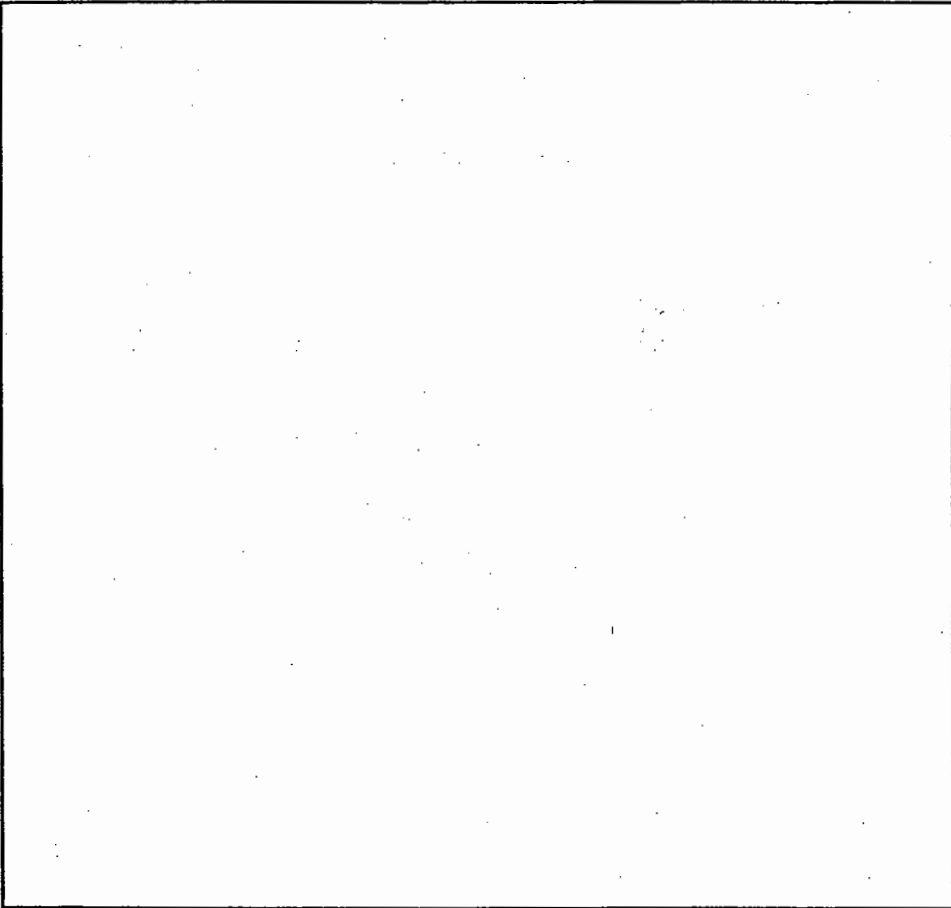

Explain the mode of operation of the electro-hydraulic system.

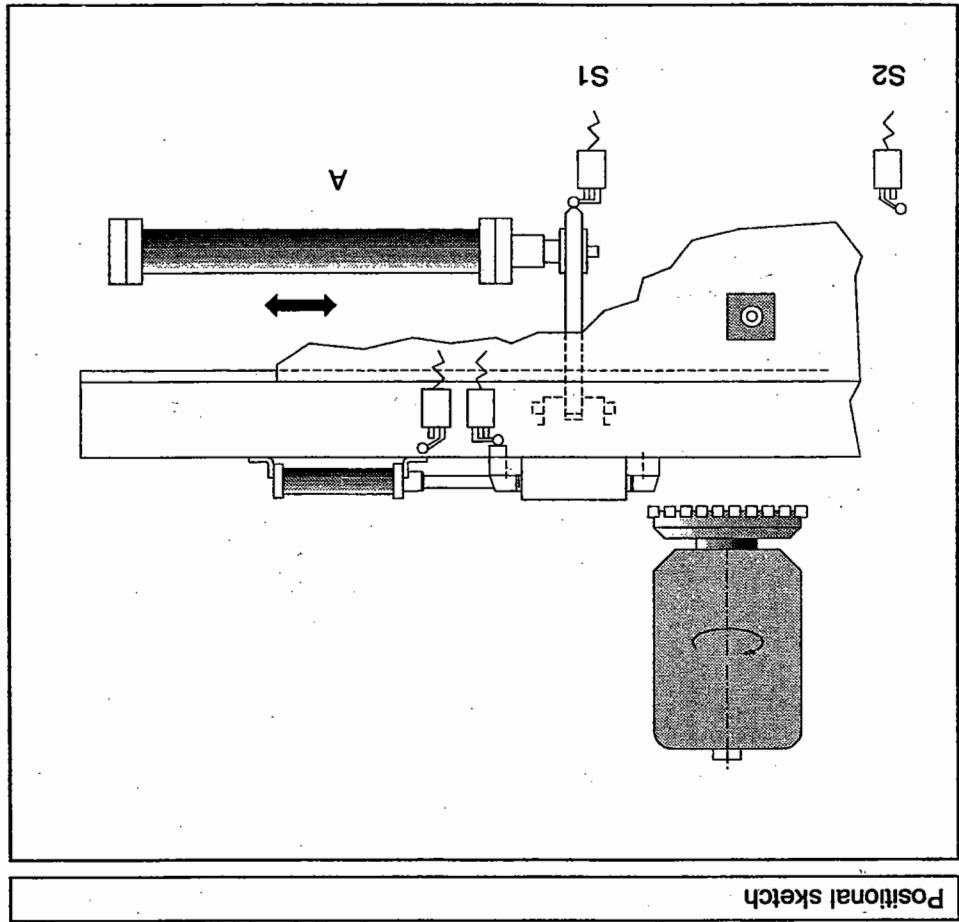

- A hydraulic cylinder (A) with a piston rod coupled to the milling table performs the working motion.
- The cylinder is activated by a 4/3-way solenoid valve with closed mid-position (spring-centred). If the valve is switched to mid-position during the advance or return movement of the milling table, the table stops even if the end stop has not been reached.
- The milling table should advance at an adjustable feed speed and return automatically in rapid motion after a limit switch (S2) has been reached.
- The control can be switched off by actuating a switch (normally closed contact). The 4/3-way valve then switches to the mid-position and the piston rod stops moving.
- If the milling machine is to be restarted after the control is switched off, the piston rod must first be driven into the starting position (S1). To achieve this, the piston rod must be brought into the end position manually, i.e. by holding down a push-button.

Clamped workpieces are surface-milled on a milling machine.

Problem definition

Sequence control with automatic operation

8.2 Exercise 12

Conclusions

Hydraulic control

In the no-load condition, the 4/3-way solenoid valve switches to the mid-position. In this mid-position all ports are blocked. This valve possesses no storage capability.

4/3-way solenoid valve

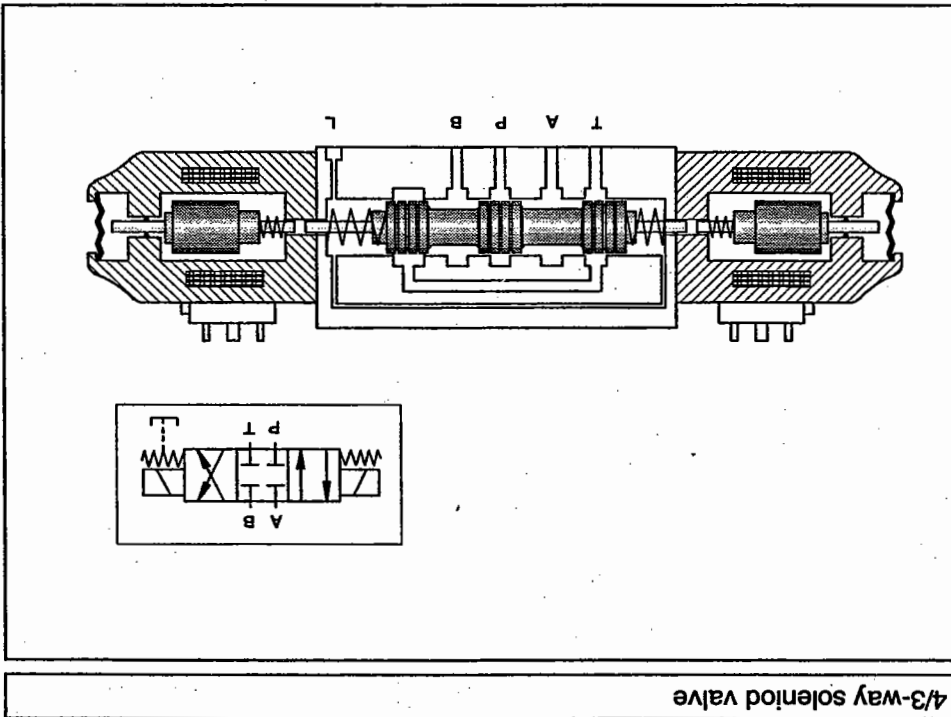

Electrical control

Manual operation

As the valve does not store the switching position, a latching circuit with relay must be installed in the electrical section of the control. If the latching function is switched off during the advance or return stroke, the piston rod stops in its momentary position (EMERGENCY stop). In this event, the piston rod can no longer be actuated, as the condition "Limit switch S1 actuated" is no longer fulfilled. It is therefore necessary to develop a circuit which can drive the piston rod back into its starting position after it has stopped. This return motion is activated via a push-button which – when held down – switches on the 4/3-way valve for the return stroke. However, this push-button must not take effect unless the switch "Automatic-Manual" was also pressed beforehand (interlock). This interlock function can also be effected electrically via a push-button and a further relay.

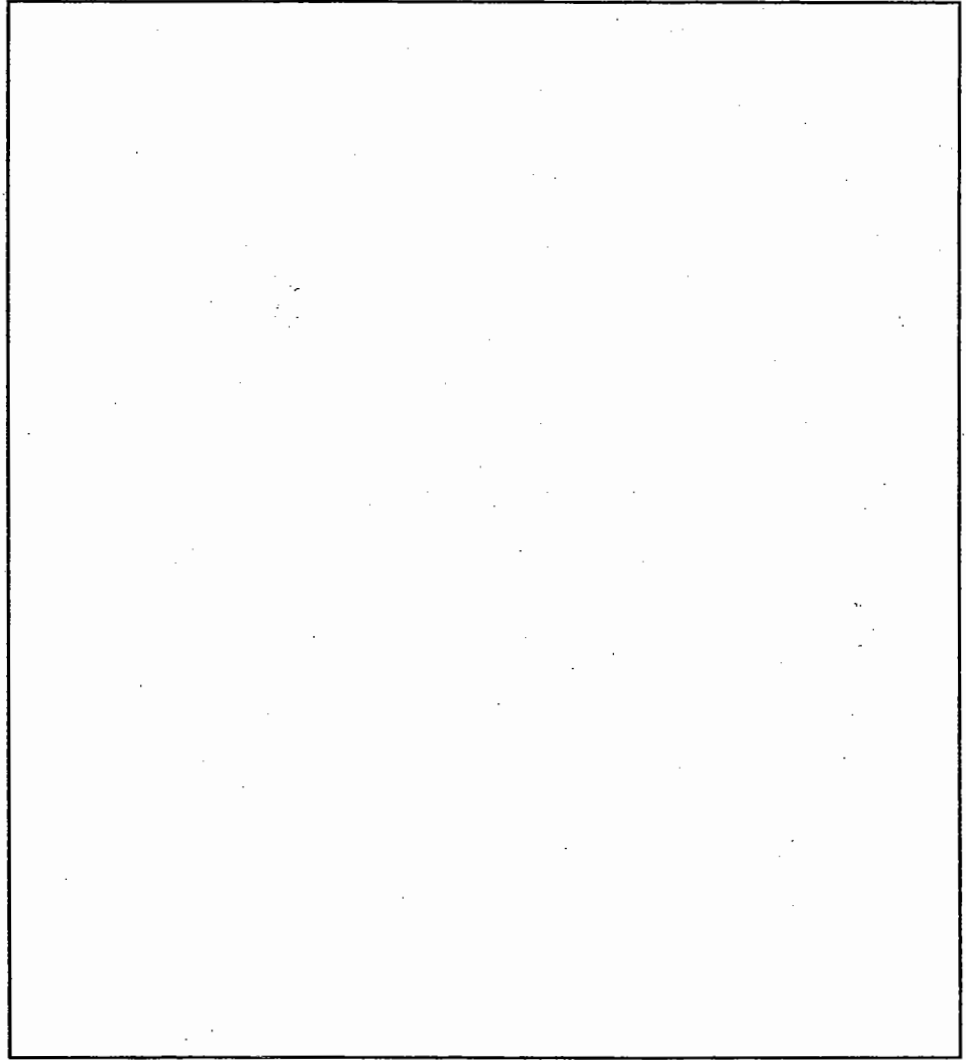

Hydraulic circuit diagram

- Note that tensile loads can also occur during milling.
- Note also that in the opposite direction the flow regulator only acts as a throttle, and that some designs do not allow any flow at all.

Draw the hydraulic circuit diagram.

Carrying out the exercise
1st step

2nd step

Draw the electrical circuit diagram. The switchover from automatic to manual operation should be effected via a control switch.

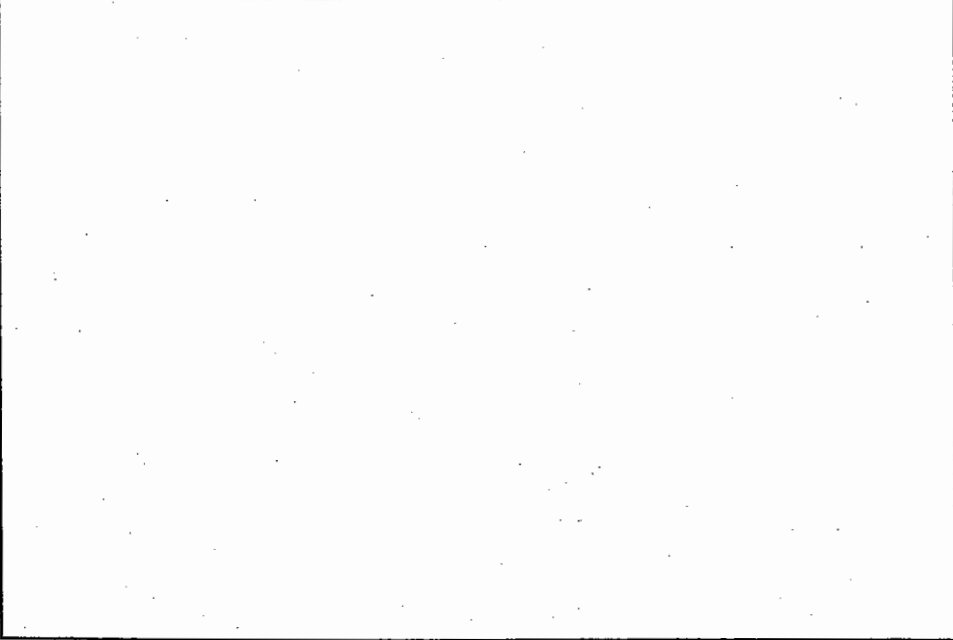

Electrical circuit diagram with control switch

3rd step

Draw the electrical circuit diagram. The switchover from automatic to manual operation should now be effected via a push-button and a relay.

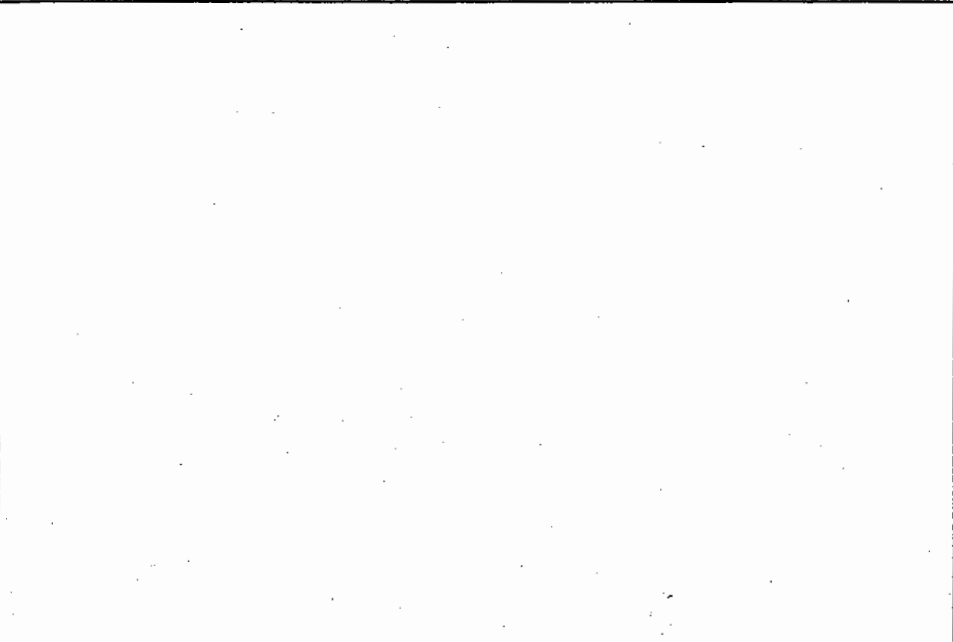

Electrical circuit diagram with push-button and relay

Fundamentals

Part B





Electro-hydraulic system

Chapter 1



1.1 Power section

An electro-hydraulic system mainly consists of the two function groups signal control section and power section.

The power section of an electro-hydraulic system comprises all the assemblies which ensure the power supply, the power control and the working movements of a system. In most cases, the power section hardly differs from the power section of a "purely" hydraulic system, with the exception of the actuation mode of the valves.

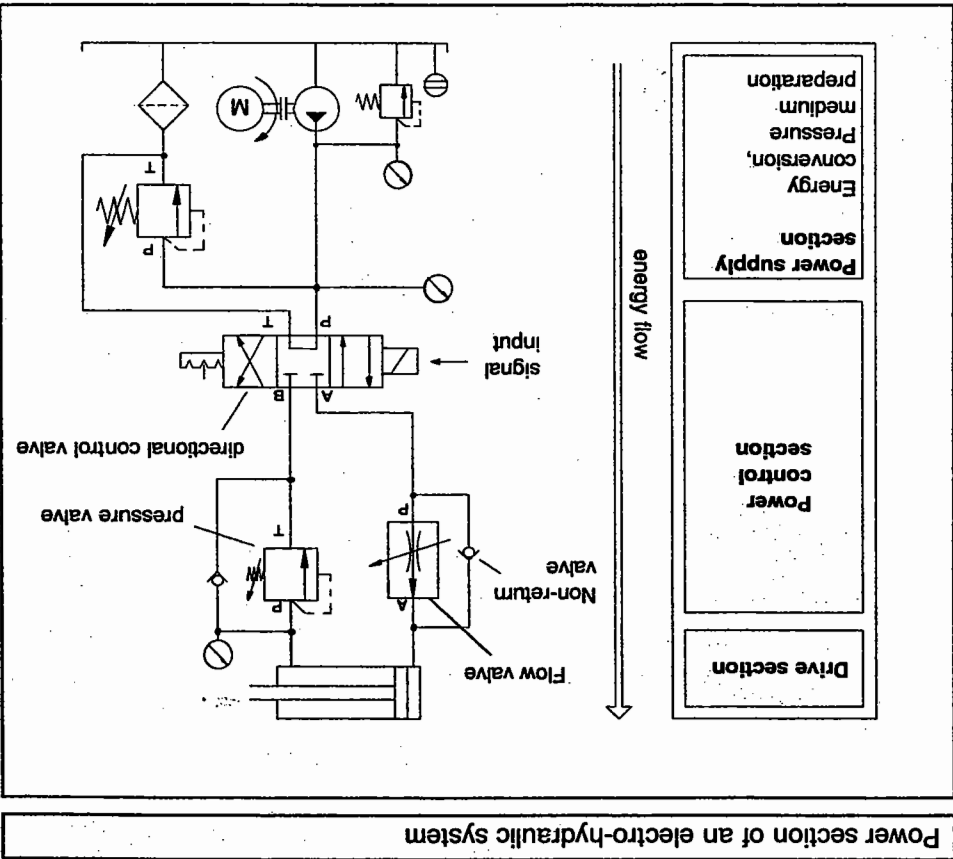

The power supply section is divided up into energy conversion and preparation of pressure medium. It is in this part of the system that the hydraulic energy is generated and the pressure fluid correctly prepared. In the energy conversion process – the electrical energy is converted first into hydraulic and then mechanical energy – the following components are normally used:

- electric motor or combustion motor
- coupling
- pump
- pressure gauge
- protective devices

Power supply section

The pressure medium is prepared using the following components:

- tank with fluid level indicator
- filter
- cooler
- heater
- temperature indicator

In electro-hydraulic systems, the task of power control is performed by valves. According to the tasks they perform within the system, these valves can be divided into four groups:

- directional control valves
- non-return valves
- pressure valves
- flow valves

Drive section

The working movements are performed in the drive section of the system. The hydraulic energy in the pressure medium is converted into mechanical energy with the help of cylinders or motors. The power consumption of the drive components in the drive section determines the requirements with regard to the design of the components in the power supply section and the power control section. All components must be designed for the pressures and flow rates occurring in the operating section.

1.2 Signal control section

The signal control section of an electro-hydraulic system differs considerably from the signal control section of a purely hydraulic system. In a hydraulic system, the corresponding functions are chiefly performed by operating staff. In electro-hydraulic systems, the signal control section is divided into two function areas: signal input (sensor technology) and signal processing (processor technology).

Signal input

With signal input, a general distinction should be made between signals given by the operator (via push-buttons, switches etc.) and signals transmitted within the system (limit switches, proximity switches, temperature sensors, special indicators, pressure switches etc.).

Signal processing

In electro-hydraulic systems, signal processing is effected either via electrical circuits or PLCs. There are also purely pneumatic and, the less popular, hydraulic circuit options for the processing of signals. In this book, signal processing is effected by electrical circuits (see exercises in Part A).

1.3 Interface

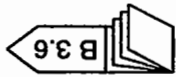

The valve solenoids form the interface between the signal control section and the power section of an electro-hydraulic system. DC magnets with an operating voltage of 24 V are generally used to actuate the solenoid valves. AC solenoids are also used in the voltage range from 110 V - 220 V.



Fundamentals of electrical engineering

Chapter 2



2.1 Direct current and alternating current

A simple electrical circuit consists of a voltage source, a consuming device and a connecting line (supply line and return line). In physical terms, what happens is that negative charge carriers – the electrons – travel via the electrical conductor from the negative terminal of the voltage source to the positive terminal. This movement of charge carriers is called electric current. It should be noted that an electric current can only flow in a closed conductor circuit.

A distinction is made between direct current and alternating current:

- if the voltage in a circuit always acts in the same direction, a current flows which also always has the same direction. We call this a direct current or DC circuit.
- in the case of alternating current or in an alternating current circuit, the direction of the voltage changes with a certain frequency. As a result, the current also changes its direction and strength continuously.

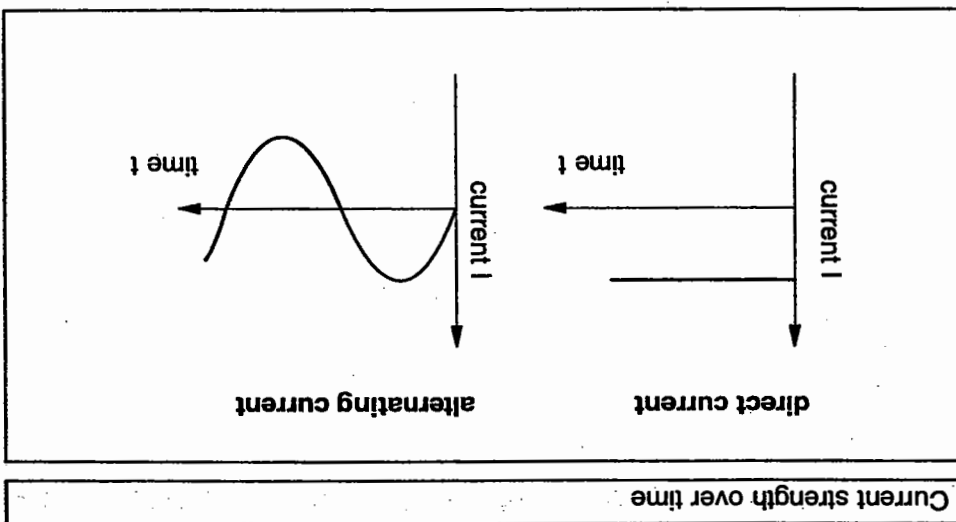

Every material puts up a certain level of resistance to electrical current. This resistance depends on, among other things, the atomic density and the number of free electrons. It is generated by the collision of the free mobile electrons with the atoms of the conductor material and the restriction of movement of the electrons caused by these collisions. In the field of control technology, copper is the most frequently used conductor material. The electrical resistance of copper is particularly low.

Electrical resistance

At the negative terminal of a voltage source there is an electron surplus, while at the positive terminal there is a shortage of electrons. This results in a difference in electron assignment between the two terminals. This condition is known as source voltage.

Source voltage

Electric current is the directional movement of charges. The charge carriers can be electrons or ions. But current can only flow if the material used possesses a sufficient number of mobile charge carriers; we then speak of an electrical conductor.

Electrical conductor

If the switch contact in the above circuit is closed, a current I flows via the consumer. The electrons travel from the negative terminal to the positive terminal of the voltage source. Before scientists became aware of the existence of electrons, the current direction was described as from "plus" to "minus". This definition is still valid today – it is termed the technical direction of current.

Technical direction of current

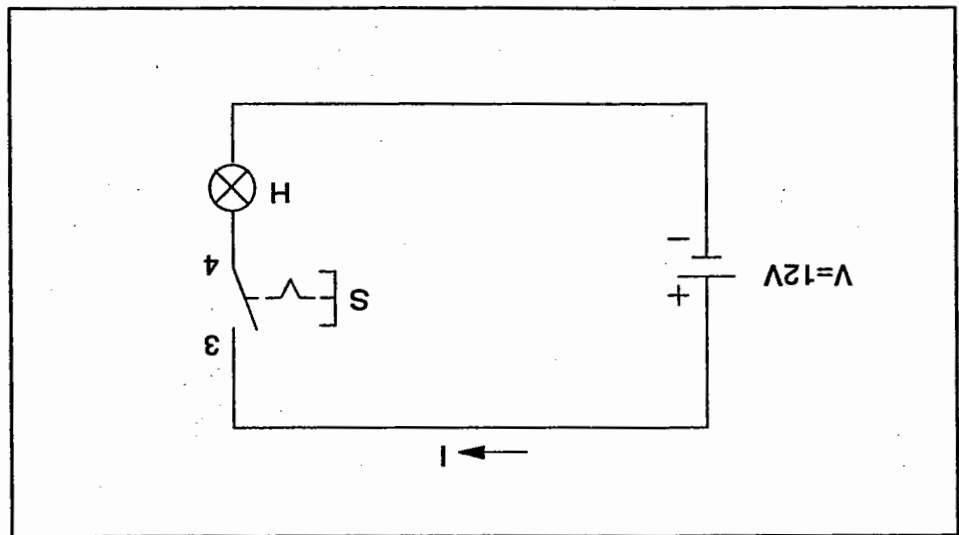

DC circuit

The following illustration shows a simple DC circuit consisting of a voltage source, electrical lines, a switch and a consumer (in this case a lamp).

2.2 DC circuit

Ohm's law

The relationship between voltage, current strength and resistance is described by Ohm's law. Ohm's law states that in a circuit with constant resistance the current strength changes in proportion to the change in voltage:

- if the voltage increases, the current strength also increases.
- if the voltage falls, the current strength also decreases.

Ohm's law

$V = R \cdot I$	$R =$ resistance; unit: ohm (Ω)	$I =$ current strength; unit: ampere (A)
	$V =$ voltage; unit: volt (V)	

Electrical power

In the field of mechanical engineering, power can be defined in terms of the work performed. The faster a task is performed, the greater the required power. Power therefore means work per unit of time.

In the case of a consuming device in a circuit, electrical energy is converted into kinetic energy (e.g. electrical motor), light radiation (e.g. electrical lamp) or thermal energy (e.g. electrical heater, electrical lamp). The faster the energy is converted, the greater the electrical power. In this case, therefore, power means converted energy per unit of time. It increases with increasing current and increasing voltage.

Electrical power

$P = V \cdot I$	$V =$ voltage; unit: volt (V)	$I =$ current strength; unit: ampere (A)
	$P =$ power; unit: watt (W)	

The electrical power of a consuming device is also called electrical power consumption.

Example: A solenoid coil is supplied with a direct voltage of 24 volts. The resistance of the coil is 19.9 Ω. How great is the electrical power consumption?
 calculation of the electrical power of a coil

First, the current strength is calculated:

$$I = \frac{R}{V} = \frac{24 \text{ V}}{19.9 \Omega} = 1.206 \text{ A}$$

This gives us the electrical power consumption:

$$P = V \cdot I = 24 \text{ V} \cdot 1.206 \text{ A} = 28.944 \text{ W}$$

Electrical controls are generally supplied with a direct current of 24 V. The alternating voltage from the power supply therefore has to be stepped down to 24 V and then rectified.

Rectification is performed by semiconductor diodes. They allow the current to flow in one direction and block it in the other. Their effect on electrical current can be compared to the effect of a non-return valve on the pressure fluid in a hydraulic system.

Diodes

Various diode circuit arrangements can be used for rectification. The most important circuit is the bridge or Graetz circuit. For the supply of current to electronic controls (PLCs) or if sensors are used, the direct voltage supplied by the rectifier must be smoothed using a charge capacitor and, if necessary, downstream filters (chokes or filter resistors).



Bridge rectifier circuit with charge capacitor

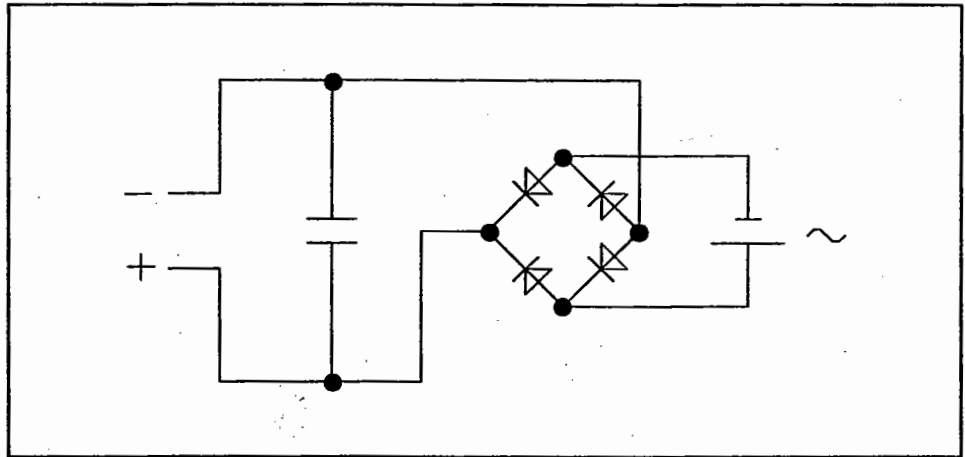

2.3 Electromagnetism

The solenoid coils, relays and contactors used in electro-hydraulics work on the principle of electromagnetism:

- every conductor through which current flows builds up a magnetic field around itself.
- the direction of current in the conductor determines the direction of the field lines.
- the current strength in the conductor influences the strength of the magnetic field.

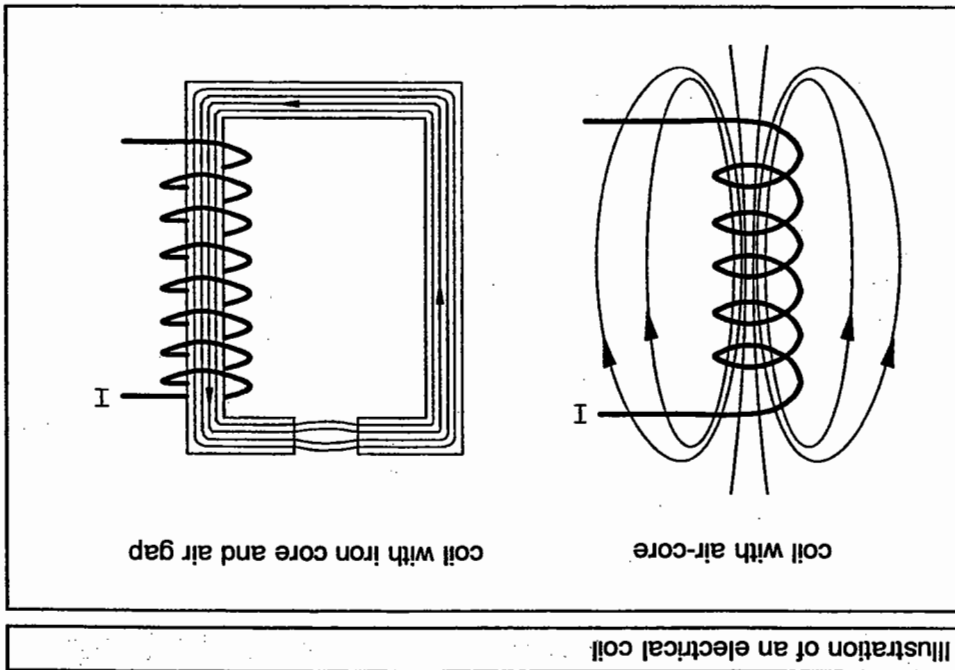

To increase the magnetic field, the conductor through which the current flows is wound in the form of a coil. If the field lines are then superimposed on the coil windings, the main direction of the magnetic field can be established. If the coil possesses an iron core, the iron is also magnetised. This makes it possible to generate considerably greater magnetic fields than can be achieved using an air-core coil with the same amount of current.

An electromagnet must meet two conflicting requirements:

- minimum current input (low energy consumption) and
- maximum power through a strong magnetic field.

To simultaneously meet both criteria, electromagnets are made up of a coil with iron core.

Electromagnet

$$1 \text{ F} = 1 \frac{\text{As}}{\text{V}}$$

The unit of capacitance is the "Farad" (F):

If a capacitor is connected to a direct voltage source, a charging current flows for a short time. The two plates are electrically charged in opposing mode. If the connection to the voltage source is then interrupted, the charge remains stored in the capacitor – until the charge is dissipated via a consuming device (e.g. a resistor).

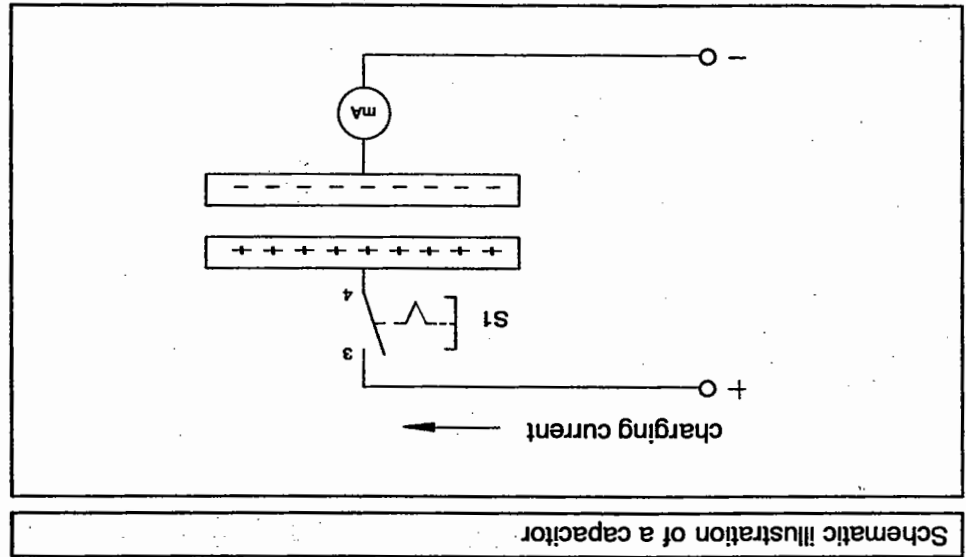

A capacitor consists of two metallic plates with an intermediate insulation layer (dielectric). The greater the capacitance of a capacitor, the more electrical charge carriers it stores at the same voltage.

2.4 Capacitance

$$1 \text{ H} = 1 \frac{\text{Vs}}{\text{A}} = 1 \Omega\text{s}$$

The unit of inductance is the "Henry" (H):

If an alternating voltage is applied to a coil, the current – and thus also the magnetic field – is constantly increased and decreased. The change in the magnetic field induces a current in the coil. The induced current counteracts the current generated by the magnetic field. The coil therefore puts up a resistance against the alternating current. This resistance is called inductive resistance. In the case of direct voltage, the voltage, the current and the magnetic field only change upon switch-on. In this case, therefore, the inductive resistance is only active at the time of switch-on.

Inductive resistance with alternating voltage

Inductive resistance with direct voltage

2.5 Measurements in a circuit

Rules for measuring

The term "measurement" means the comparison of an unknown quantity with a known quantity. Measuring instruments make it possible to perform this comparison with a greater or lesser degree of precision. The accuracy of a measurement depends on the precision of the measuring instrument.

When taking measurements in electrical circuits, the following rules should always be observed:

- never knock measuring instruments.
- carry out a zero point check prior to measurement.
- when measuring direct voltage or direct current, note the polarity of the measuring instrument (terminal "+" of the measuring instrument to positive terminal of the voltage supply).
- select the largest measuring range before switching on the voltage.
- observe the needle and gradually switch to smaller measuring ranges. Read off the value at maximum needle deflection.
- to avoid reading errors, always look at the needle vertically.

Example:
indicating error

The indicating error of a voltmeter of class 1.5 is to be investigated by measuring a battery voltage (approx. 9 V). The measuring range is adjusted once to 10 V and once to 100 V.

Measuring range	Permissible indicating error	Percentage error
10 V	$10 \text{ V} \cdot \frac{1.5}{100} = 0.15 \text{ V}$	$\frac{0.15 \text{ V}}{9 \text{ V}} \cdot 100 = 1.66 \%$
100 V	$100 \text{ V} \cdot \frac{1.5}{100} = 1.5 \text{ V}$	$\frac{1.5 \text{ V}}{9 \text{ V}} \cdot 100 = 16.6 \%$

The sample calculation shows clearly that the greater the deflection of the needle, the more precise the measurement. In other words: the measuring range selected on the measuring instrument should ensure that the indication is in the latter third of the measuring scale.

If current flows through a measuring instrument, there is a voltage drop via the measuring instrument. This affects all currents and voltages in the circuit. The resulting measurement is therefore falsified not only by the indicating error but also by the influence of the measuring instrument on the circuit.

To measure electrical voltage, a suitable measuring instrument must be connected parallel to the consuming device. To ensure that measuring inaccuracies are kept to a minimum, only an extremely small current may flow through the voltmeter. Otherwise, the current decreases due to the consuming device, as does the voltage drop, and the measured voltage is too small. For this reason, a voltmeter with a maximum possible resistance must be used. This resistance is also called the internal resistance of the voltmeter.

Voltage measurement

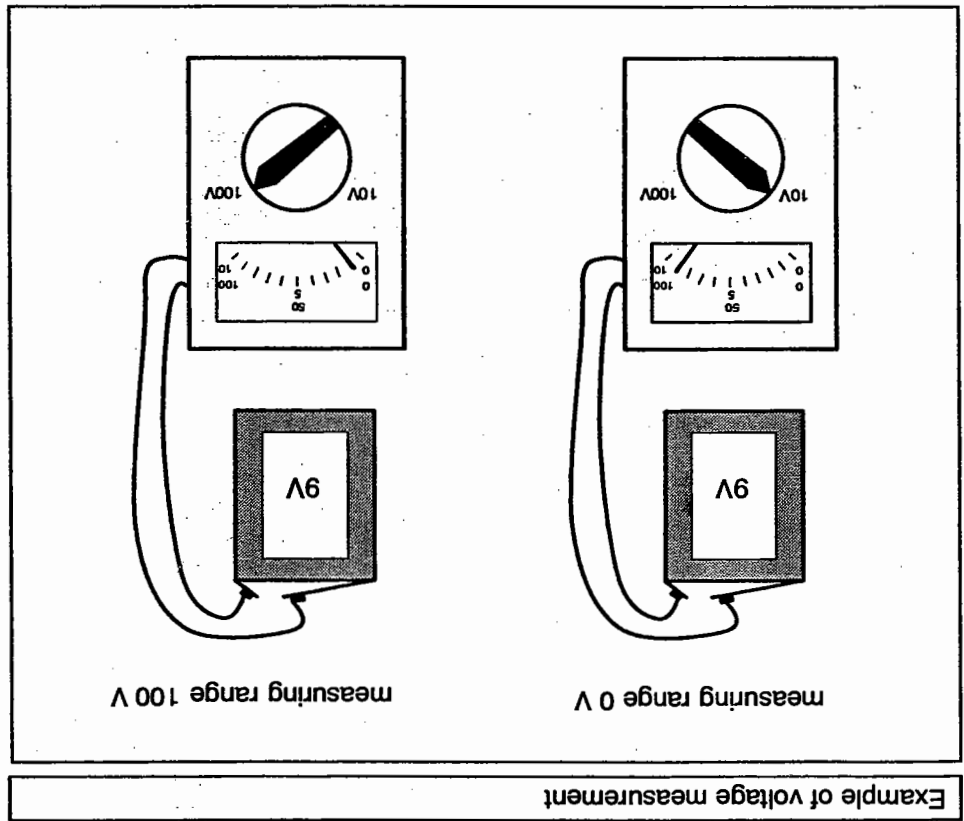

Current measurement

If the current in a circuit is to be measured, the entire current must be able to flow through the measuring instrument. For this purpose, the current measuring instrument (ammeter) is connected in series with the consuming device. Every current measuring instrument possesses a specific internal resistance. This additional resistance reduces the flow of current. The measured current is therefore smaller than the current which flows in the circuit when no measuring instrument is connected. To keep the measuring error as small as possible, only current measuring instruments with an extremely low internal resistance may be used.

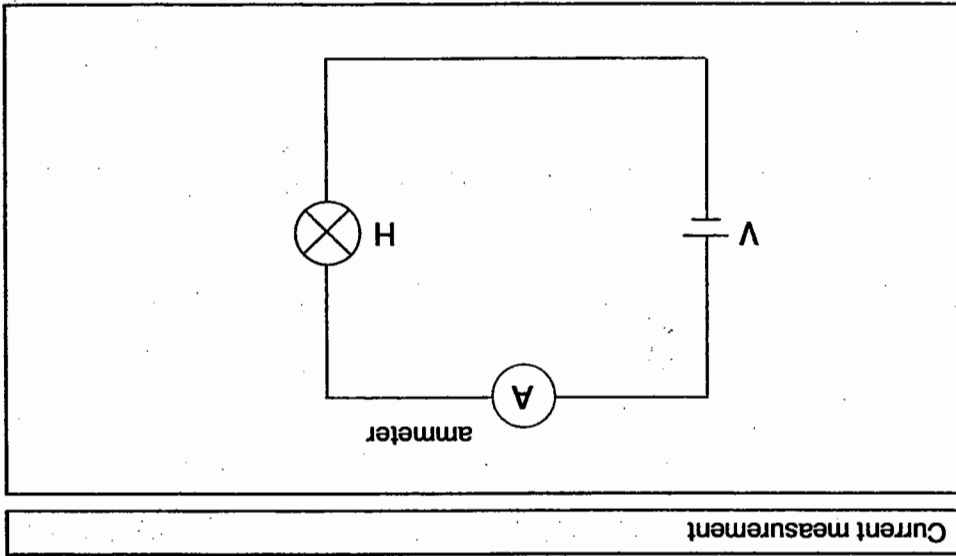

Electrical components

Chapter 3



3.1 Power supply unit

Safety note

The signal control section in electro-hydraulic systems is made up of electrical or electronic components. Depending on the task to be performed, the signal control section can vary in design:

- relatively simple controls use either electro-mechanical components with contacts (e.g. relays) or a combination of components with contacts and electronic components without contacts.
- for complex tasks, on the other hand, stored-program controls (PLC's) are mostly used.
- The circuit examples and explanations in this textbook are primarily based on electro-mechanical components, but also describe certain contactless components.

Electro-hydraulic control systems are generally supplied with electricity not from their own voltage sources (e.g. batteries) but from the mains supply via a power supply unit.

The components of the power supply unit form the power current system (DIN VDE 0100) in an electrical circuit. The safety regulations for power current systems must therefore, be observed!

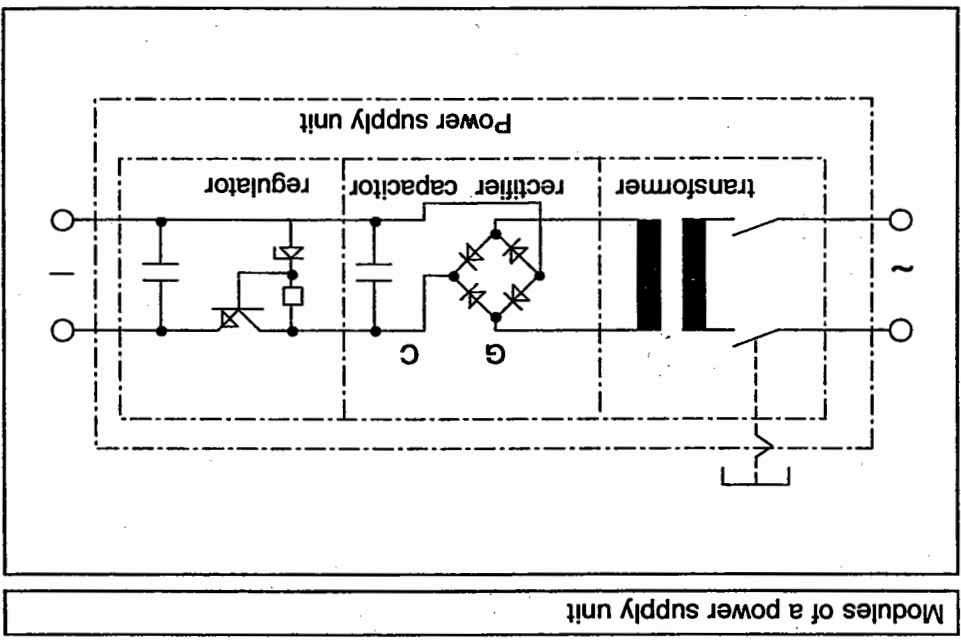

Modules of a power supply unit

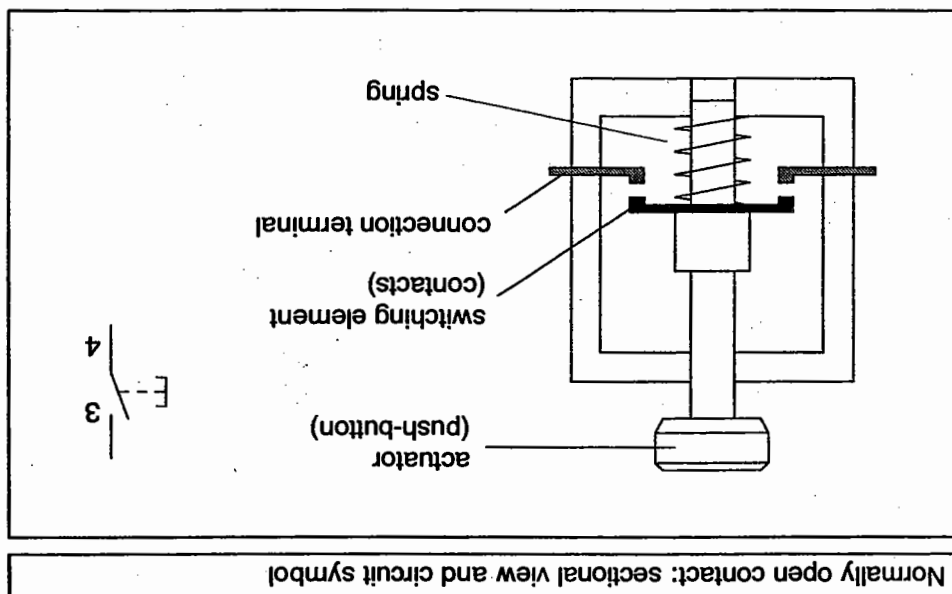

Normally open contact: sectional view and circuit symbol

In the normally open version, the circuit is open when the push-button is in the normal position; i.e. not pressed. The circuit is closed when the control stem is actuated; current then flows to the consuming device. When the control stem is released, the push-button is returned to its original position by spring pressure, and the circuit is then interrupted.

Normally open contact

- A push-button only opens or closes a current circuit for a short time. The selected switching position is only active while the push-button is pressed.
 - In control switches, the two switching positions are mechanically interlocked. A switching position is maintained until the switch is activated once again.
 - Switches are installed in a circuit to open or close the flow of current to the consuming device. These switches are divided into the two main groups "push-button switches" (push-buttons) and "control switches". Both switch types are available for operation with normally closed contacts, normally open contacts or changeover contacts.
 - the direct voltage is then stabilised by the in-phase regulator.
 - a smoothed direct voltage is generated by the rectifier G and the capacitor C.
 - the mains transformer which transforms the alternating voltage of the mains supply (e.g. 220 V) into the output voltage (mostly 24 V).
- A power supply unit consists of the following modules:

3.2 Electrical

input elements

Control switch

Push-button

Normally closed contact

In the normally closed version, the circuit is closed when the push-button is in normal position. The spring action ensures that the contacts remain closed until the push-button is pressed. When the push-button is pressed, the switching contact is opened against the spring pressure. The flow of current to the consuming device is interrupted.

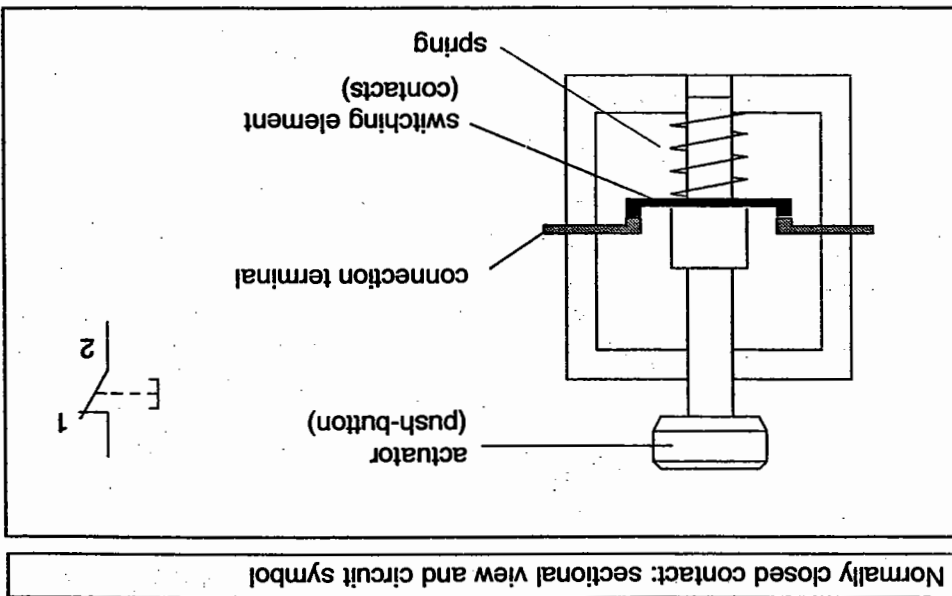

Changeover contact

The third variation is the changeover contact. These contacts combine the functions of normally closed and normally open contacts in one unit. Changeover contacts are used to close one circuit and simultaneously open another. It should be noted, however, that both circuits are momentarily interrupted during changeover.

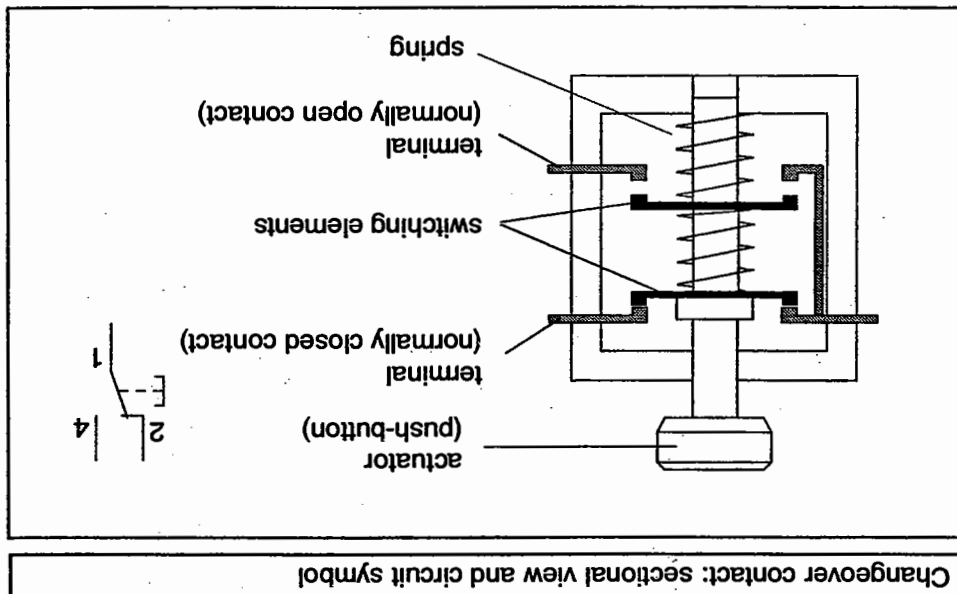

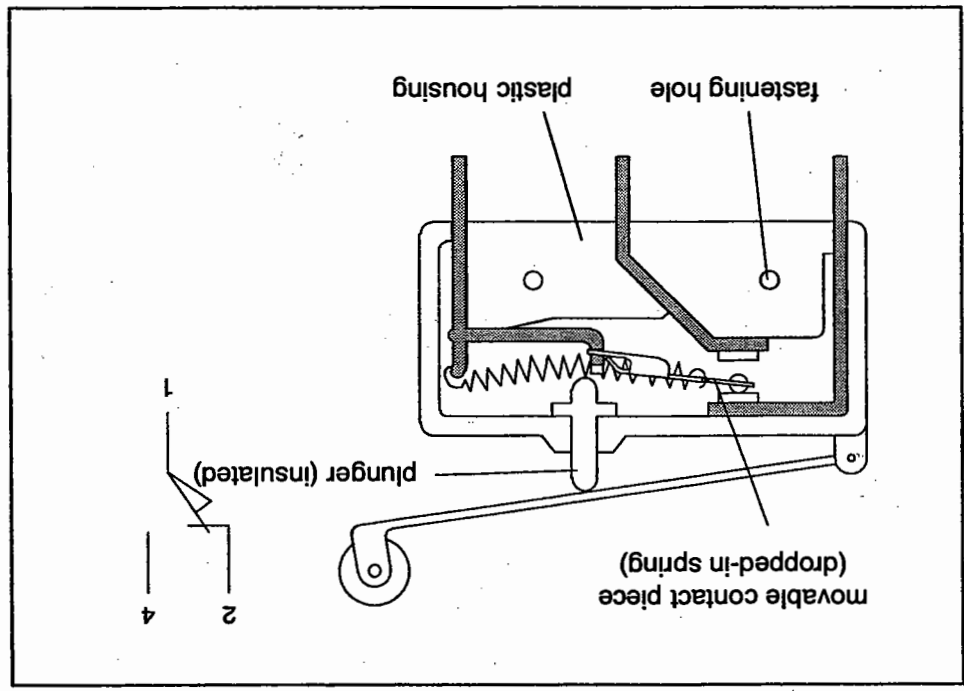

Mechanical limit switch: sectional view and circuit symbol

Pressure switches are used as control or monitoring devices. They can be used to open, close or change between circuits when a preset pressure is reached. The supply pressure acts on a piston surface. The resulting force acts against an adjustable spring pressure. If the pressure is greater than the force of the spring, the piston is moved and actuates the contact assembly.

Pressure switch

A mechanical limit switch is an electrical switch which is activated when a machine part or a workpiece is in a certain position. Activation is generally effected by a cam activating a movable operating lever. Limit switches are normally equipped with changeover contacts capable of performing closing, opening or changeover of circuits.

Limit switch

- recording the proximity i.e. the position or the end position of drive components.
 - measurement and monitoring of pressure and temperature of the pressure fluid,
- Sensors are used to record information about the status of a system and to pass this information on to the control. In electro-hydraulic systems, sensors are mainly used for the following tasks:

3.3 Sensors

In pressure switches with mechanically actuated contact assemblies, a diaphragm, a bellows or a Bourdon spring can be used in place of the helical spring.

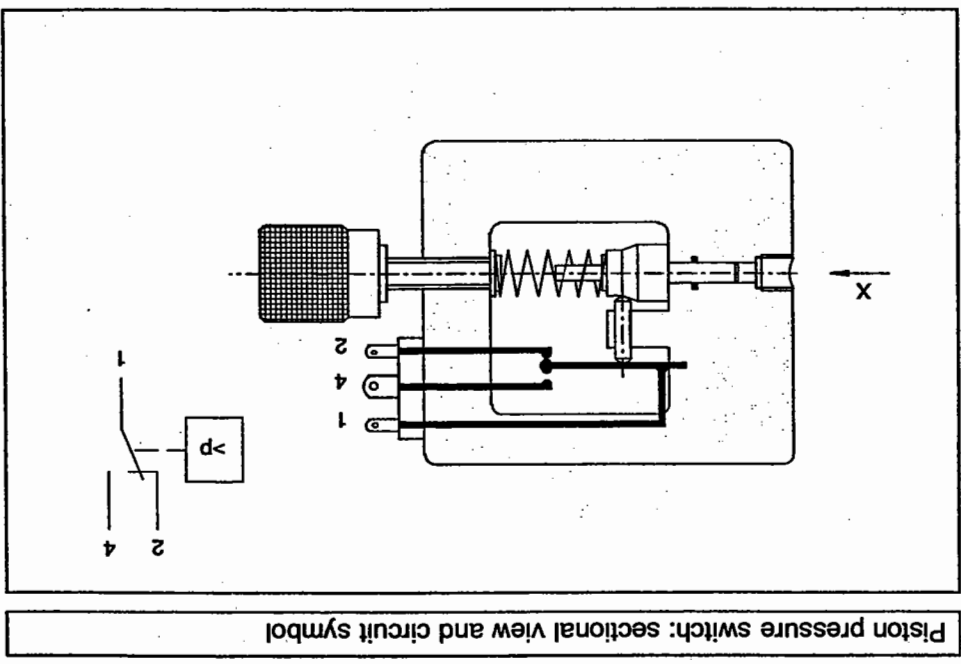

Recently, increasing use has been made of diaphragm pressure switches, where the contact is no longer mechanically actuated but electronically switched. This also requires the use of pressure- or force-sensitive sensors which exploit one of the following physical effects:

- the resistance effect (diaphragm with strain gauge, change in electrical resistance with shape change),
- the piezoresistive effect (change in electrical resistance with change in mechanical tension),
- the piezoelectric effect (generation of an electrical charge through mechanical stress),
- the capacitive effect (change in capacitance with change in mechanical stress).

The pressure-sensitive element in this process is created through diffusion, vapour-depositing or etching on the diaphragm. A suitable protective electronic circuit supplies an amplified analogue signal. This signal can be used for pressure indication or for further switching operations.

Non-contacting proximity sensors differ from mechanically actuated limit switches by virtue of the means of actuation, without external mechanical actuating force. A distinction is made between the following groups of proximity sensors:

- magnetically activated proximity sensors (Reed switch),
- inductive proximity sensors,
- capacitive proximity sensors and
- optical proximity sensors.

Reed switches

Reed switches are magnetically actuated proximity switches. They consist of two contact reeds housed in a glass tube filled with inert gas. When the switch enters a magnetic field e.g. the magnet on a cylinder piston, the reeds are closed and output an electrical signal. The opening function of reed contacts can be achieved by pre-stressing the contact reeds using small magnets. This initial stress is overcome by the considerably stronger switching magnets. Reed switches are characterised by the following properties:

- long service life,
- maintenance-free,
- switching time ≈ 0.2 ms,
- limited response sensitivity,
- unsuitable for areas with strong magnetic fields (e.g. resistance welding machines).

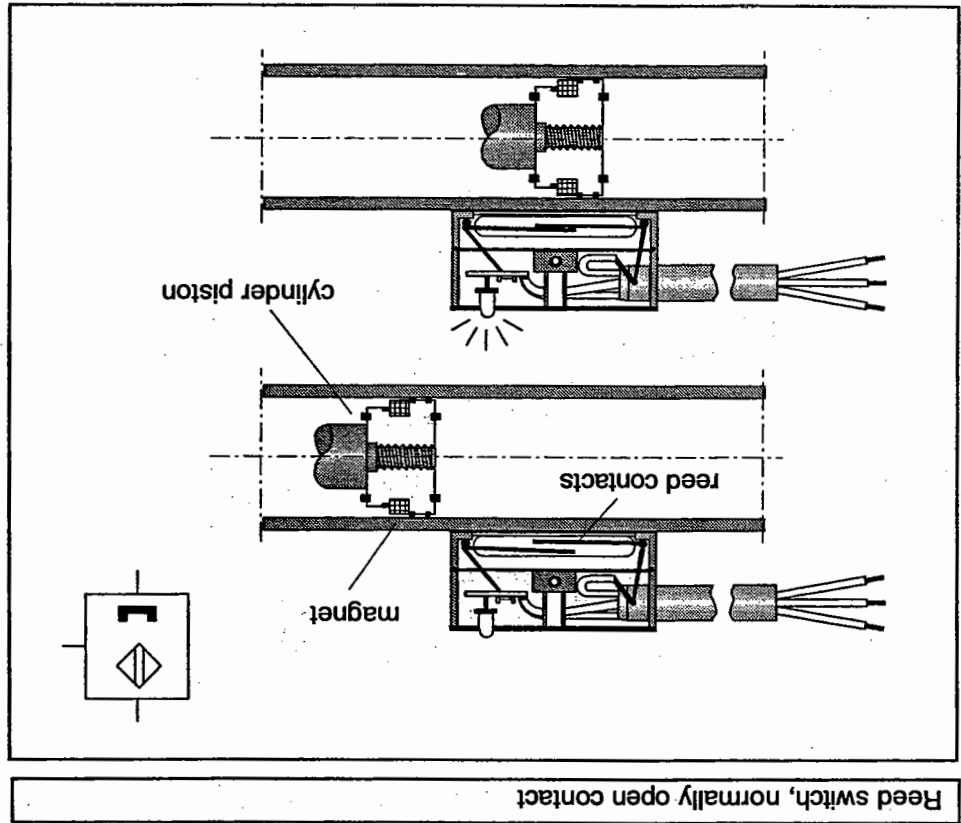

- all materials with good electrical conductivity are recognised by inductive proximity sensors. Their function is confined to neither magnetisable materials nor metals; they also recognise graphite, for example.
 - objects can be detected either moving or stationary.
 - objects with large surface areas are recognised more readily than objects which are small compared to the sensor area (e.g. metal).
 - they are chiefly used as digital sensors.
- Inductive proximity sensors are characterised by the following properties:

An inductive proximity sensor consists of an oscillating circuit (1), a triggering stage (2) and an amplifier (3). When a voltage is applied to the terminals, the oscillating circuit generates a high-frequency electro-magnetic field which is emitted from the end face of the proximity sensor. If a good electrical conductor is introduced into this oscillating magnetic field, the oscillating circuit is damped. The downstream triggering stage evaluates the oscillating circuit signal and activates the switching output via the amplifier.

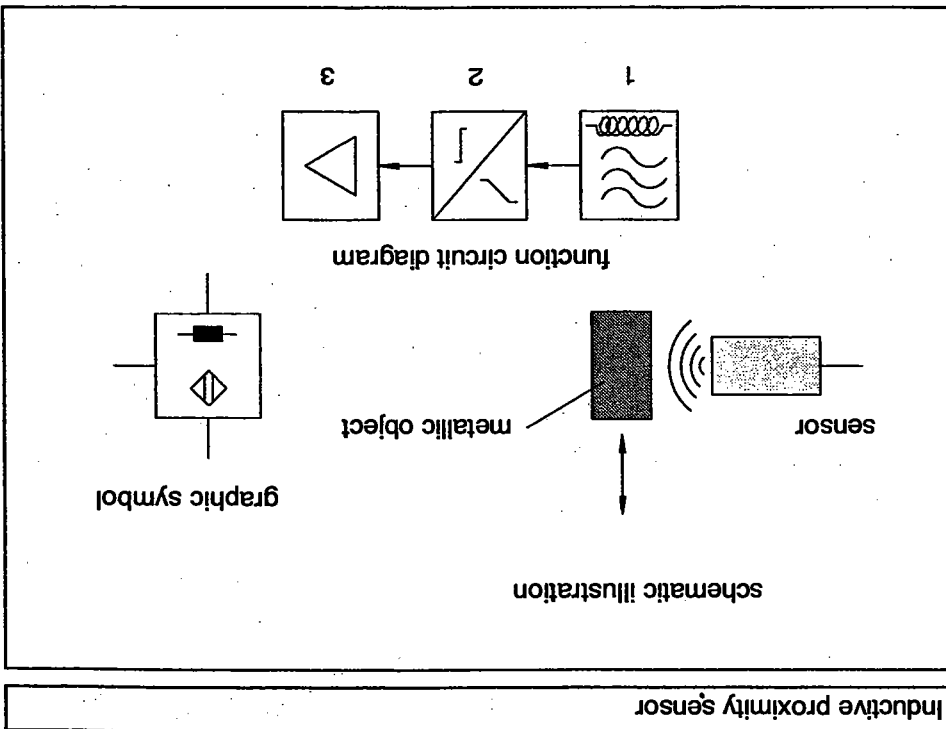

Inductive proximity sensors

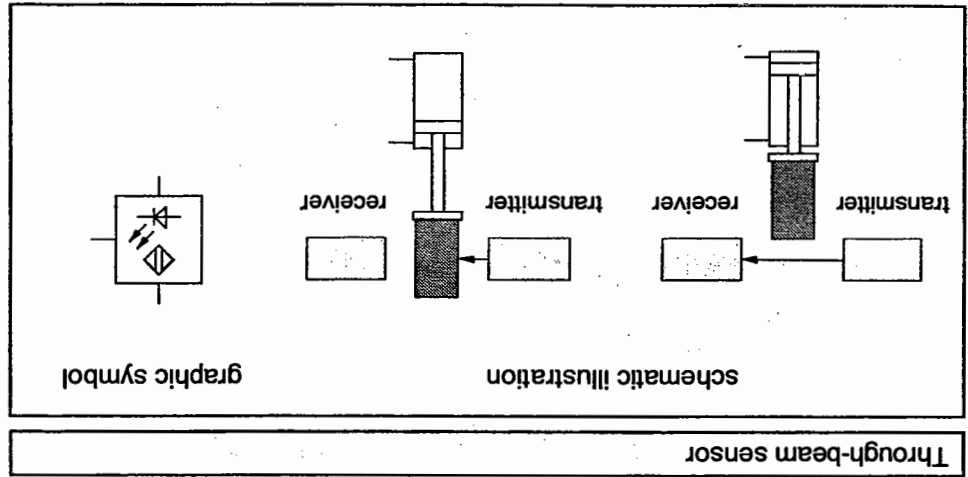

The through-beam sensor consists of spatially separated transmitter and receiver units. The components are mounted in such a way that the transmitter is aimed directly at the receiver. If the light beam is interrupted, the contacts open or close.

- through-beam sensors
- retro-reflective sensors
- diffuse sensors

We distinguish between three types of optical proximity sensors:

Optical proximity sensors

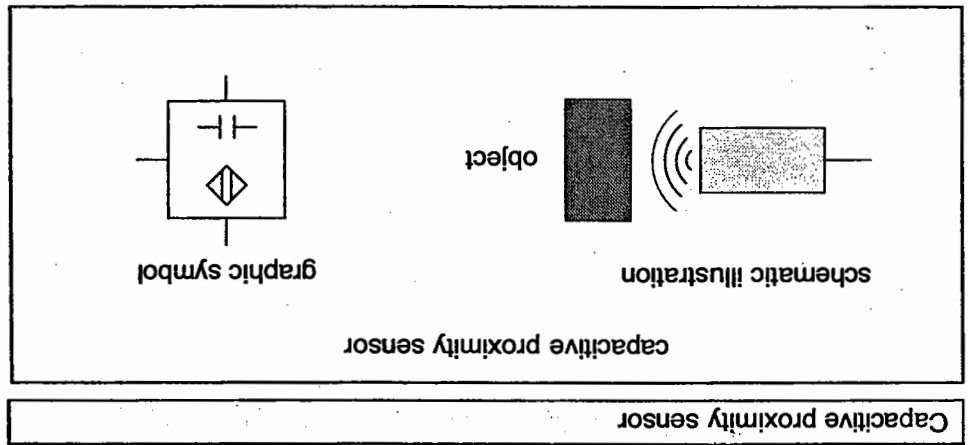

Capacitive proximity sensors measure the change in capacitance in the electrical field of a capacitor caused by the approach of an object. The proximity sensor consists of an ohmic resistor, a capacitor (RC oscillating circuit) and an electronic circuit. An electrostatic field is built up in the space between active electrode and earth electrode. If an object is then introduced into this stray field, the capacitance of the capacitor increases, thus detecting not only highly conductive materials, but also all insulators which possess a high dielectric constant. Materials such as plastics, glass, ceramics, liquids and wood, for example.

Capacitive proximity sensors

In retro-reflective sensors, the transmitter and the receiver are mounted side by side in a common housing. For the correct function of these sensors, a reflector must be mounted in such a way that the light beam emitted by the transmitter is more or less totally reflected onto the receiver. Interruption of the light beam causes the sensor to switch.

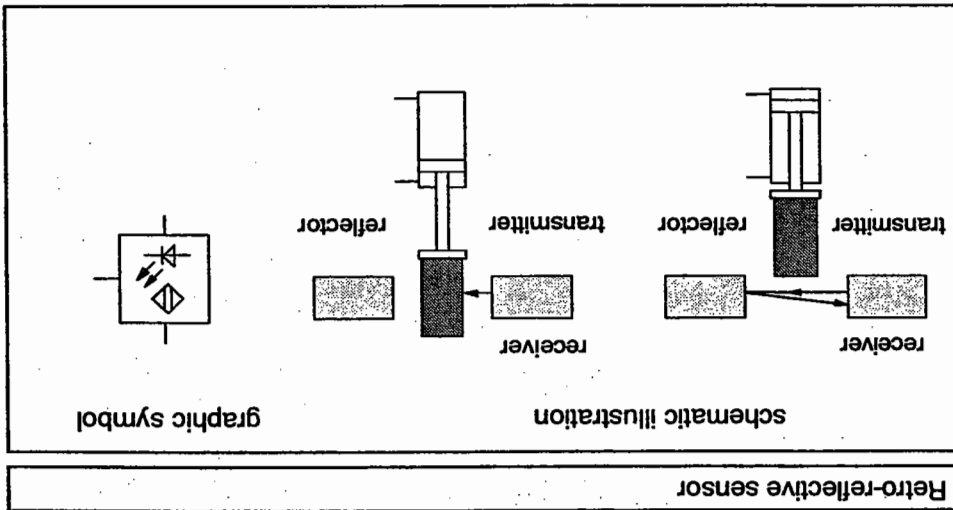

The transmitter and receiver of the diffuse sensor are mounted in a similar way to that of the retro-reflective sensor. If the transmitter is aimed at a reflecting object, the reflected light is absorbed by the receiver and a switching signal is generated. The greater the reflection properties of the object in question, the more reliably the object can be detected.

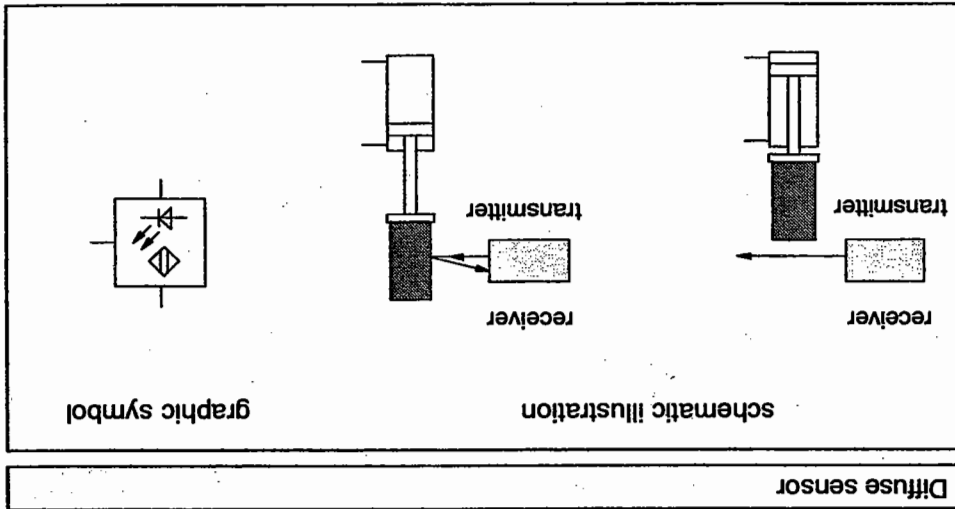

The representation of relays and contactors in the electrical circuit diagram is identical, as is their operating principle.

- Relays are used to switch relatively small outputs and currents;
- contactors to switch relatively large outputs and currents.

Relays are electromagnetically actuated switches. They consist of a housing with electromagnet and movable contacts. An electromagnetic field is created when a voltage is applied to the coil of the electromagnet. This results in attraction of the movable armature to the coil core. The armature actuates the contact assembly. This contact assembly can open or close a specific number of contacts by mechanical means. If the flow of current through the coil is interrupted, a spring returns the armature to its original position.

Relay: sectional view and circuit symbol

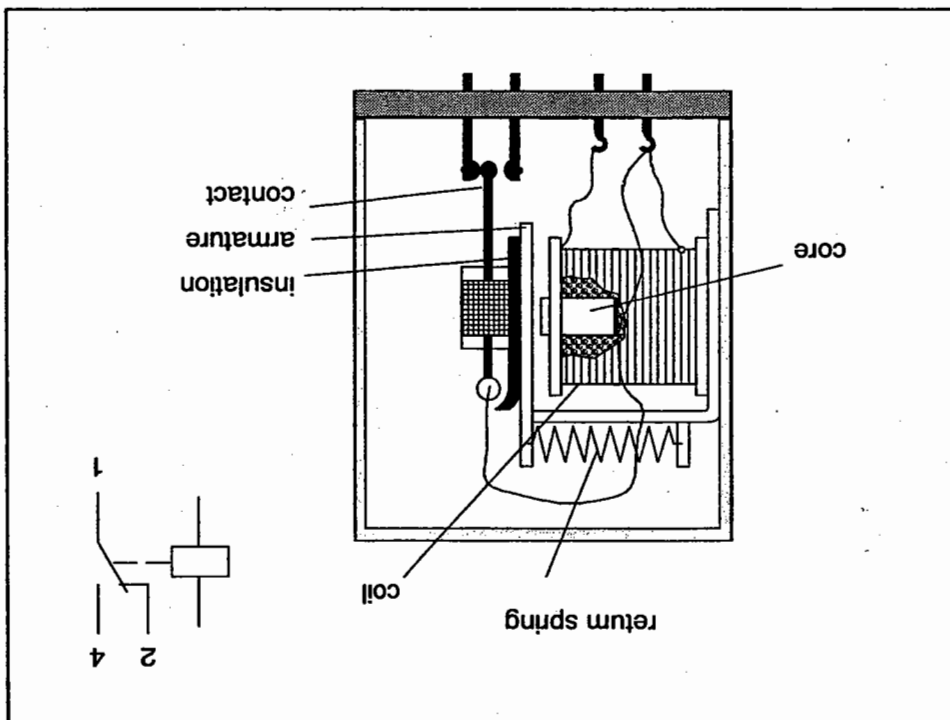

There are various types of relay; e.g. time-delay relays and counter relays. Relays can be used for various regulating, control and monitoring functions:

- as interfaces between control circuits and load circuits,
- for signal multiplication,
- for separation of direct current and alternating current circuits,
- for delaying, generating and converting signals and
- for linking information.

Application examples

Terminal designations and circuit symbols

Depending on design, relays possess varying numbers of normally closed contacts, normally open contacts, changeover contacts, delayed normally closed contacts, delayed normally open contacts and delayed changeover contacts. The terminal designations of the relays are standardised (DIN EN 50 005, 50011-13):

- relays are designated K1, K2, K3 etc.
- the coil terminals are designated A1 and A2.
- the contacts switched by the relay are also designated K1, K2 etc. in circuit diagrams.
- There are additionally two-digit identification numbers for the switching contacts. The first digit is for numbering of all existing contacts (ordinal number), while the second digit denotes the type of contact (function number).



Function numbers for relays

1	2	3	4	5	6	7	8
normally closed contact	normally open contact	normally closed contact, time delay	normally open contact, time delay	changeover contact	changeover contact, time delay	1	2
5	6	7	8	1	2	3	4

Circuit symbols and terminal designations of a relay

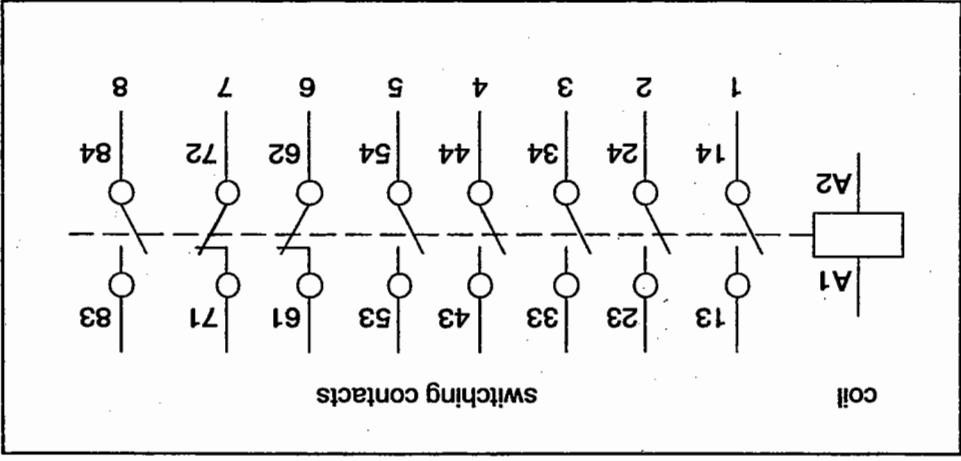

Contactor

Contactors work on the same basic principle as relays. The typical features of a contactor are:

- double-break (2 break points per contact),
- positive-action contacts and
- closed arcing chambers (spark arresting chambers).

In line with DIN 40 719, contactor combinations for switching on three-phase motors are designated by the letter K (for contactor) and M (for motor) as well as a serial number. The serial number identifies the function of the device; for example: K1M = mains contactor, three phase, variable pole, single speed.

- For the purpose of classification, contactors with main contact elements for power switching are called power contactors (main contactors).
 - Contactors which only switch auxiliary contacts (control contacts) are called contactor relays (control contactors).
 - The auxiliary contacts can be used to simultaneously switch further control functions or logic operations.
 - Outputs of 4 - 30 kW are switched via main contact elements.
- A contactor possesses several contact elements, normally between 4 and 10. There are also different types of contactors with various combinations of normally closed contacts, normally open contacts, changeover contacts, delayed normally closed contacts etc. The contacts are divided into main contact elements and auxiliary contacts (control contacts).

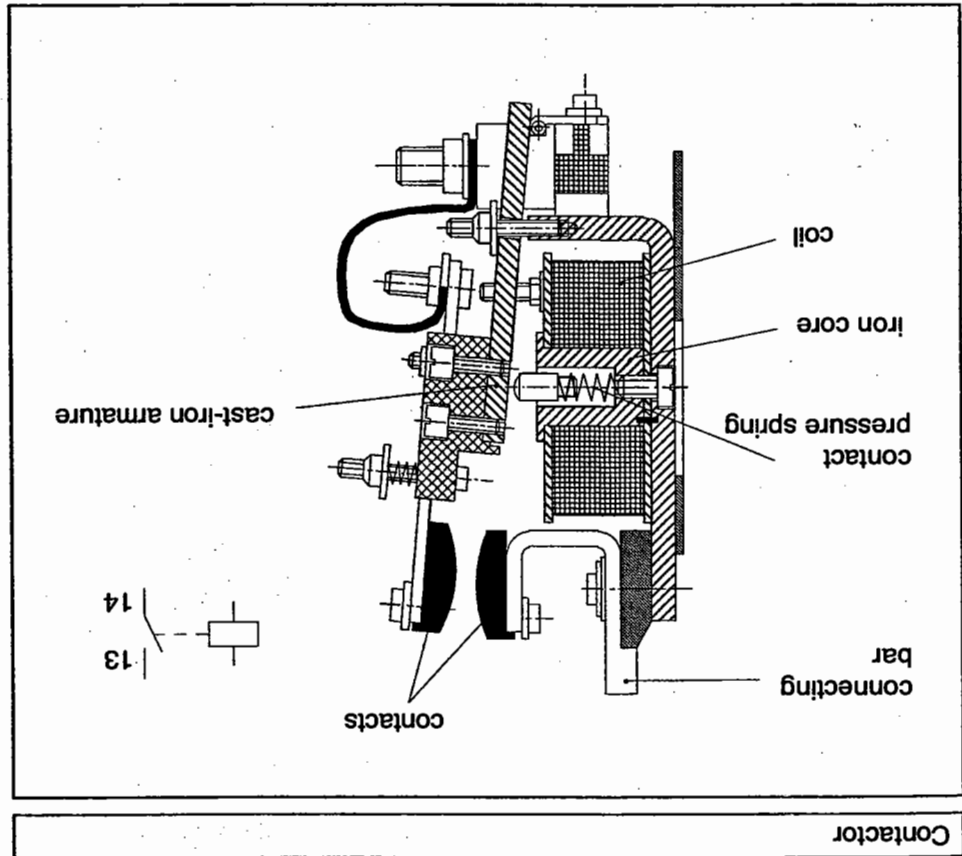



In electro-hydraulics, valves are actuated via solenoids. An iron core – the armature – is installed in the coil winding of the solenoid. A non-magnetic plunger is embedded in this armature. If the coil is then supplied with current, a magnetic field is formed which energises the armature. The plunger connected to the armature then switches the valve gate (see illustration on next page).

Solenoids have two end positions:

- The first end position is achieved during conductive continuity (solenoid energises, position C),
 - while the second end position is achieved in de-energised state via a return spring (electro-magnetic decay, position A).
- In each switching operation, the plunger additionally presses against the return spring of the valve, thus reducing its force in the direction of attraction.
- At the beginning of the travel movement the magnetic force is small. The motion of the armature therefore begins with a small idling stroke (position A).
 - The control gate of the directional control valve is not switched (position B) until a greater magnetic force has been reached.

Stroke/force characteristic of a DC solenoid

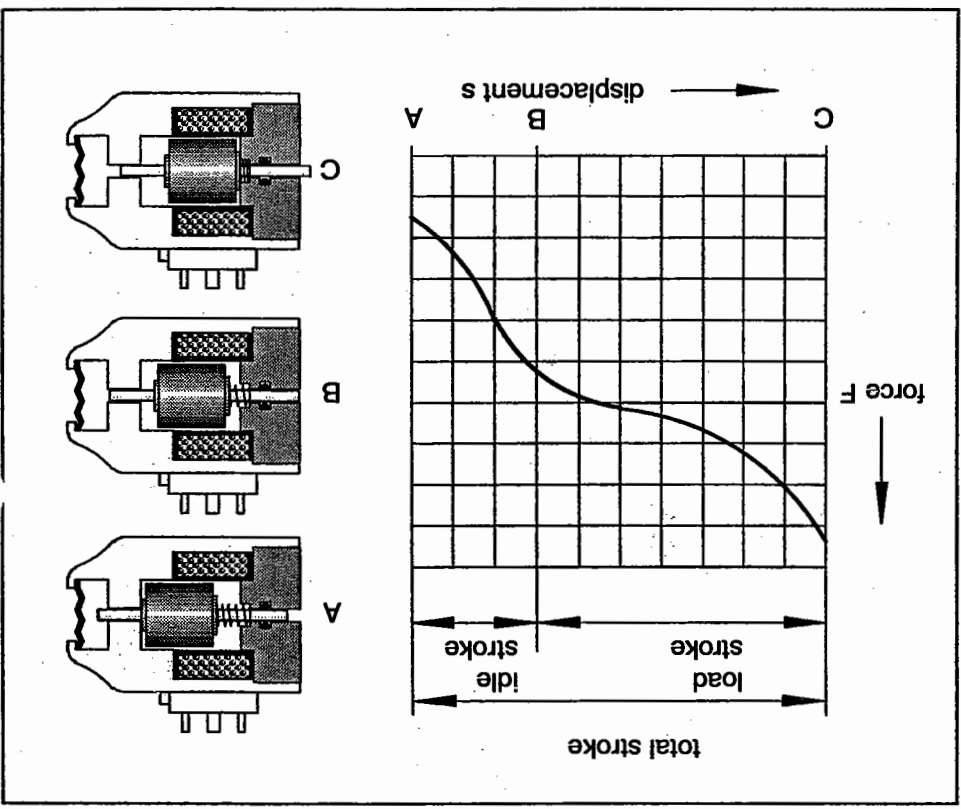

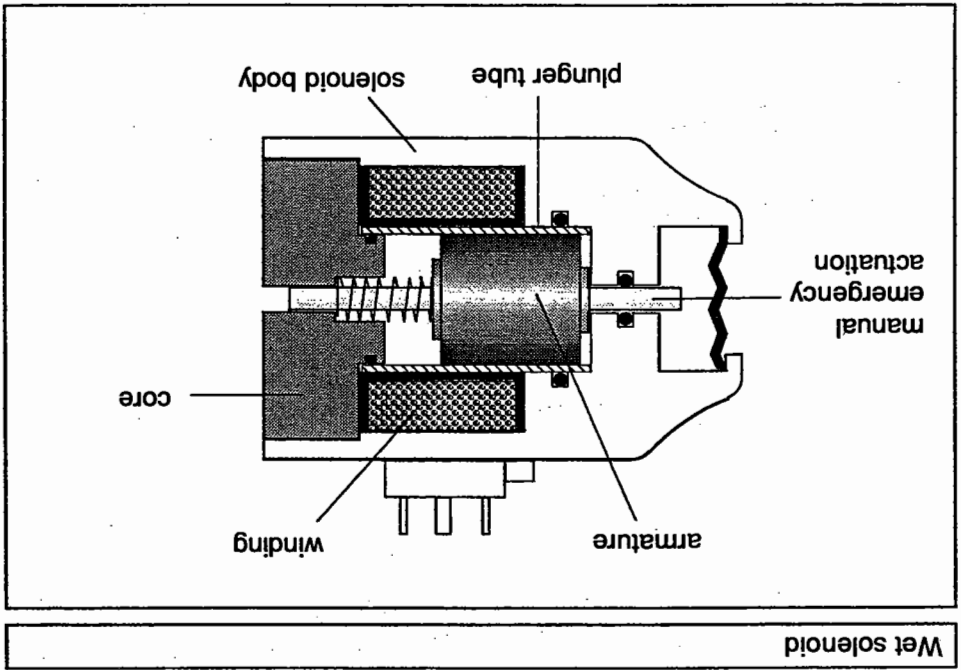

Wet solenoid

- absolute seal-tightness and low friction due to the absence of a dynamically stressed seal at the plunger,
 - greatly reduced corrosion inside the housing and cushioning of switching operations.
- nowadays common type of solenoid are:
 In wet solenoids, the armature chamber of the solenoid contains hydraulic oil, seal-tight (towards the outside). The armature chamber is connected to the tank port to prevent high pressures on the solenoid. The advantages of this

DC solenoids are produced as wet or dry designs, whereas AC solenoids are always dry solenoids.

When a solenoid is switched off, the flow of current is interrupted. The collapse of the magnetic field creates a voltage peak in the opposite direction. A protective spark suppression circuit is essential to prevent damage to the solenoids or the contacts.

There are solenoids for direct current or alternating current. AC solenoids for 230 V are used less and less frequently for reasons of safety (dangerous touch voltage).

DC and AC solenoids

Wet solenoid

Types

Arcing

Dry solenoid

The term "dry solenoid" means that the solenoid is isolated from the oil. The plunger is sealed off from the oil in the valve body by a seal. Therefore, in addition to the spring force and the friction of the control gate, the solenoid has to overcome the friction between plunger and seal.

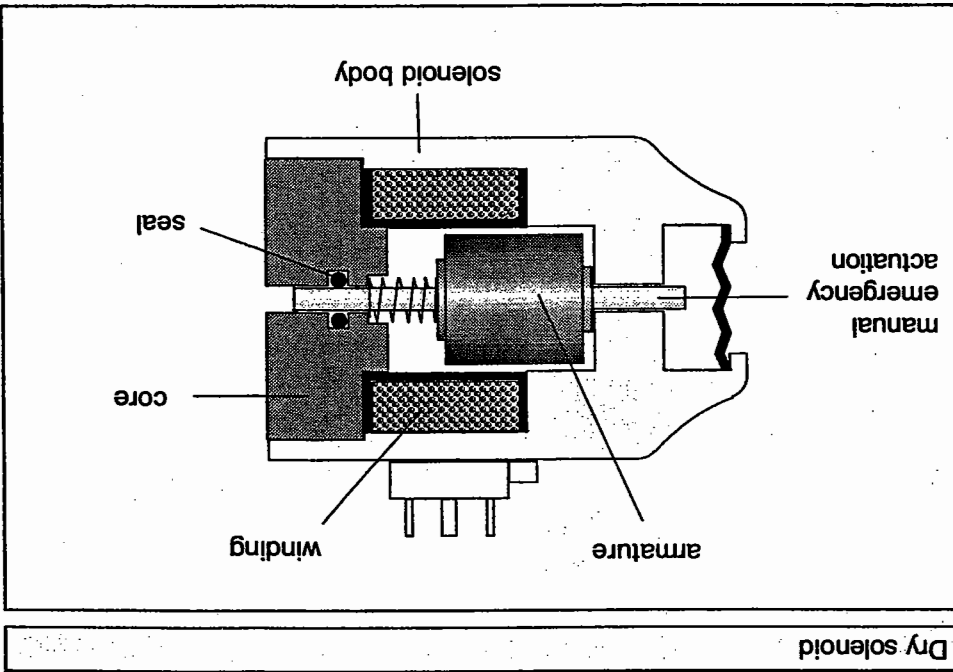

Dry solenoid

Plug connector
for solenoid valves
(line sockets)

When the valves are assembled the solenoid is screwed directly to the valve body. This facilitates replacement in the event of malfunction. Three contacts (plug pins) protrude from the solenoid and it is via these contacts that the solenoid coil is supplied with current. The spacing of the plug-in contacts is laid down in DIN 43 650.

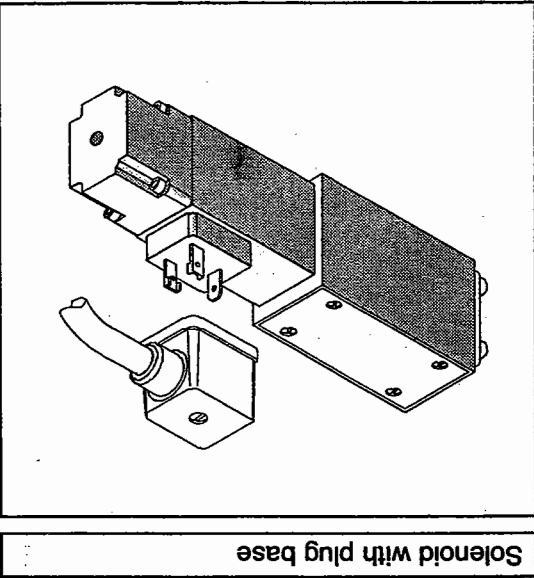

Solenoid with plug base

- circuit with one diode,
- circuit with one capacitor and one resistor.

The two most common circuits are shown in the following illustrations:

To avoid damage to the contacts or the coil, the energy stored in the coil must be discharged gradually after switch-off. A spark suppression circuit is required for this purpose. Various kinds of spark suppression circuit are suitable for this purpose. What is common to all spark suppression circuits, however, is that, after switch-off, the change in the current strength is not sudden but slow and regulated.

The inductivity of solenoid coils causes electro-magnetic energy to be stored when the circuit is switched on. The faster the induced voltage peak. This can cause insulation breakdown in the circuit or destroy the switching contact as a result of an arc (contact-breaking spark).

Spark suppression in solenoid valves

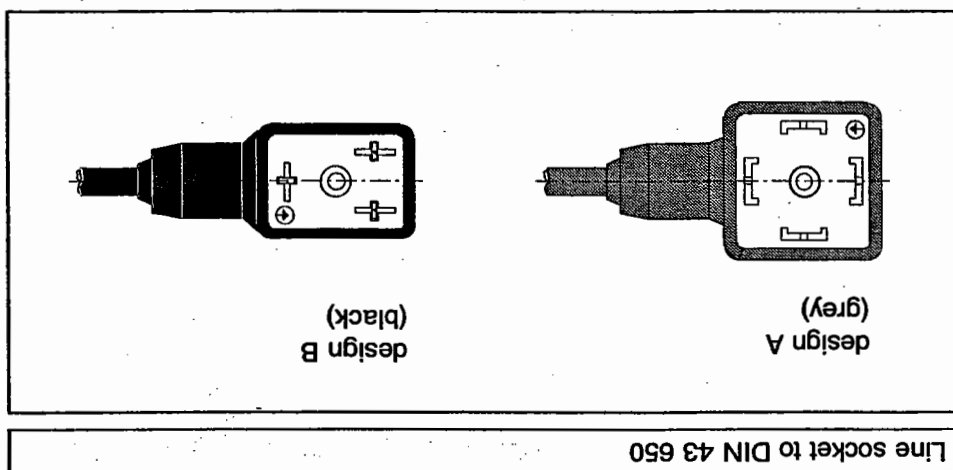

The line sockets are screwed onto these contacts using a captive cheese head screw. A fitted seal between solenoid base and line socket serves as protection against dust and water spray (protection type IP 65 to DIN 40 050). The housing dimensions of the line sockets vary from manufacturer to manufacturer.

The line sockets are screwed onto these contacts using a captive cheese head screw. A fitted seal between solenoid base and line socket serves as protection against dust and water spray (protection type IP 65 to DIN 40 050). The housing dimensions of the line sockets vary from manufacturer to manufacturer.

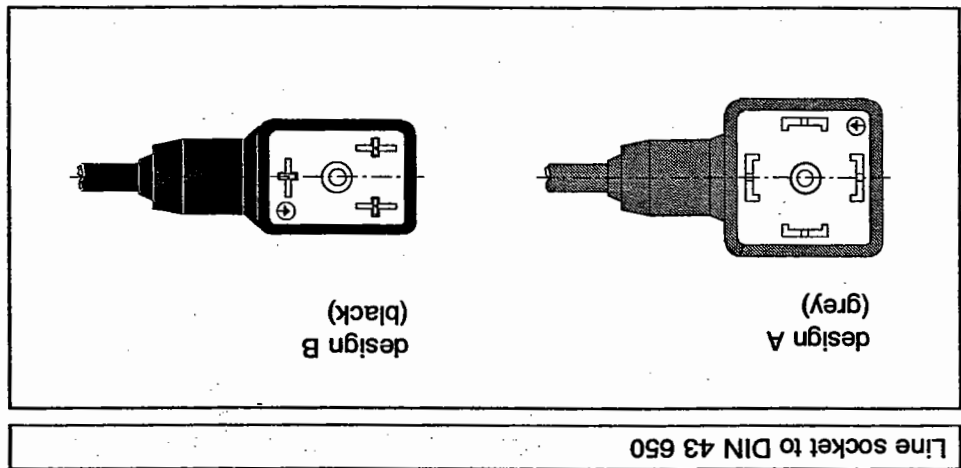

The inductivity of solenoid coils causes electro-magnetic energy to be stored when the circuit is switched on. The faster switch-off is effected, the faster the energy is discharged and the higher the induced voltage peak. This can cause insulation breakdown in the circuit or destroy the switching contact as a result of an arc (contact-breaking spark).

To avoid damage to the contacts or the coil, the energy stored in the coil must be discharged gradually after switch-off. A spark suppression circuit is required for this purpose. Various kinds of spark suppression circuits are suitable for this purpose. What is common to all spark suppression circuits, however, is that, after switch-off, the change in the current strength is not sudden but slow and regulated.

The two most common circuits are shown in the following illustrations:

- circuit with one diode,
- circuit with one capacitor and one resistor.

When suppression using a diode, care should be taken to ensure that the diode is polarised in the direction of blocking when the contact is

Using diode

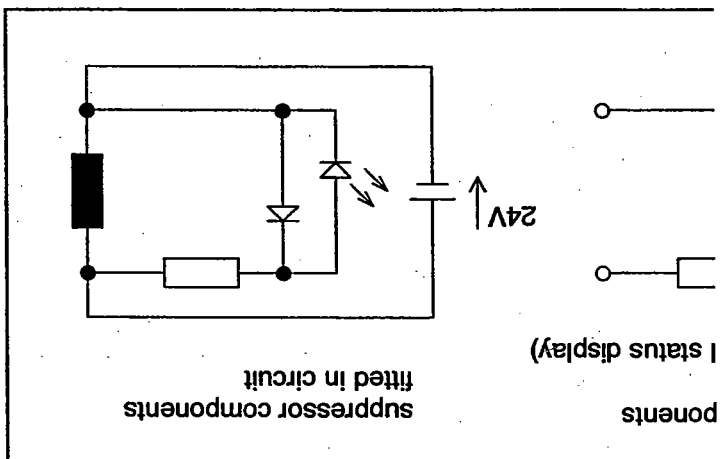

polarity of the supply voltage is fixed. This allows connection to the coil for switching status display. The most practical for the protective circuit and the switching status display is plugged directly onto the solenoid coil below the connecting plug. Also be directly incorporated into the connecting plug.

Using capacitor and resistor

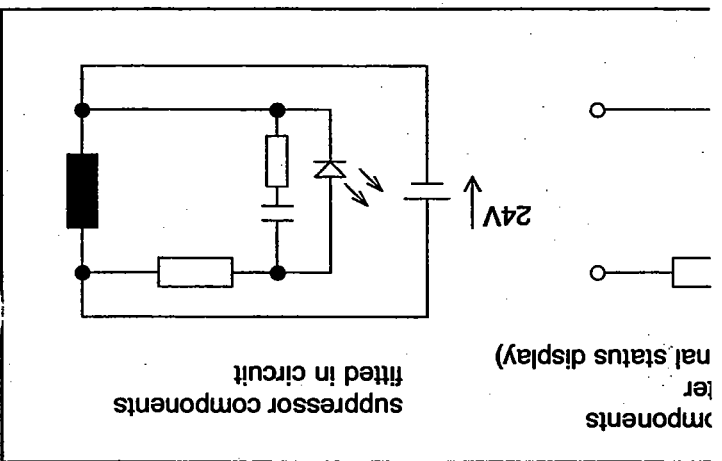

Using components

I status display

3.6 Control cabinet

In all electrically activated systems, the signal control section is installed in a control cabinet. Depending on their size and intended use, these control cabinets are made of plastic or sheet metal. When constructing control cabinets, the following standards must be observed:

- DIN 41 488, Parts 1 to 3 stipulate panel widths for control cabinets and switchgear.
- the mounting racks for relays, contactors, stored-program controls (PLC's), plug-in cards etc. and the design of electronic devices, front panels and racks for 19" frames are governed by DIN 41 494, Part 2.
- VDE 0113 contains guidelines concerning the type and structure of control cabinets, as well as regulations on the mounting height of the equipment, which has to be accessible for adjustment and maintenance work.
- the standards DIN 40 050 and IEC 144 contain provisions on the protection (shock protection) of personnel against electrical equipment in the form of housings or cover panels and also lay down provisions on the protection of equipment against water and dust penetration as well as details of internally agreed protection types.

The signal-processing elements, such as relays and contactors, are plugged onto a mounting rail (top-hat rail to DIN EN 50 022-27, 32 and 35) installed in the control cabinet. The electrical connections to the sensors outside the control cabinet are routed via a terminal strip. This is also plugged onto a mounting rail.

Terminal allocation

The control cabinet is generally fitted with a distribution board via which all input and output signals are routed. The electrical circuit diagrams and the terminal allocation list are required for production, installation and maintenance of the control cabinets.

- The terminals (distribution boards DIN 43 880) are drawn on the electrical circuit diagrams.
- In the terminal allocation list drawn up on the basis of the circuit diagram, the internal (inside the control cabinet) and external connections (on the system) are each allocated to one side of the terminal strip. Each terminal is designated by an X and a serial number.

A detailed description of circuit documentation can be found in DIN 40 719, with details of terminal designations in DIN EN 50 011.

Example

The following example shows how the electrical circuit diagram and the terminal allocation list for the control cabinet are drawn up on the basis of a task definition. The piston rod of a cylinder (1.0) is to advance when a push-button (S1) is pressed once. A further start condition is that the piston rod is in the retracted position – with the proximity switch (B1) in the actuated state. The speed can be varied via a one-way flow control valve. When it reaches the forward end position, the piston rod is to be reversed by the electrical signal from the limit switch (S2).

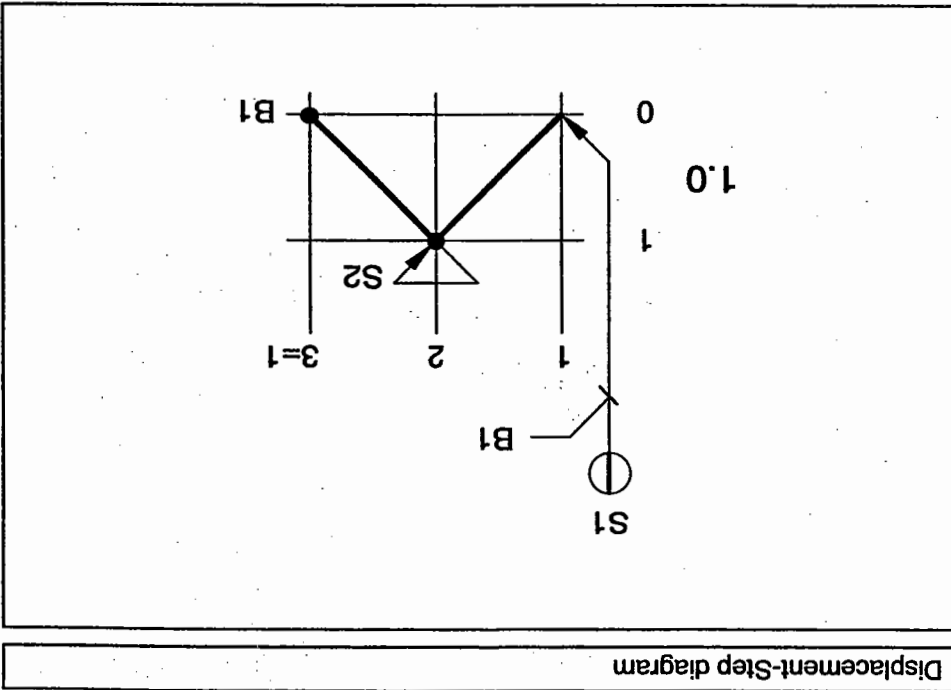

Hydraulic circuit diagram

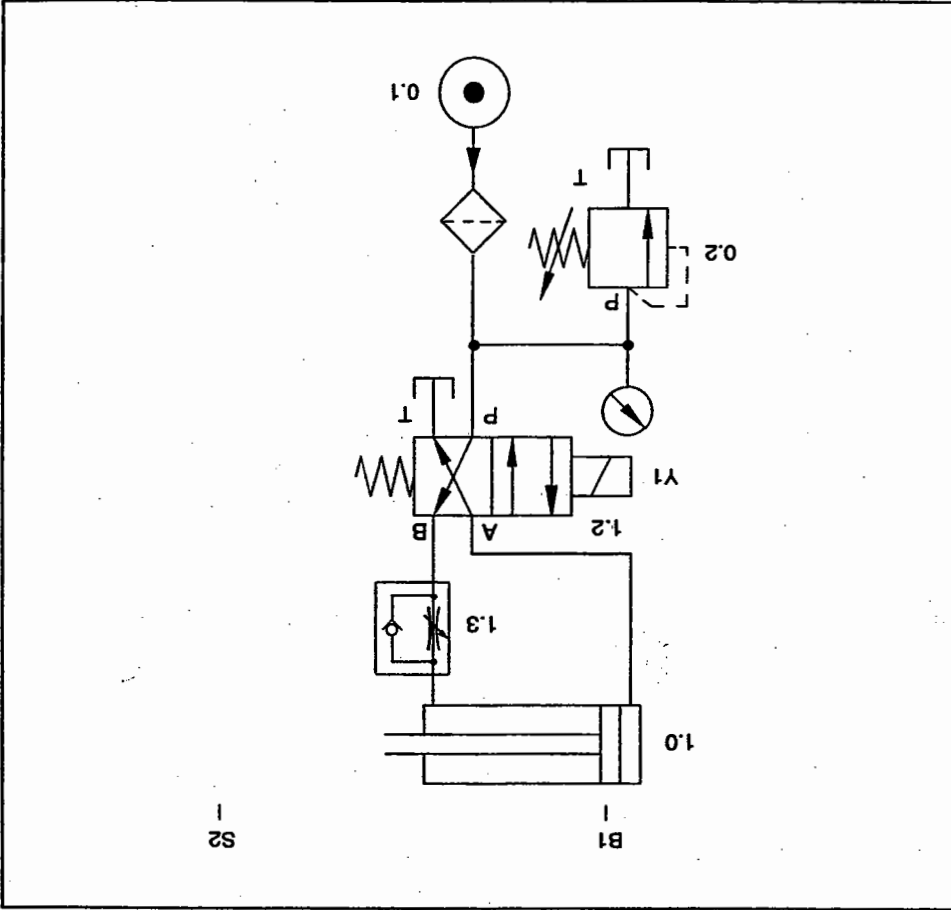

Terminal allocation list

Destination		Terminal no. X,.....		Connecting bridge		Destination	
Connection	Component	Connection	Component	Connection	Component	Connection	Component
9	X1	1	+24V	○			
12	X1	2		○			
14	X1	3		○			
23	X1	4		○			
11	X1	5	0V	○			
11	X1	6		○			
A2	X1	7		○			
17	X1	8		○			
1	X1	9		○			
A1	X1	10		○			
5	X1	11		○			
2	X1	12		○			
13	X1	13		○			
3	X1	14		○			
13	X1	15		○			
13	X1	16		○			
8	X1	17		○			
		18		○			
		19		○			
		20		○			
		21		○			
		22		○			
		23		○			
		24		○			
		25		○			

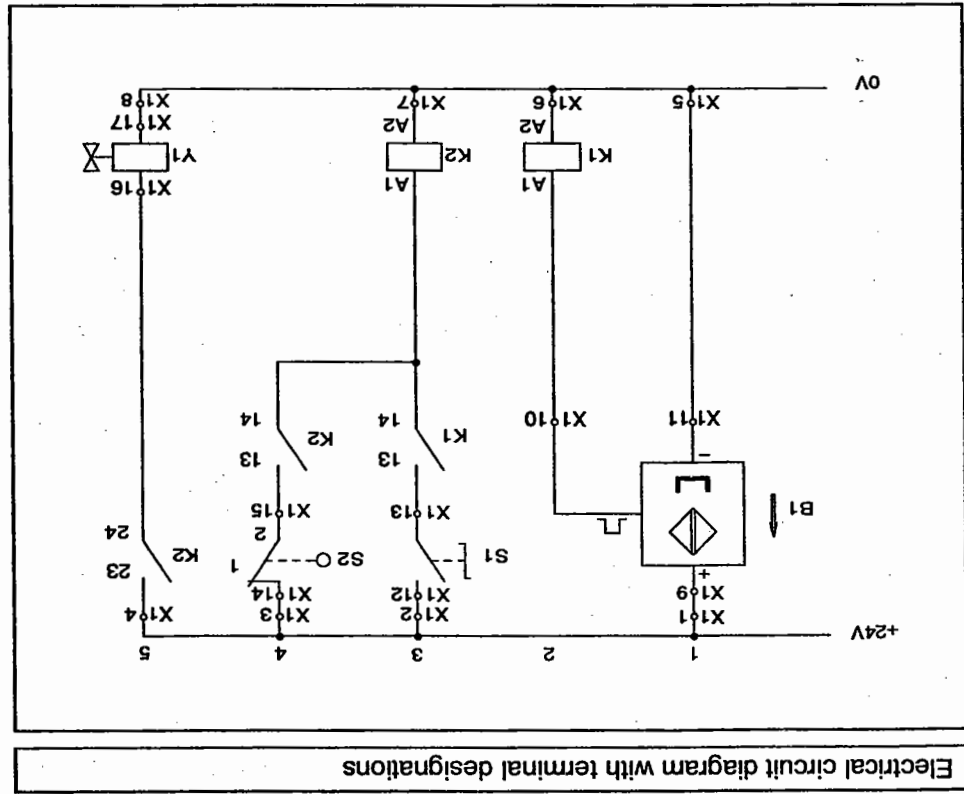

3.7 Voltage supply of an electro-hydraulic system

A supply voltage of 24 V DC is required for the signal and power control sections. The power supply section consisting of hydro pump and electric drive motor requires either 220 V or 380 V AC. The example shown is the circuit of the electrical drive motor for a hydraulic pump.

Voltage supply for an electric motor (3-phase)

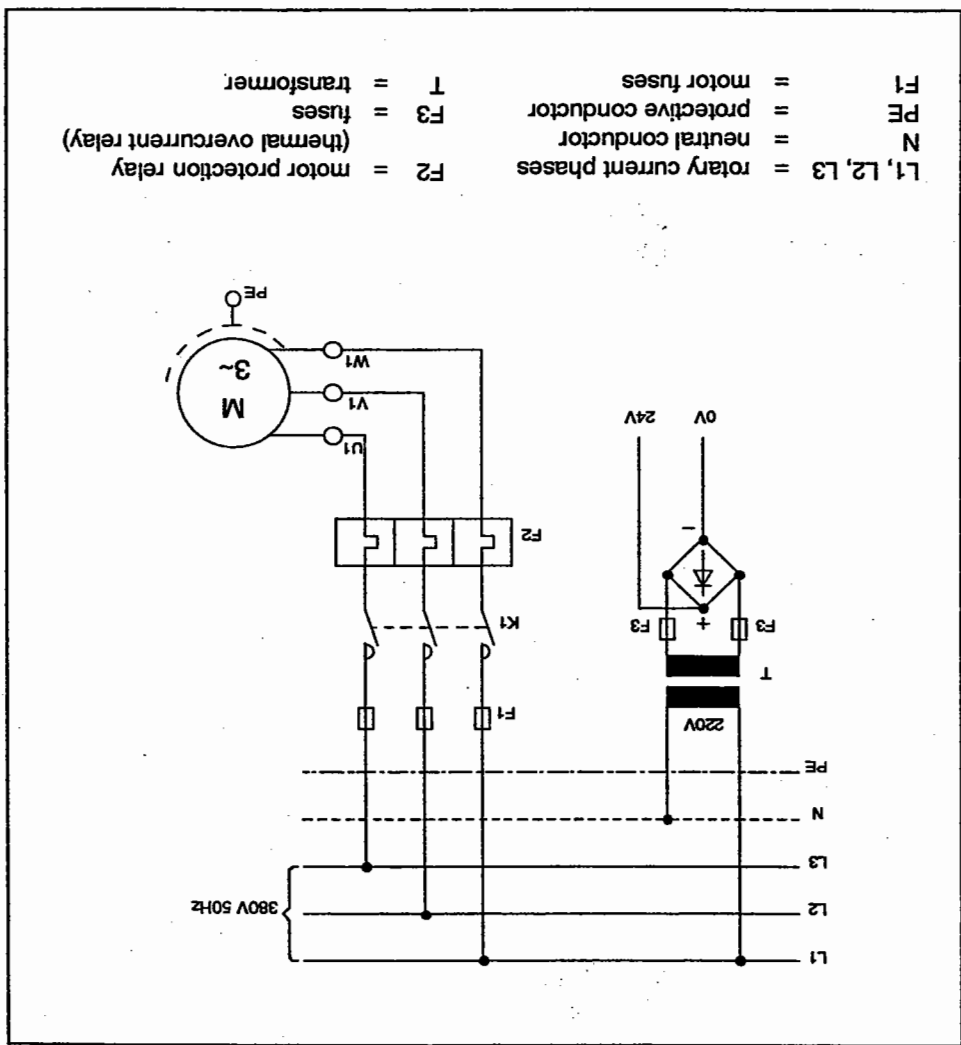

Only suitably qualified electricians may perform work on electrical systems with voltages exceeding 50 volts AC/120 volts DC. It is strictly forbidden for others to perform work on such systems (danger to life and limb!).



Safety note

The controls shown here all use a safe low voltage of 24 V DC. Safety voltages are voltages rated up to 50 V AC or 120 V DC. The use of these voltages rules out the possibility of coming into contact with dangerous voltages.

Safety recommendations

Chapter 4



4.1 General safety recommendations

High pressures, temperatures and forces occur in electro-hydraulic systems. Energy is also stored, sometimes in large quantities. A whole series of safety measures is necessary to rule out the possibility of danger to personnel and equipment during the operation of electro-hydraulic systems. In particular, the valid safety regulations for electro-hydraulic systems are to be observed!

Regulations and standards

The following safety regulations apply for the field of hydraulics:

- accident prevention regulations, directives, safety rules and the testing guidelines of the employers' liability insurance associations,
- regulations on pressurised gas vessels and filling systems (pressure vessel regulations),
- DIN standards, VDI directives, VDMA standard sheets and technical rules for pressure vessels, containing in particular, notes and regulations on dimensions, design, calculations, materials and permissible loads as well as stipulations on functions and requirements.

Electro-hydraulic systems must comply not only with the regulations on hydraulic systems but also with the regulations on electrical systems and components (e.g. DIN VDE 0100).

4.2 Safety recommendations for electro-hydraulic systems
Design of an electro-hydraulic system

Install the **EMERGENCY STOP** push-button in a place where it can be easily reached.
Use standardised parts only.
Enter all alterations in the circuit diagram immediately.
The rated pressure must be clearly visible.
Check whether the installed equipment can be used at the maximum operating pressure.
The design of suction lines should ensure that no air can be drawn in.
Check the oil temperature in the suction line to the pump. It must not exceed 60 °C.
The piston rods of the cylinders must not be subjected to bending loads or lateral forces. Protect piston rods from dirt and damage.

Do not operate systems or actuate switches if you are not totally sure what function they perform.

All setting values must be known.

Do not switch on the power supply until all lines are connected. Important: check that all return lines (leakage lines) lead to the tank.

When starting up the system for the first time, open the system pressure relief valve almost completely and gradually set the system to the operating pressure. Pressure relief valves must be installed in such a way that they cannot become ineffective.

Carefully clean the system prior to start-up, then change the filter cartridge.

Vent system and cylinders.

In particular, the hydraulic lines to the reservoir are to be carefully vented. It is generally possible to effect venting at the safety and shut-off block of the reservoir.

Special care is needed when handling hydraulic reservoirs.

Before the reservoirs are started up, the regulations stipulated by the manufacturer are to be studied carefully.

Repair work may not be effected on hydraulic systems until the fluid pressure of the reservoir has been vented. If possible, separate the reservoir from the system (using a valve). Never drain the reservoir unthrottled! Installation and operation are governed by the Technical Rules for Pressure Vessels (TRB).
When repairs are completed effect a new start-up in line with the safety regulations listed above.
All hydraulic reservoirs are subject to the provisions of the pressure vessel regulations and must be inspected at regular intervals.

Start-up of an electro-hydraulic system

Repair and maintenance of an electro-hydraulic system

4.3 Safety recommendations for electrical systems

Effect of electric current on the human body

VDE 0113 contains stipulations governing the electrical equipment of machines and processing machines with mains voltages up to 1000 V. These regulations are wide-ranging and apply to the electrical equipment of all stationary and mobile machines as well as machines in production lines and conveying systems.

When live parts of an electrical system are touched, electric current flows through the human body. The effect of the current increases

- with increasing current and
- duration of contact

There are two threshold values:

- if the electric current is lower than the perceptibility threshold, it has no effect on human beings.
- up to the releasing threshold, an electric current is perceived, but the possibility of injury or danger is unlikely.
- above the releasing threshold, the muscles contract and cardiac function is impaired.
- values above the fibrillating threshold lead to ventricular fibrillation and cardiac arrest as well as cessation of breathing and consciousness; lengthy contact also causes serious burns. There is acute danger to life and limb!

The two following diagrams show that – compared to DC voltage lines – AC power supply networks (50/60 Hz) with relatively small currents can endanger human life.

Hazard zones with alternating current (50/60Hz)

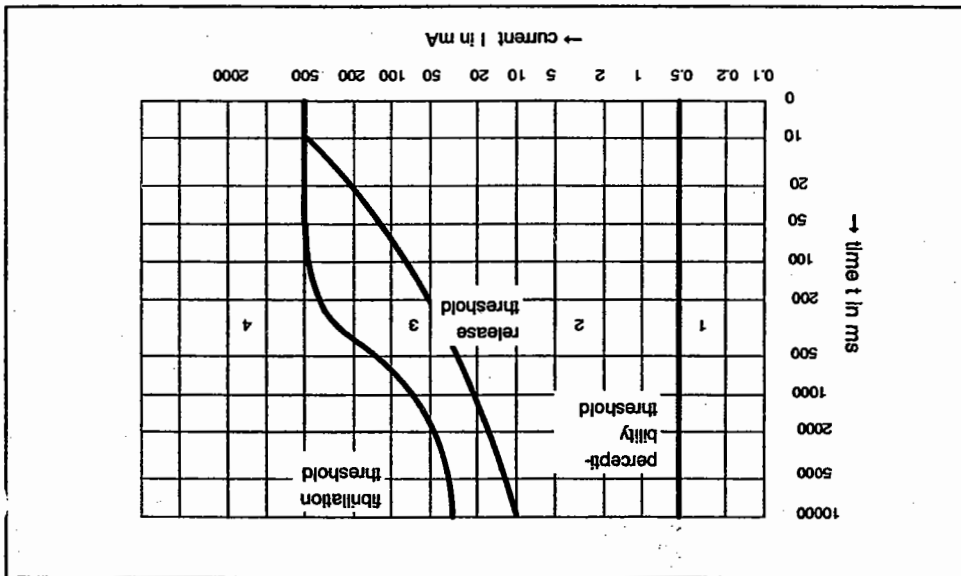

N.B. Under extremely unfavourable conditions (clothes damp with perspiration, large contact area) even voltages under 65 V can be fatal!

$$50 \text{ mA} \cdot 1300 \Omega = 65 \text{ V}$$

There is serious risk to life and limb from currents of 50 mA upwards. Taking into account the internal resistance, this is equivalent to a contact voltage of

When electrical current flows through the body to earth, 1300 Ω is given as an approximate figure for the internal resistance of the body.

- the higher the voltage
- and the lower the internal resistance of the person concerned.

In line with Ohm's law, the flow of current and thus the risk to human safety is greater: internal resistance of the human body

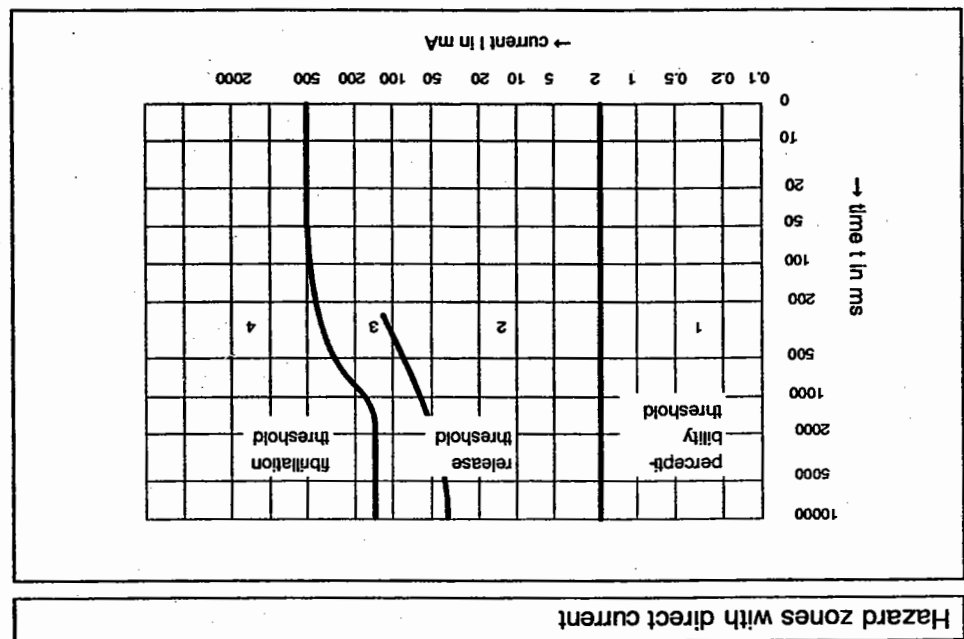

Protective measures in the signal control section

The supply voltage in the signal control section of electro-hydraulic systems is normally 24 V, and thus way below the critical contact voltage of 65 V. The mains voltage is stepped down in the power supply unit by an isolating transformer.

Protection against direct contact

Protection against coming into contact with live parts is essential (and stipulated) for both low and high voltages. This protection can take the form of

- insulation,
- covering devices or
- keeping at a safe distance.

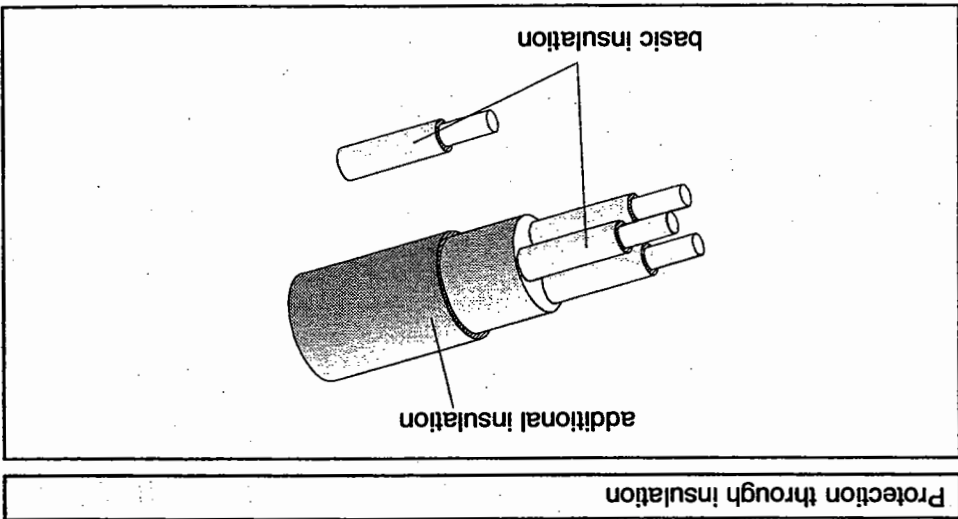
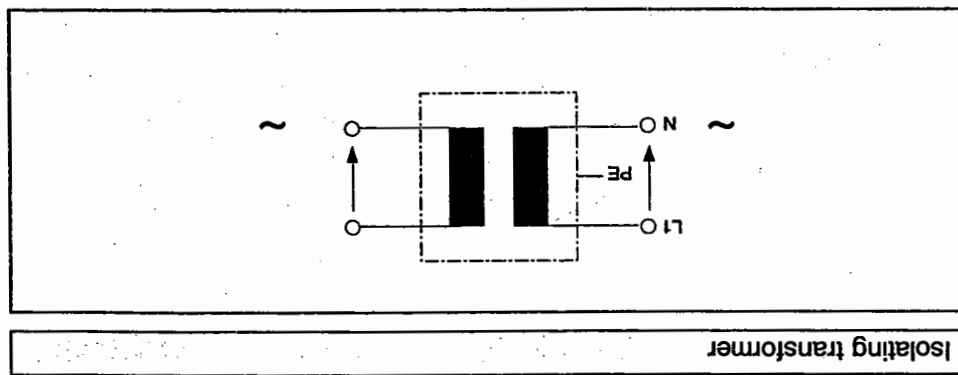

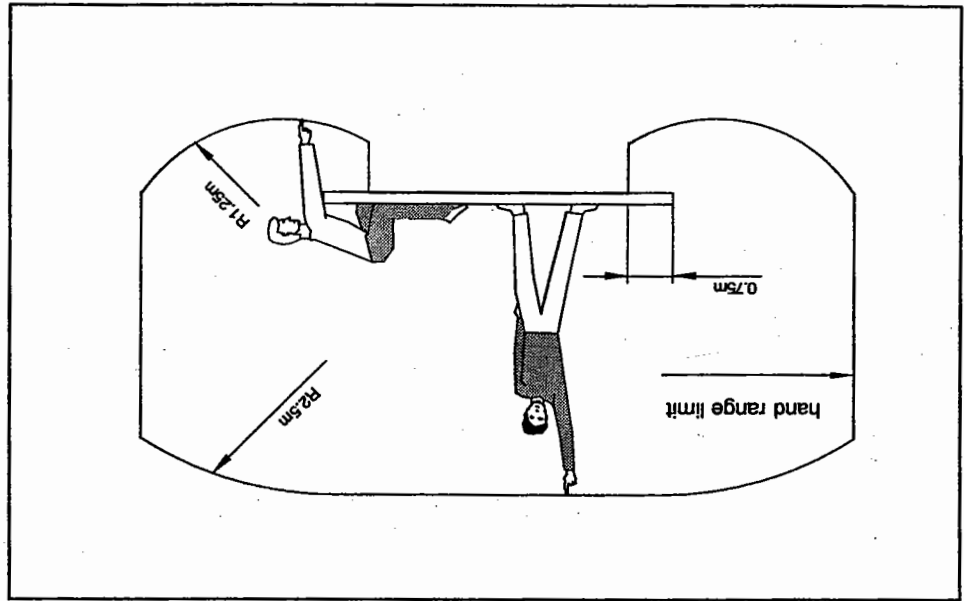

Protection through keeping a safe distance

- residual voltage operated circuit-breakers,
- residual current operated circuit-breakers,
- circuit-breakers,
- fusable links,

devices are used:

In contrast to the signal control section, the hydraulic assembly is generally operated at higher voltages. The measures for protection against direct contact also apply here. In addition, components situated in areas where they may be touched by personnel (e.g. housings) are earthed. If, for example, a housing becomes live, this leads to a short circuit and the upstream overload protection devices are activated. The layout of these circuits and the response characteristics of the overload protection devices can differ considerably. The following

Overload protection devices

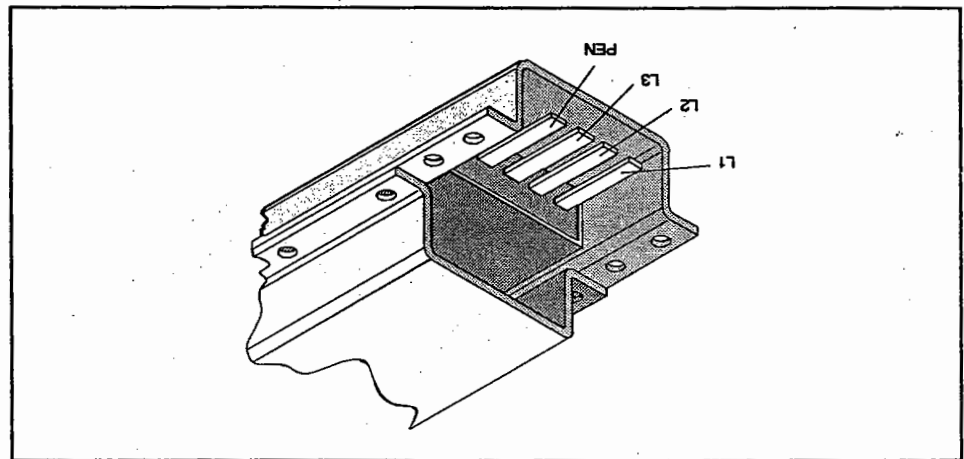

Protection through covers

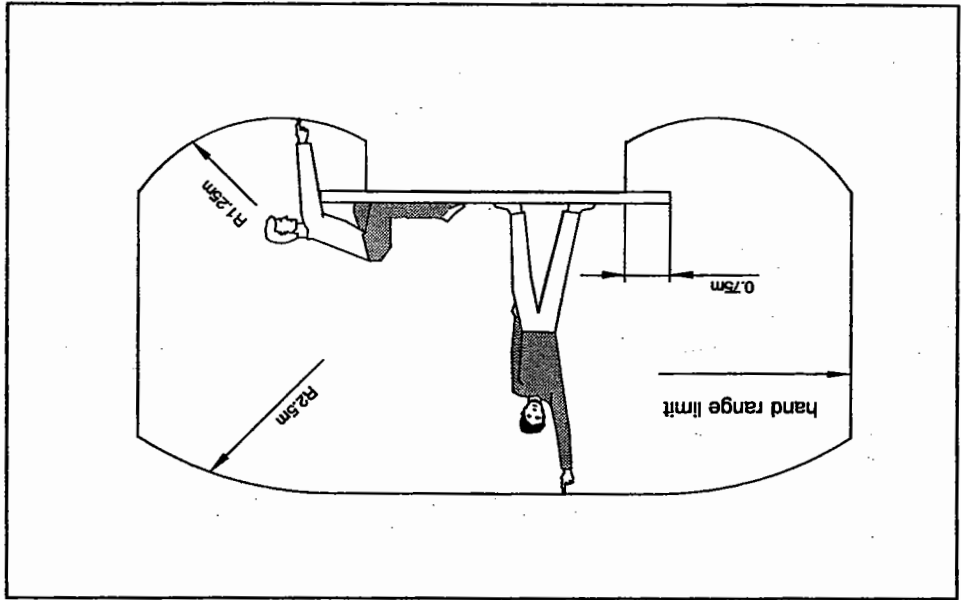

Protection through keeping a safe distance

- residual voltage operated circuit-breakers,
- residual current operated circuit-breakers,
- circuit-breakers,
- fusable links,

devices are used:

In contrast to the signal control section, the hydraulic assembly is generally operated at higher voltages. The measures for protection against direct contact also apply here. In addition, components situated in areas where they may be touched by personnel (e.g. housings) are earthed. If, for example, a housing becomes live, this leads to a short circuit and the upstream overload protection devices are activated. The layout of these circuits and the response characteristics of the overload protection devices can differ considerably. The following devices are used:

Overload protection devices

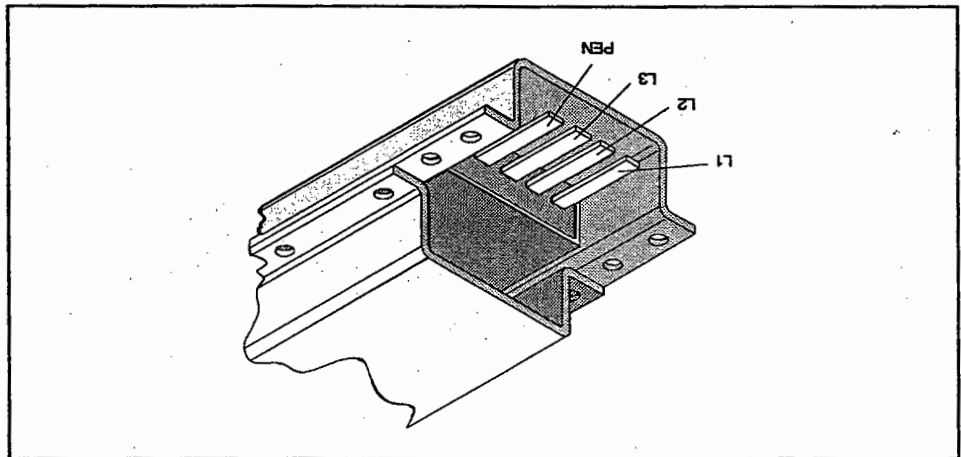

Protection through covers

EMERGENCY STOP switch

In the event of danger, it must be possible to shut down a machine immediately via an EMERGENCY STOP switch to separate all equipment from the mains supply. The following regulations apply to the EMERGENCY STOP circuit:

1. Necessary lighting must not be switched off using the EMERGENCY STOP function.
2. Clamped workpieces must not be released by actuation of the EMERGENCY STOP function.
3. Auxiliary and braking devices designed to perform functions such as rapid shutdown of the machine must not be rendered ineffective.
4. Return movements must be initiated by actuation of the EMERGENCY STOP function if this is necessary. They may, however, only be initiated if this does not pose a risk to personnel.
5. The identification colour of the EMERGENCY STOP switch is bright red; the area below the manual actuating element must be in the contrasting colour yellow.

Further requirements for the EMERGENCY STOP circuit in electrical and hydraulic systems are contained in DIN 31000.

Master switch

In addition, each machine must be equipped with a master switch via which the entire electrical equipment can be switched off for the duration of cleaning, maintenance and repair work and during lengthy down-times.

1. The master switch must be manually operated and may have only one Off and On position with stops identified by 0 and 1.
2. In the Off position it should be possible to lock the switch in such a way that manual and remote switch-on are prevented.
3. If there are several feed sources, it must be possible to interlock the master switches in such a way that there is no risk or danger.

Solutions

Part C



Exercise 1

Direct solenoid valve actuation

1. Hydraulic circuit diagram

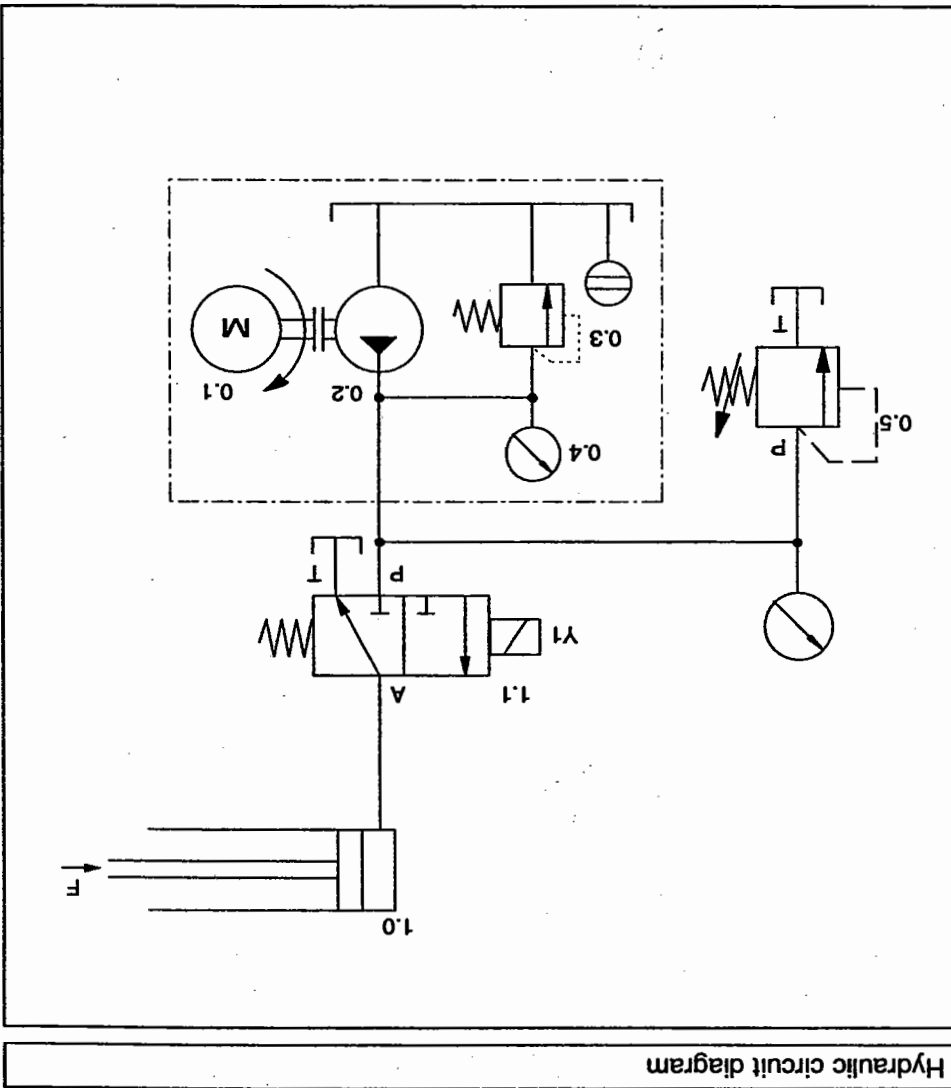

Electrical circuit diagram

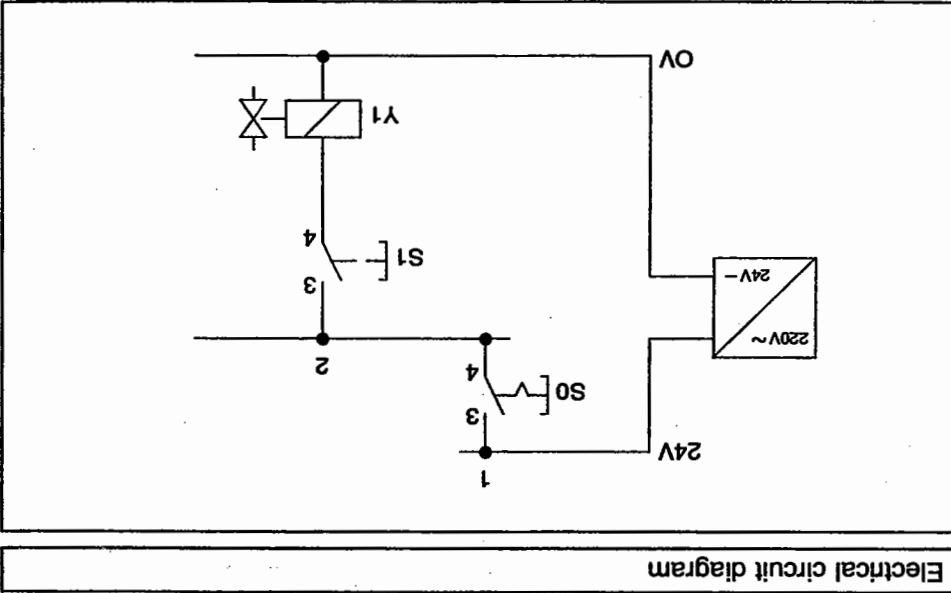

As the control operates via a direct voltage supply, the current carrying capacity for direct voltage (DC) is decisive. This means that push-buttons no. 2 and no. 3 could be used.

As can be seen from the electrical circuit diagram, a normally open contact is needed for this solution. As push-button no. 2 is not equipped with a normally open contact, push-button no. 3 is the only suitable device.

$$\frac{31 \text{ W}}{24 \text{ V}} = 1.3 \text{ A}$$

The power consumption of the solenoid valve is 3 W. At a voltage of 24 V, the contacts must be able to cope with a load of at least

contact rating:	normally closed contact:	normally open contact:
250 V AC : 4 A 220 V/110 V AC 1.5/2.5 A 12 V DC 0.2 A	1	1
5 A/48 V AC 4 A/30 V DC	3	2
	2	3

2. Selection of the push-button

- If control switch S1 is actuated when the master switch is on, current flows through the solenoid coil. The electromagnet energises, the directional control valve switches over, and the piston rod of the cylinder advances.
- If the push-button is released, current no longer flows through the solenoid coil. The coil is de-energised and the directional control valve switches back, and the piston rod of the cylinder retracts due to the weight load.

Function description



Exercise 2

Indirect solenoid valve
actuation

1. Hydraulic circuit diagram

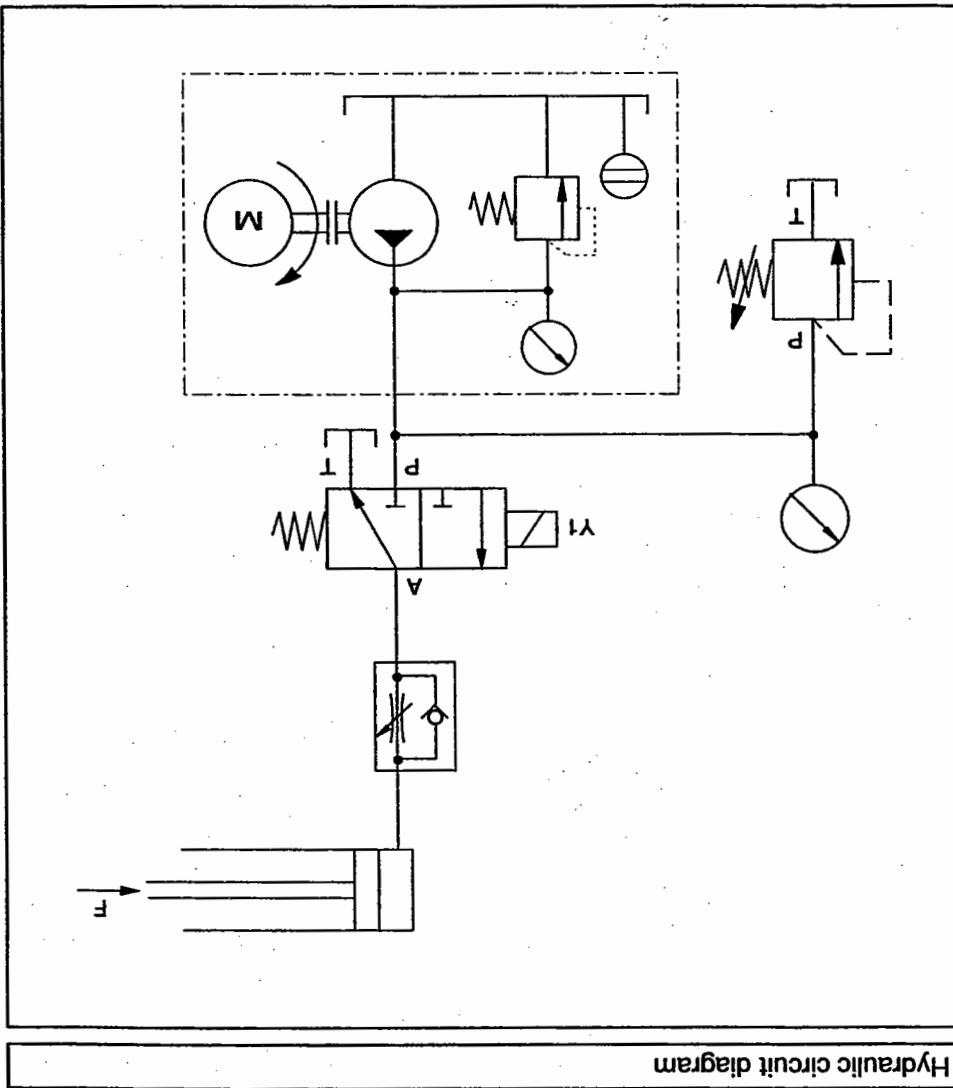

Hydraulic circuit diagram

A one-way flow control valve is fitted to throttle the return stroke speed. It is advisable to install the throttle valve as close as possible to the cylinder, as this prevents oscillation of the piston and thus of the straightening roller. The directional control valve is also a throttle point, although the extent of throttling can be ignored, since the cross section of the directional control valve orifice is considerably greater than that of the one-way flow control valve.

Electrical circuit diagram, indirect actuation

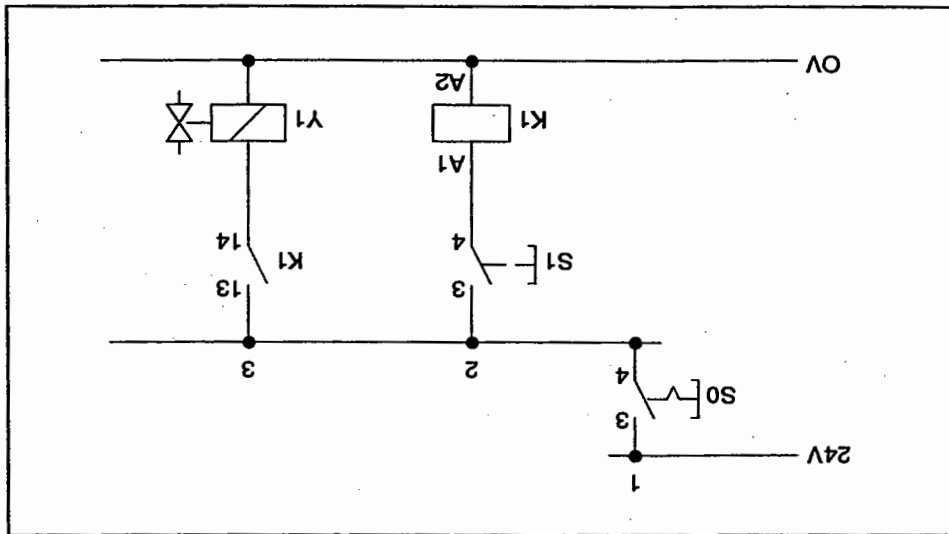

- Current path 2 is the control circuit in the signal control section. The control circuit contains push-button S1 (normally open contact) and relay K1.
- Current path 3 is the interface to the power control section and is the main circuit (energy circuit).
- Master switch S0 is assigned to both circuits.

If master switch S0 is already switched on and push-button S1 is pressed, relay K1 in current path 2 switches and the contact of K1 in current path 3 is closed. Solenoid coil Y1 of the 3/2-way solenoid valve switches and the piston rod of the cylinder advances.

If the push-button is released, the magnetic field of relay K1 decays. Contact K1 opens again. There is no longer voltage at the solenoid valve. The spring returns the valve to the normal position. The piston rod retracts due to the weight of the roller.

Function description

Exercise 3

Boolean basic logic functions

1. Signal reversal, hydraulic

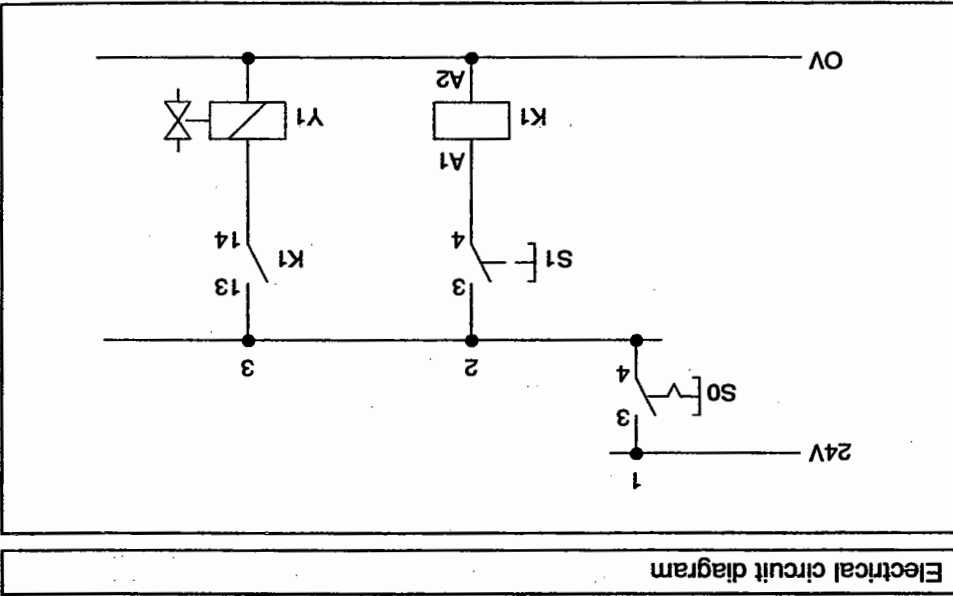
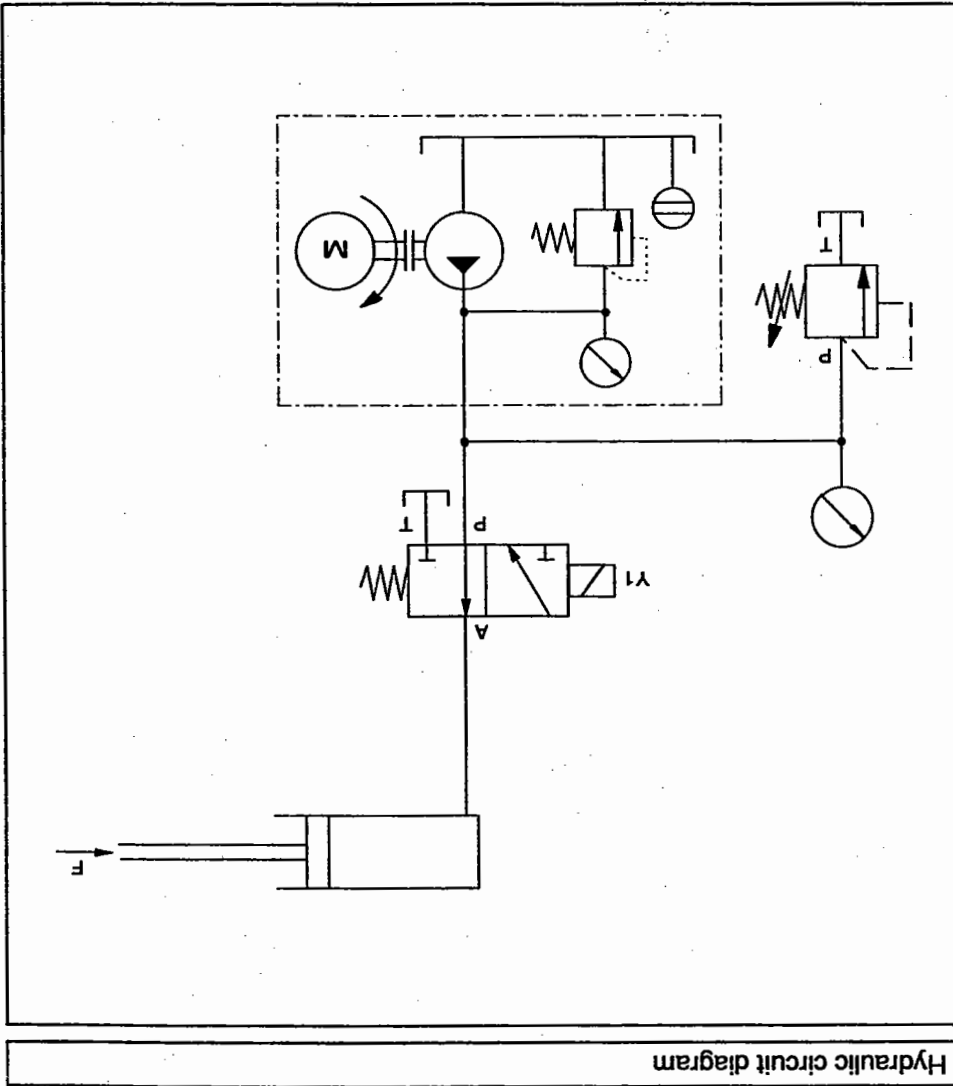

- Function description
- In this circuit an unactuated push-button means: the relay coil does not energise, the normally open contact in the main circuit remains open, and the valve is not actuated. Reversal of the signal is achieved using a valve with switching positions which are the exact opposite of those in the valve in the preceding task definition (throughflow in normal position instead of blocked in normal position). This means that the cylinder chamber is supplied with pressure when the valve is not actuated and that the piston rod advances when the hydraulic power supply is switched on.
 - When the push-button is pressed, the valve is supplied with current via the relay and switches over. The piston rod retracts.

The hydraulic circuit diagram is to be drawn in a position where the hydraulic assembly is switched on, but where the electrical power supply to the signal control section is switched off. As signal reversal is to be performed hydraulically, a valve with throughflow in the normal position is to be selected. In this position, this valve connects the cylinder chamber to the pressure circuit. The piston rod of the cylinder is therefore to be drawn in the advanced position.

2. Signal reversal, electrical

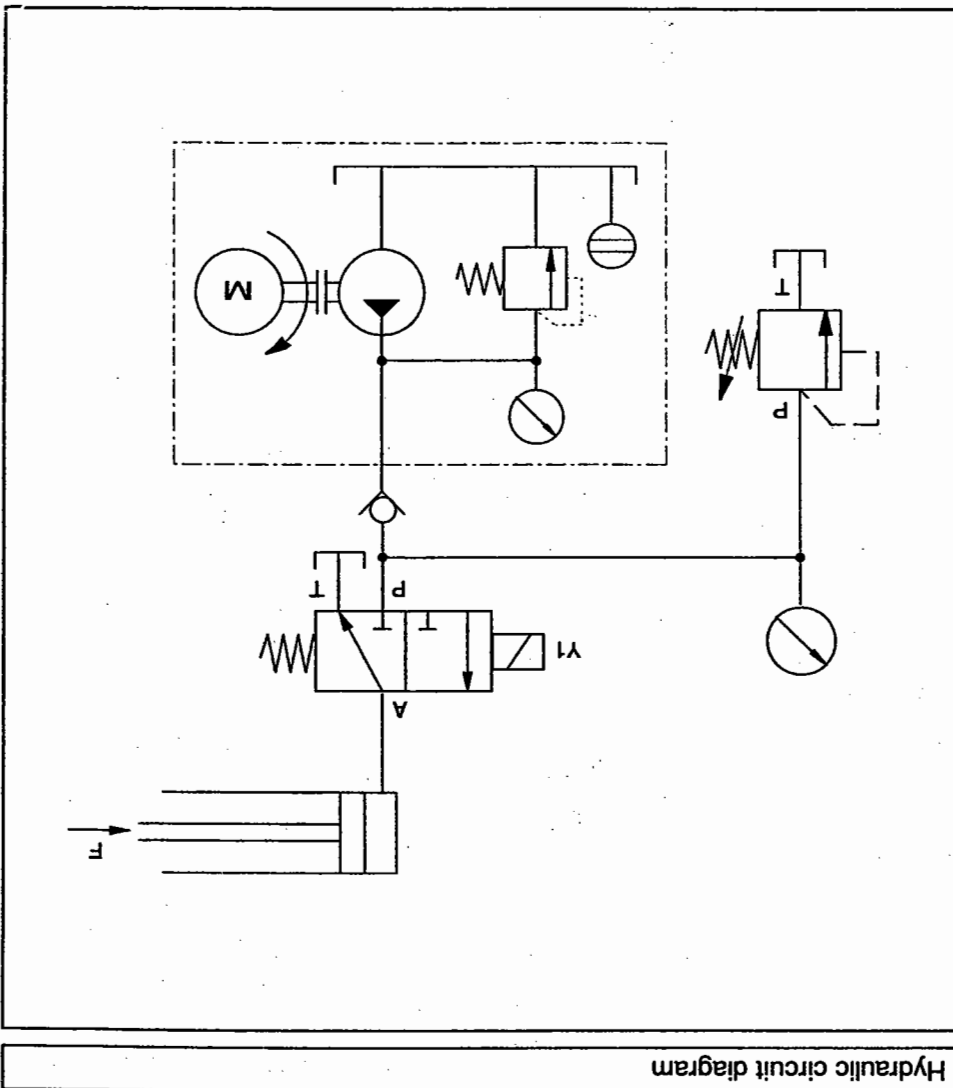

Hydraulic circuit diagram

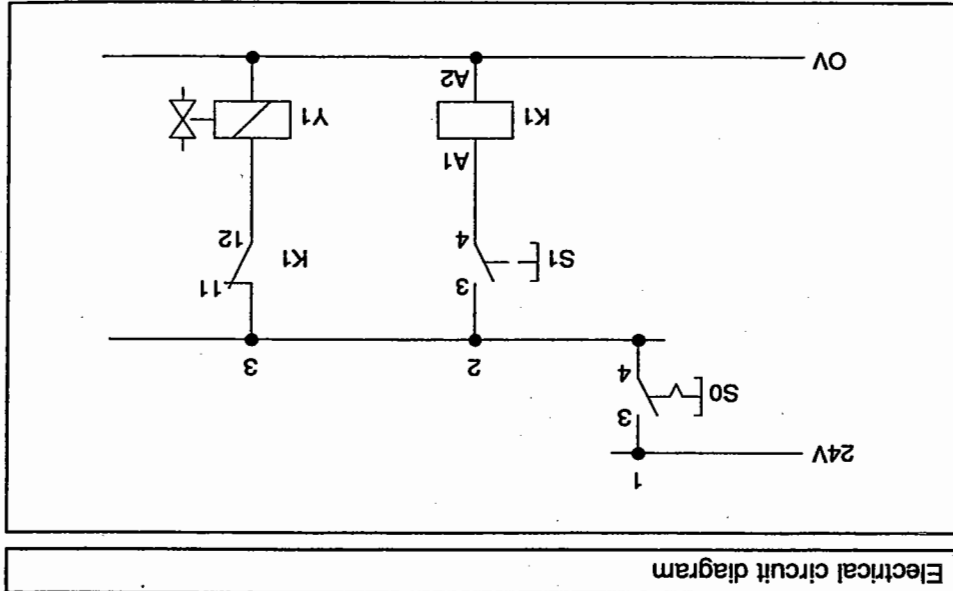

Electrical circuit diagram

As previously, the hydraulic circuit diagram is to be drawn in a position where the electrical power supply is switched off. The valve is therefore not actuated. The cylinder chamber is connected to the tank; as a result, there is no pressure and thus no force acting on the piston. Accordingly, the piston rod is pushed back into the cylinder by external force. It must therefore be drawn in the retracted position.

- As long as push-button S1 is not actuated, no current flows through relay coil K1 in the control circuit. The normally closed contact in the control circuit is therefore closed. Current flows through the solenoid and the valve is in the actuated position. The piston rod advances or remains in the advanced position.
- If push-button S1 is pressed, relay K1 in the control circuit energises. The normally closed contact of K1 interrupts the main circuit. The signal in the main circuit is reversed compared to the signal in the control circuit. The solenoid coil is de-energised, the valve switches back to the non-actuated position, and the piston rod retracts.

Function description

Exercise 4

Signal reversal

1. Signal reversal, electrical

Hydraulic circuit diagram

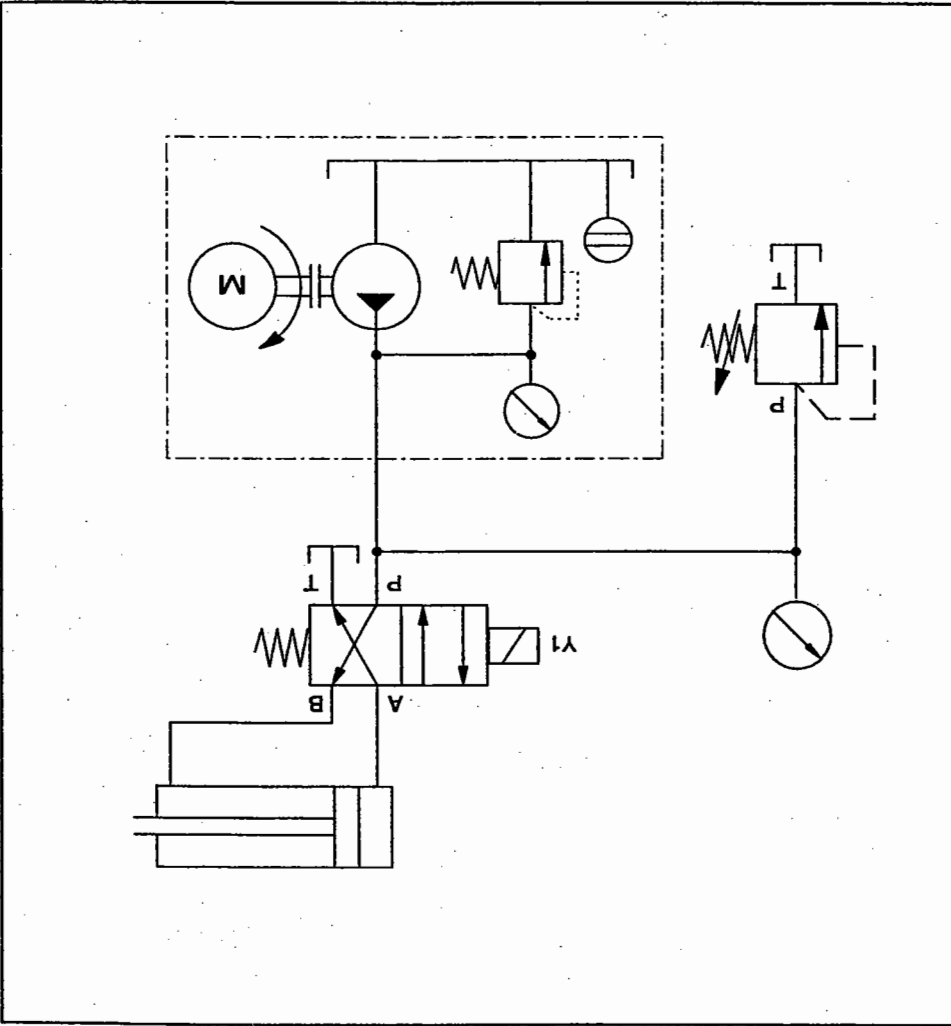

Electrical circuit diagram

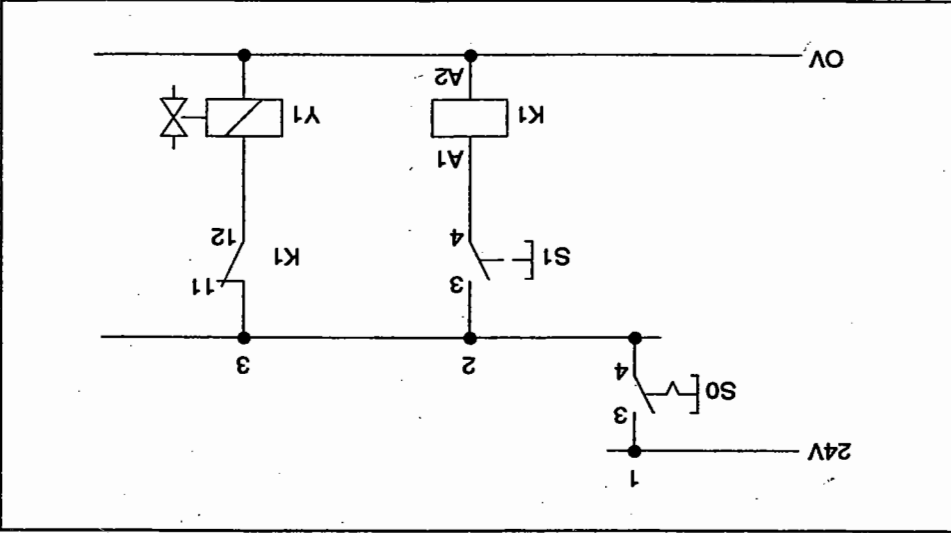

The signal control section fulfills the same functions as the section described in Exercise 3 and is therefore of identical design.

As the signal in the hydraulic circuit is not reversed, the valve should be connected in such a way that the piston rod advances in the actuated position. If the die cushioning cylinder of the press is pushed back, the oil in this circuit also flows against the pumping direction in the circuit (see Exercise 3). If the flow rate is too high, the oil cannot be directed away via the pressure relief valve. In this event, a check valve must be installed to protect the assembly, as was the case in Exercise 3.



2. Signal reversal, hydraulic

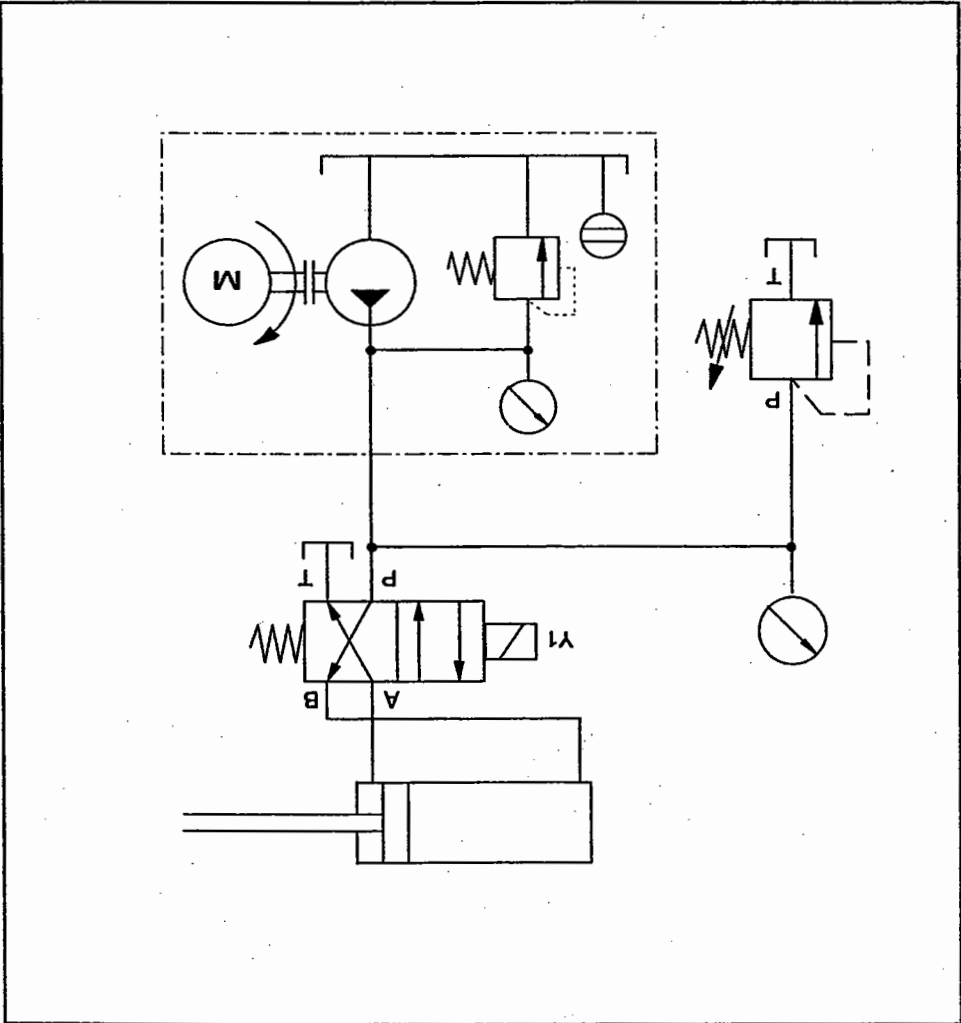

Hydraulic circuit diagram

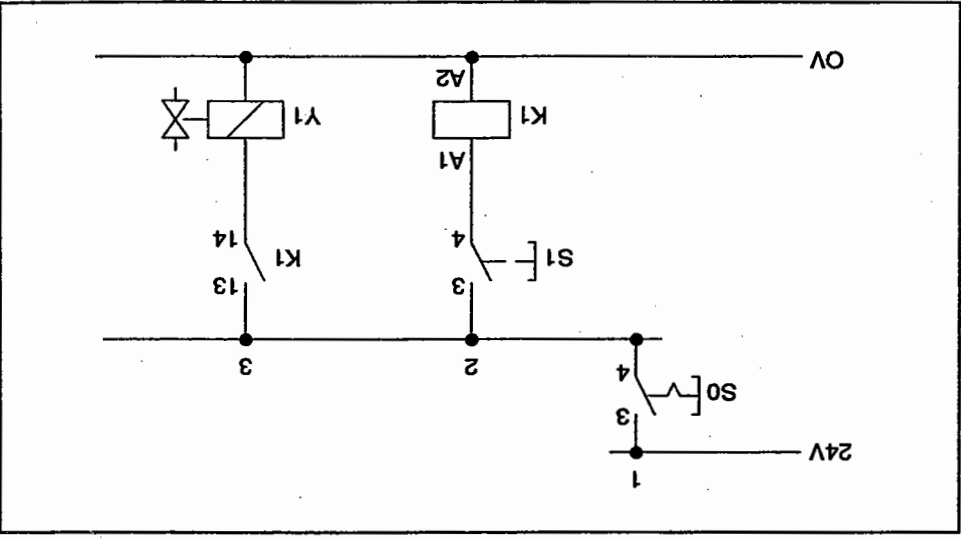

Electrical circuit diagram

As the signal in this circuit is hydraulically reversed, the valve should be connected in such a way that the piston rod retracts when the valve is actuated.

For the remainder, the same remarks apply as for electrical signal reversal.

Although the two circuits react in the same way under normal circumstances, they react in different ways to a failure of the supply voltage to the signal control section:

- the piston rod retracts with electrical signal reversal,
- and the piston rod advances with hydraulic signal reversal.

3. Failure of the supply voltage to the signal control section

Exercise 5

Conjunction and negation

1. Hydraulic circuit diagram

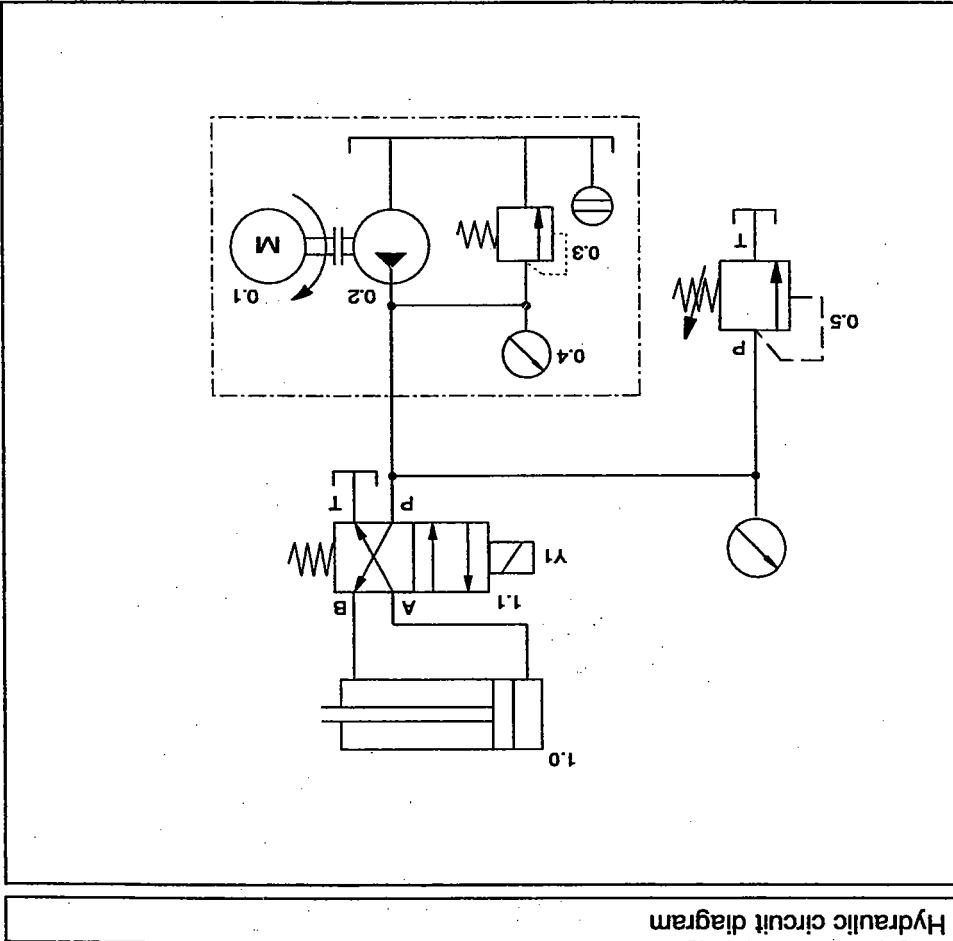

Parts list

Item Qty	Description	Type and Standard designation	Manufacturer/Supplier	No. Alteration				Make	Signed	Date	Purchaser	Group	Sheet	of	Drawing no.	Sample parts list of a hydraulic system	Inventory no.	Type	Tested
				No.	Date	Name													
1	Electric motor											03	4	4					
1	Hydraulic pump																		
1	Safety pressure relief valve																		
1	System pressure relief valve																		
1	Pressure gauge																		
1	Hydr. cylinder, double-acting																		
1	4/2-way solenoid valve																		

2. Parts list

3. Truth table and logic circuit symbol

S1	S2	K1
0	0	0
0	1	0
1	0	0
1	1	1

truth table

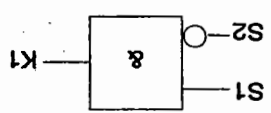

logic symbol

The mould may close only if push-button S1 is pressed and limit switch S2 is not actuated. Signal K1 may therefore only be set under this condition.

4. Electrical circuit diagram

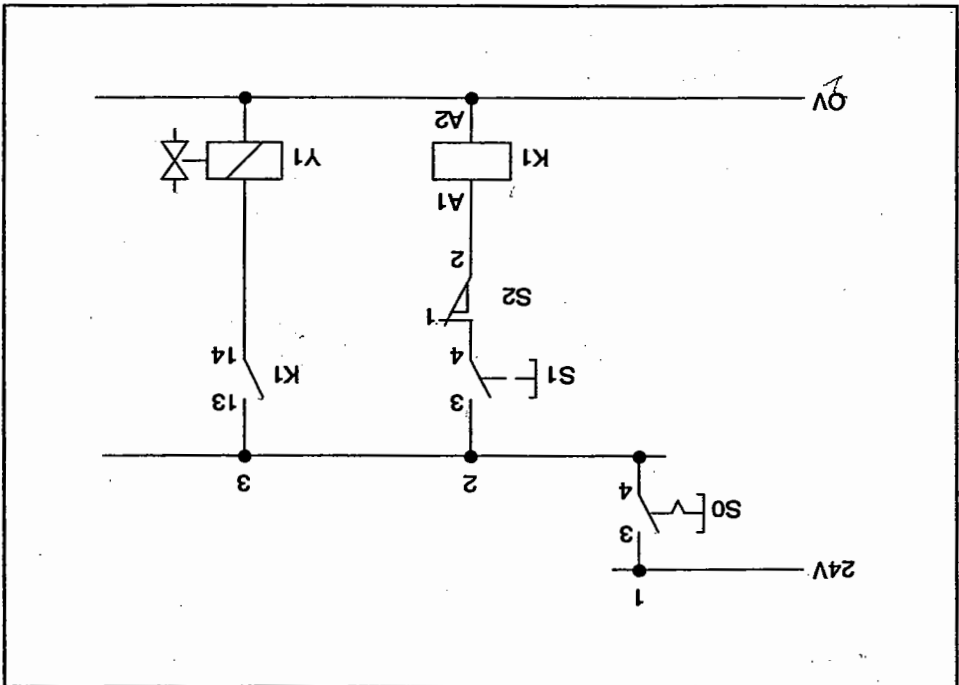

To ensure reversal of signal S2, limit switch S2 is to be connected as a normally closed contact.

Exercise 6

Disjunction

1. Hydraulic circuit diagram

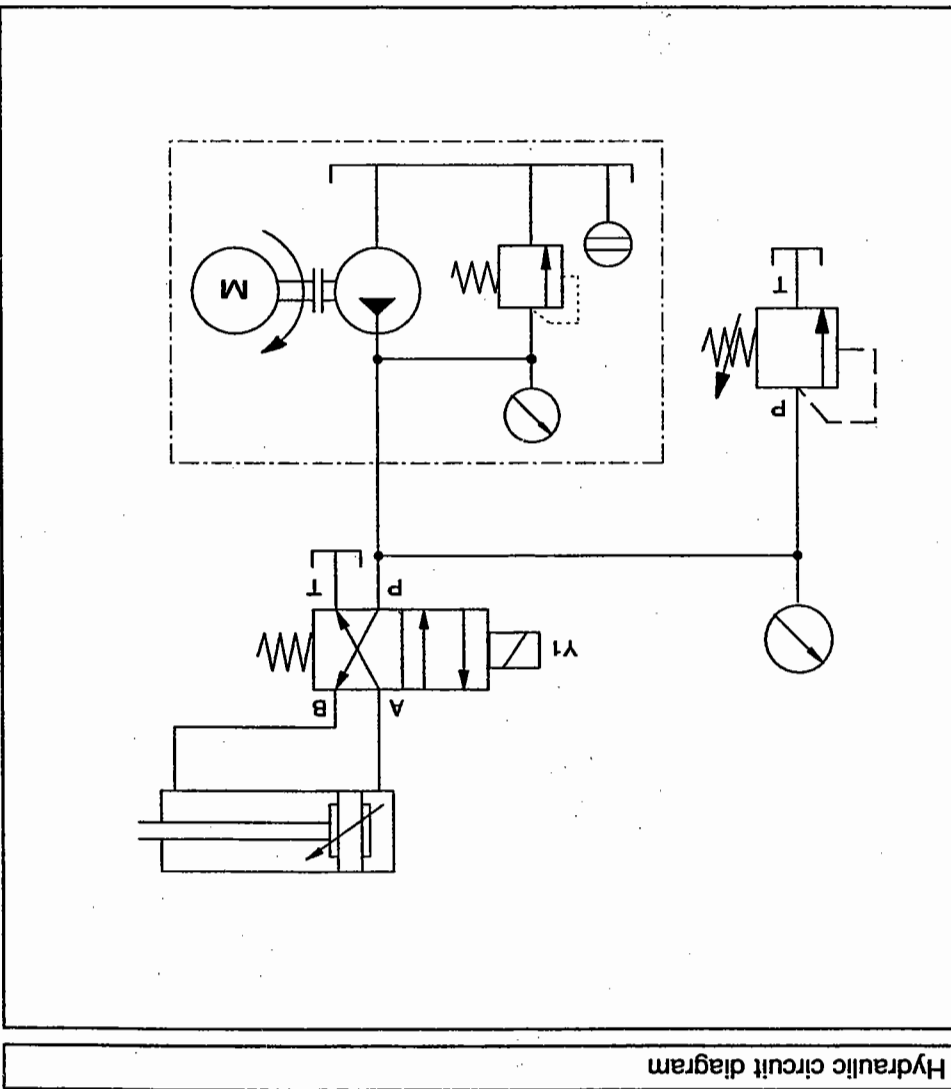

In both circuits the valve coil Y1 energises if either manual push-button S1, foot-operated button S2 or both buttons are pressed.

The second circuit has the advantage that push-button S1 only acts on coil K1, and push-button S2 only on coil K2. This makes it possible to realise additional functions:

- further contacts of K1 can be used to switch the current paths which are designed to react only to the manual push-button (e.g. warning light for manual push-button);
- further contacts of K2, on the other hand, switch the current paths which are supposed to react only in dependence on S2 (e.g. warning light for foot-operated button).

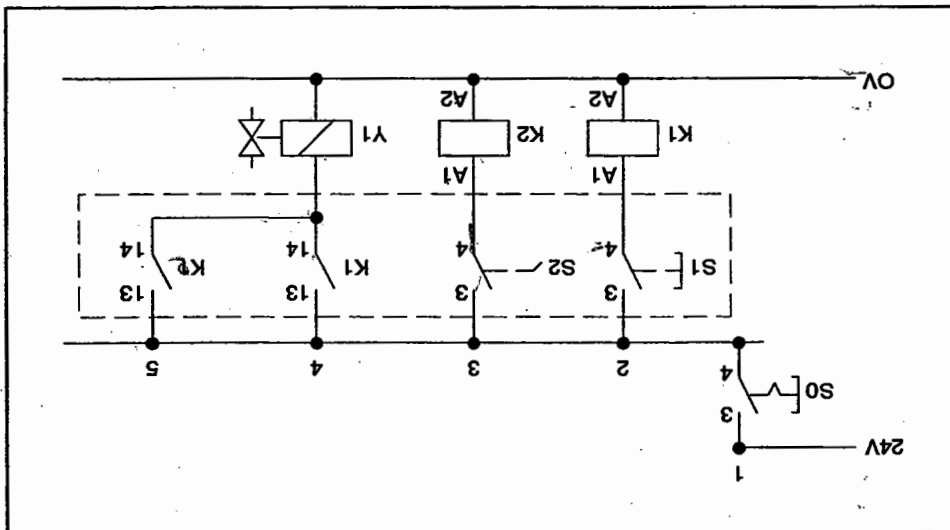

Circuit 2

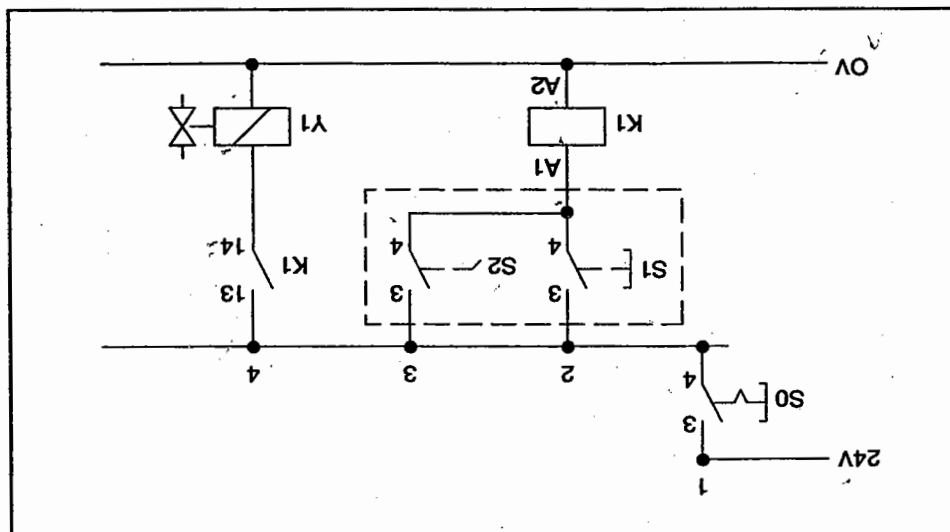

Circuit 1

2. Electrical circuit diagrams

Exercise 7

Assembly line

1. Hydraulic circuit diagram

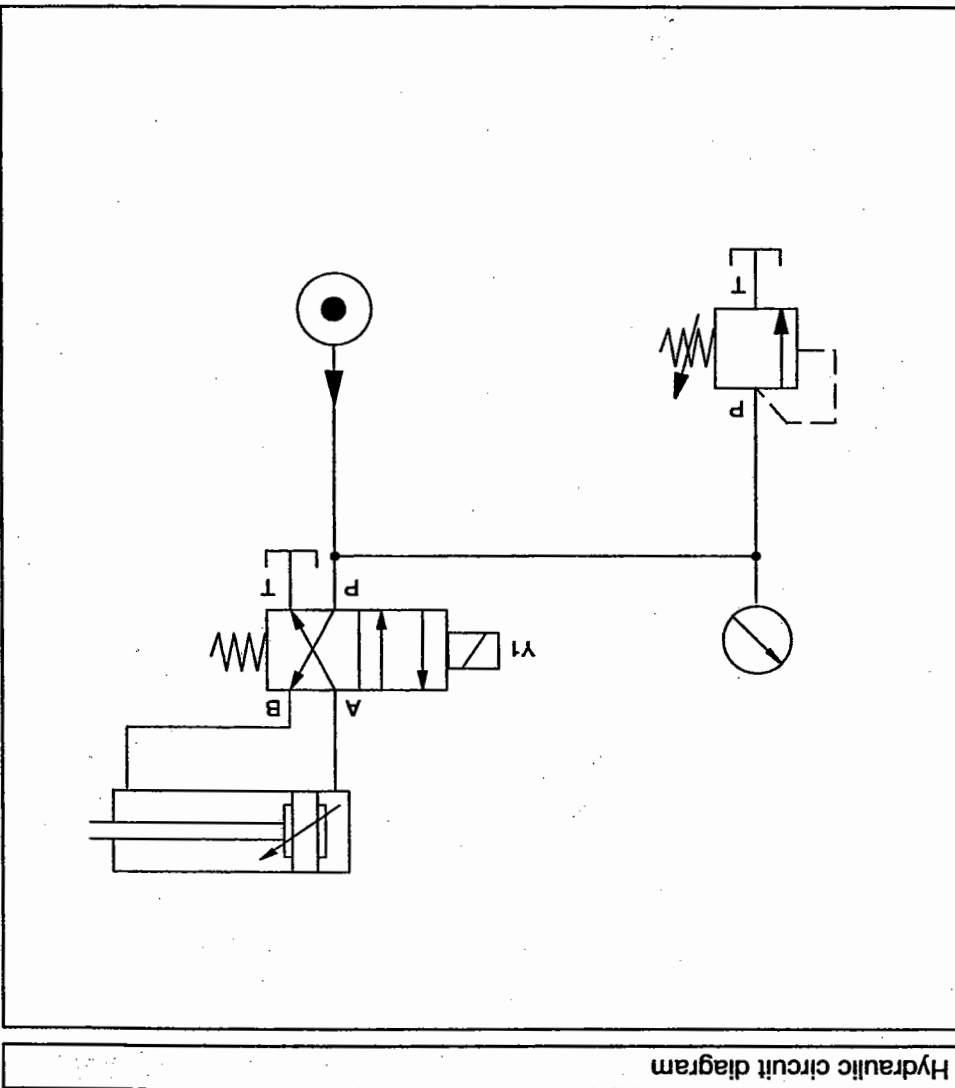

Hydraulic circuit diagram

Solenoid valve coil Y1 may be installed in current path 4 in place of relay K3. Relay K3 and current path 6 are then no longer necessary.

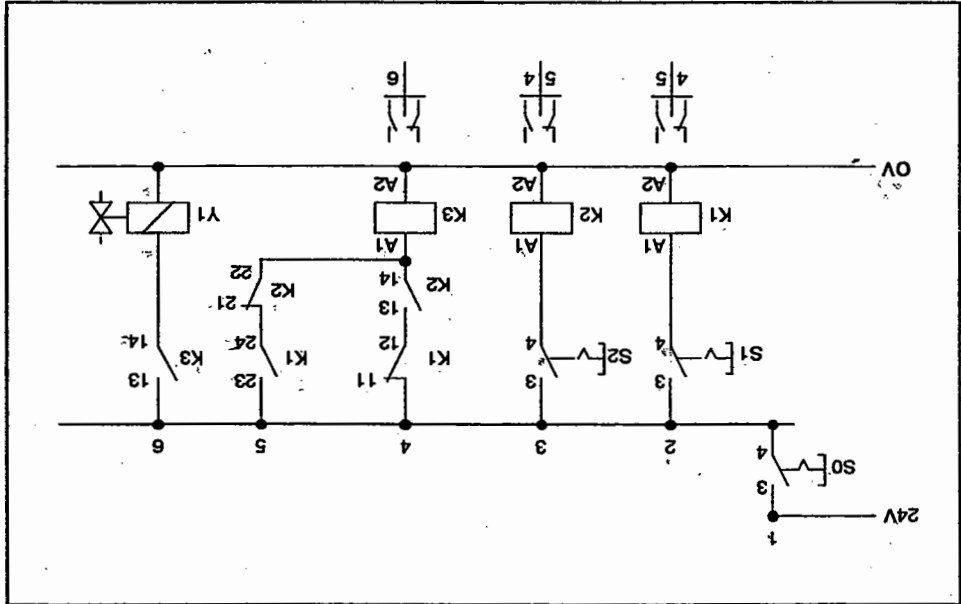

Electrical circuit diagram, two control switches with normally open contacts

3. Electrical circuit diagram, two-way circuit with normally open contacts

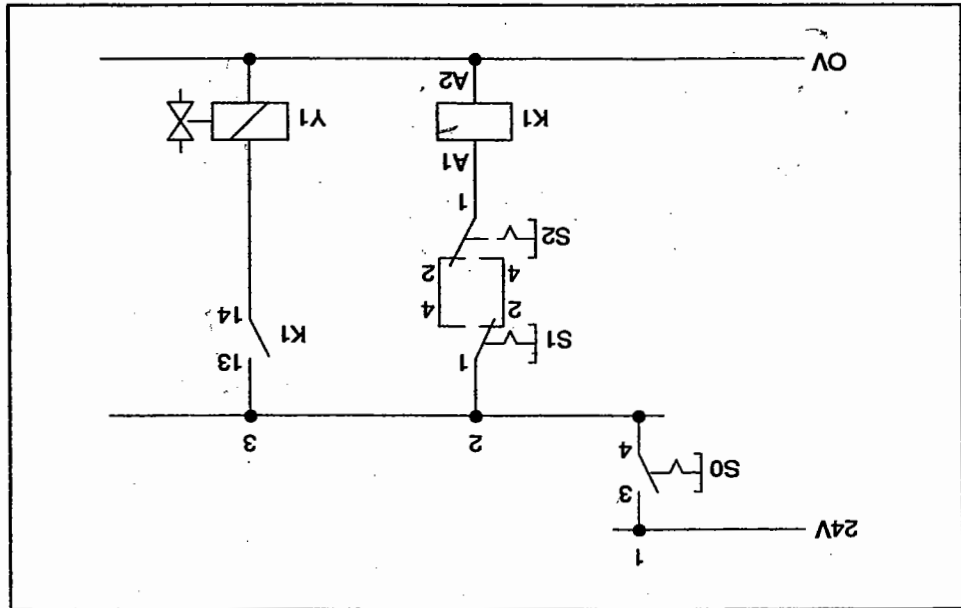

Electrical circuit diagram, two control switches with changeover contacts

2. Electrical circuit diagram, two-way circuit with changeover contacts

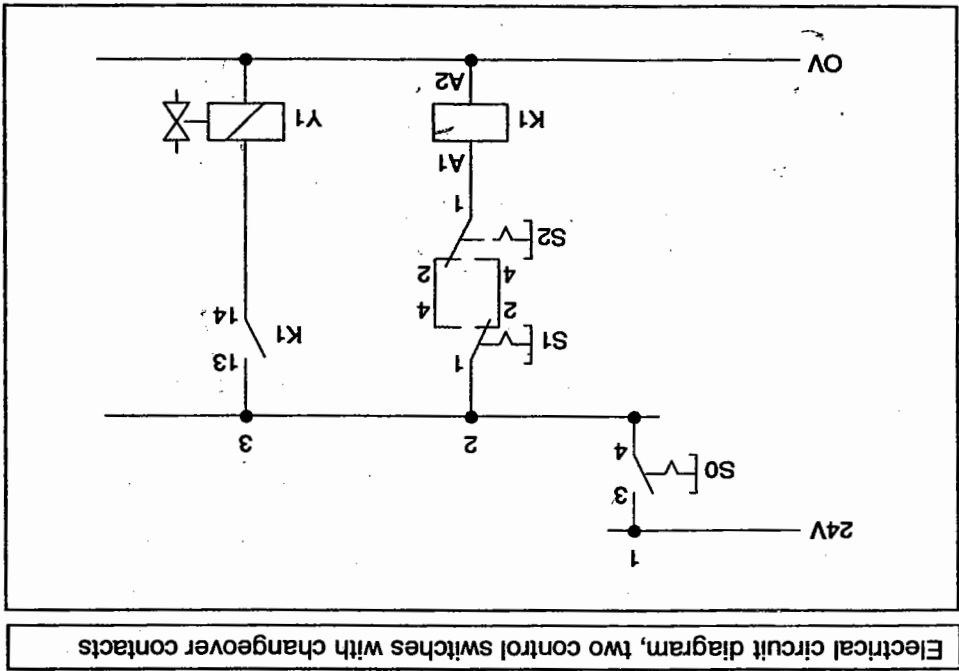

2. Electrical circuit diagram, two-way circuit with changeover contacts

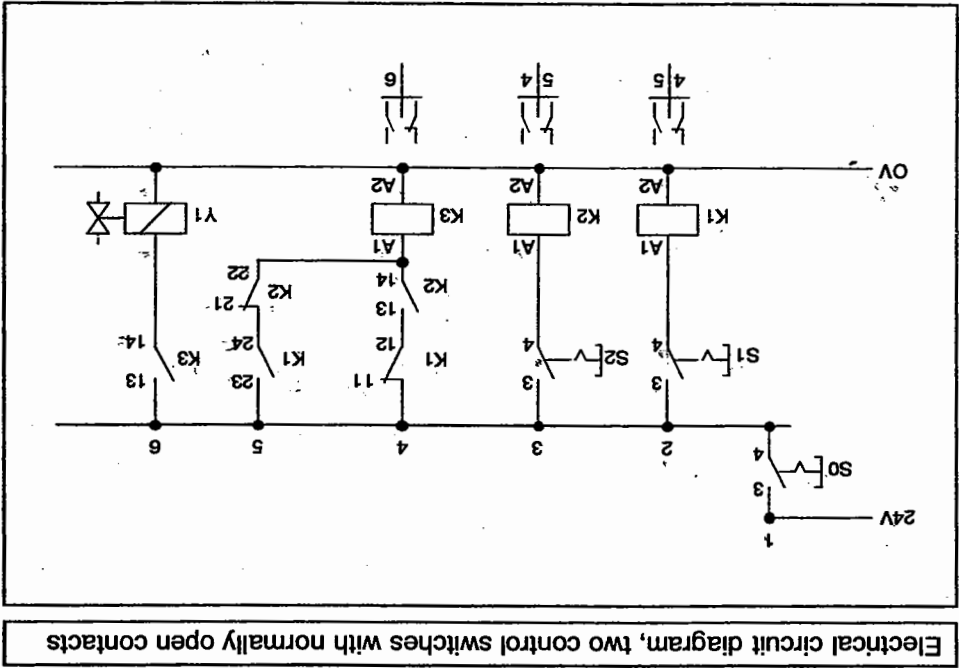

3. Electrical circuit diagram, two-way circuit with normally open contacts

Solenoid valve coil Y1 may be installed in current path 4 in place of relay K3. Relay K3 and current path 6 are then no longer necessary.

Exercise 8

Clamping device

1. Hydraulic circuit diagram

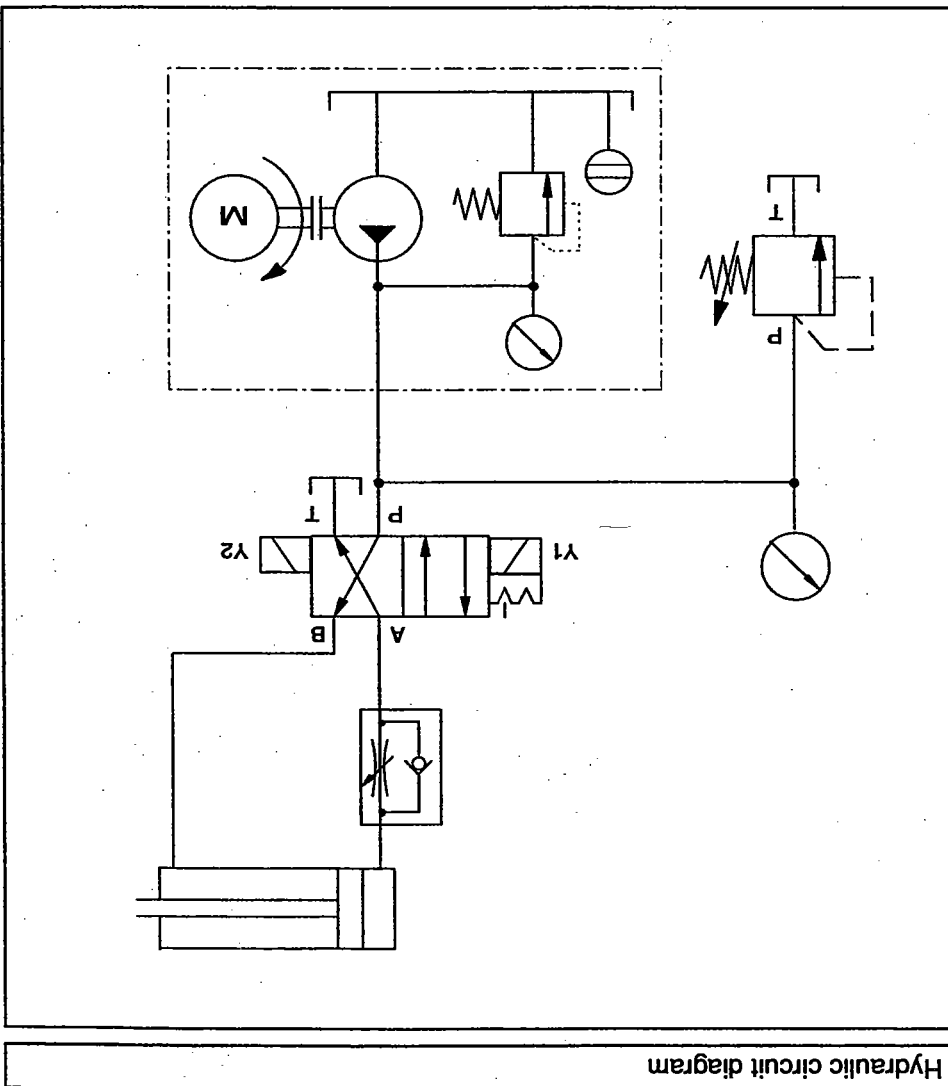

- Speed throttling only takes place during advance of the piston rod. During retraction, the throttle is bridged by the non-return valve. The one-way flow control valve can be installed in two places:
 - either as shown in the above circuit diagram,
 - or in the line between valve B and the cylinder chamber on the piston rod side.

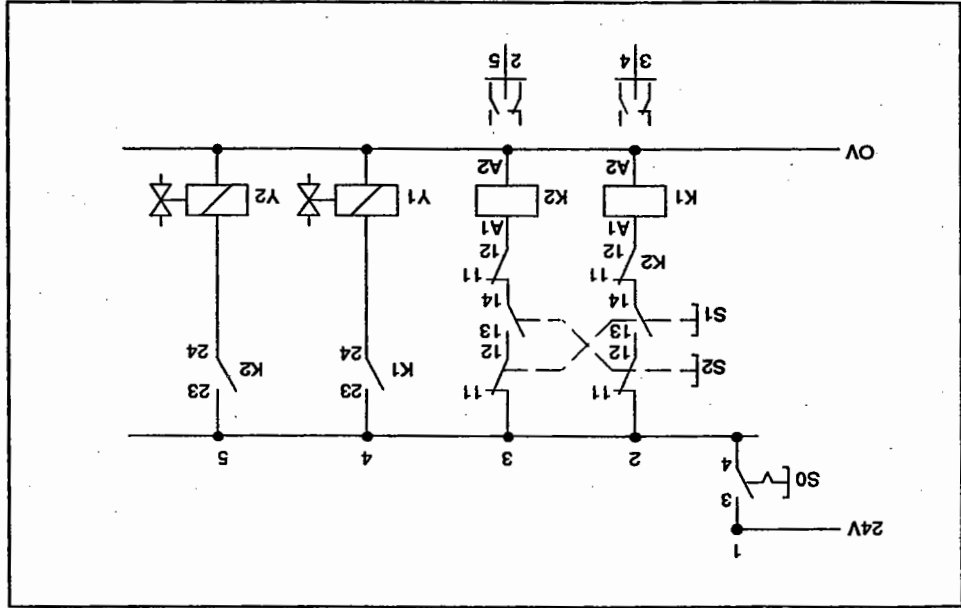

Electrical circuit diagram

2. Electrical circuit diagram

- Pressing push-button S1 energises relay K1. The piston rod advances.
- If push-button S2 is pressed, relay K2 energises. The piston rod retracts.
- If both push-buttons are pressed one after the other, the relay which was switched first de-energises, but the other relay is not switched. Both relays are thus in the de-energised state, and the double solenoid valve remains in the switching position it adopted first.

Function description

Exercise 9

Clamping device with latching

1. Hydraulic circuit diagram

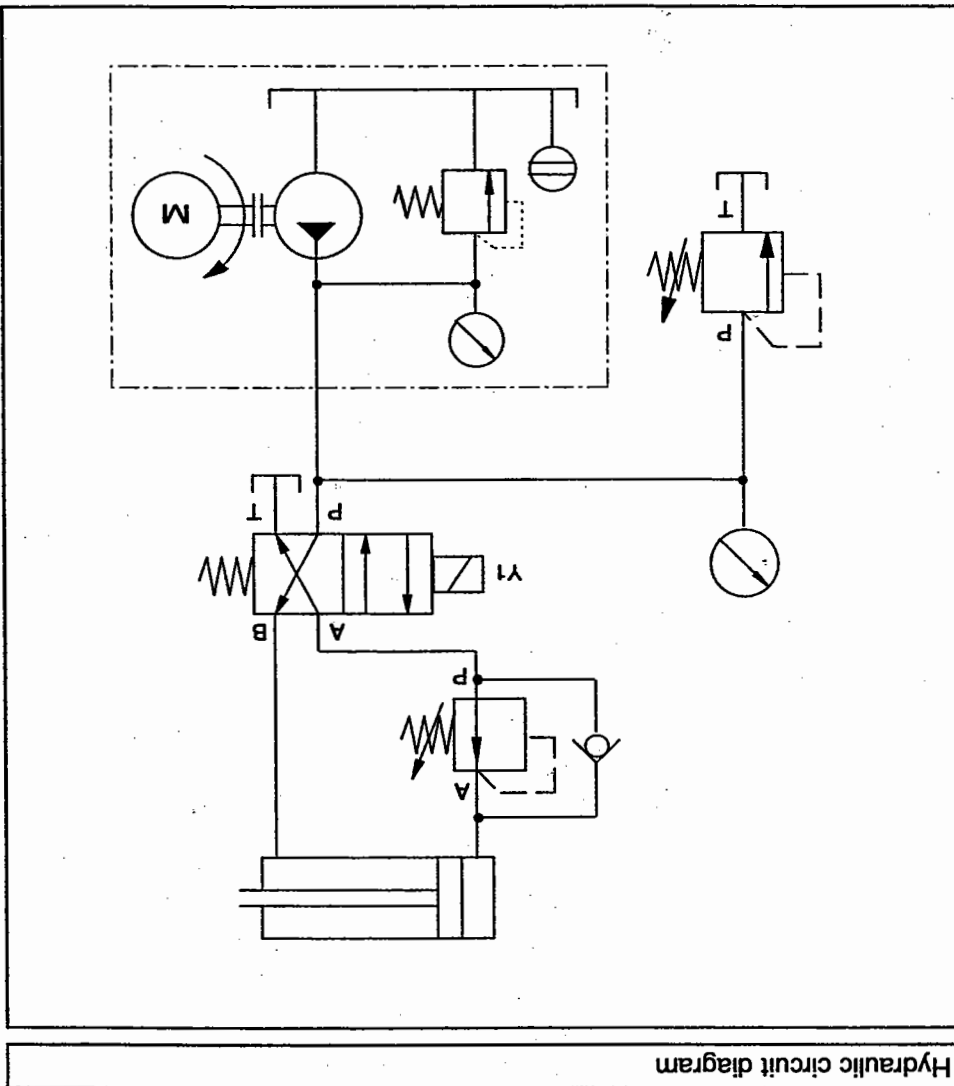

The pressure relief valve can be installed either between directional control valve and cylinder (see illustration) or between assembly and directional control valve.

- If the pressure regulator is between assembly and directional control valve, a non-return valve is not required. With this circuit design, it should be noted that the pressure is also reduced during the return stroke. The force of the retracting cylinder is therefore less than in the first circuit arrangement.
- If the pressure regulator is between directional control valve and cylinder, a non-return valve must be parallel-connected to allow retraction of the piston rod. During the retraction motion, the annular piston surface is subjected to the full system pressure.

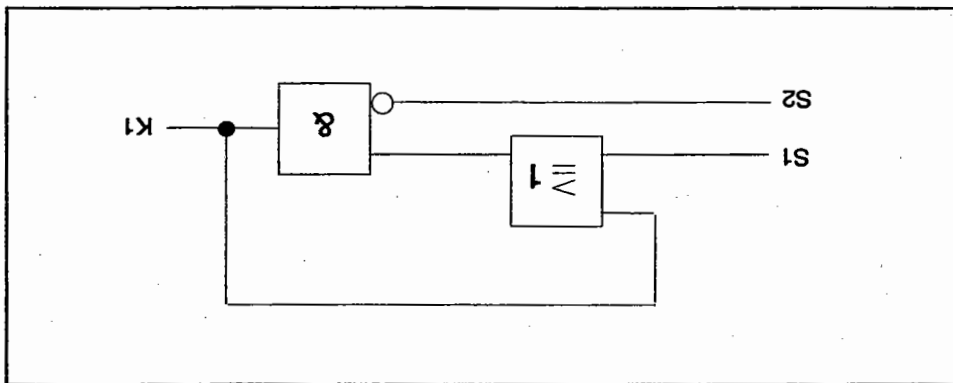

3. Logic diagram

Logic diagram

- Latching is set by pressing push-button S1; the valve switches to the actuated position. The piston rod advances.
- Pressing push-button S2 releases latching and the valve switches to the non-actuated position. The piston rod retracts.
- If both push-buttons (S1 and S2) are pressed, the output receives no signal – and latching is not set.

Function description

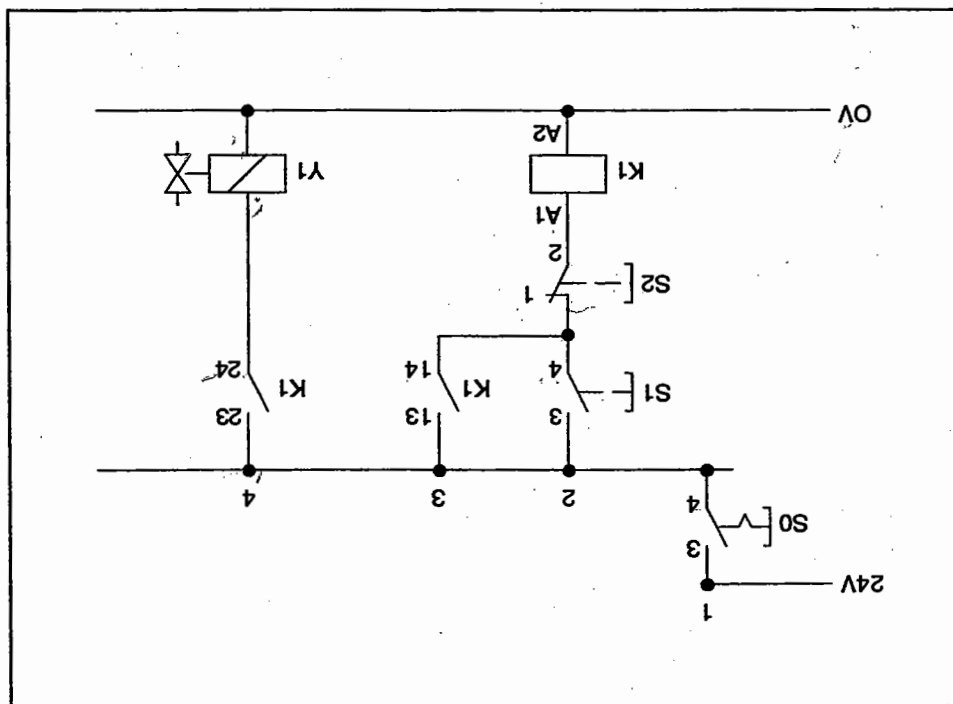

2. Electrical circuit diagram, dominant resetting latching circuit

Electrical circuit diagram

Exercise 10

Remaining device

1. Hydraulic circuit diagram

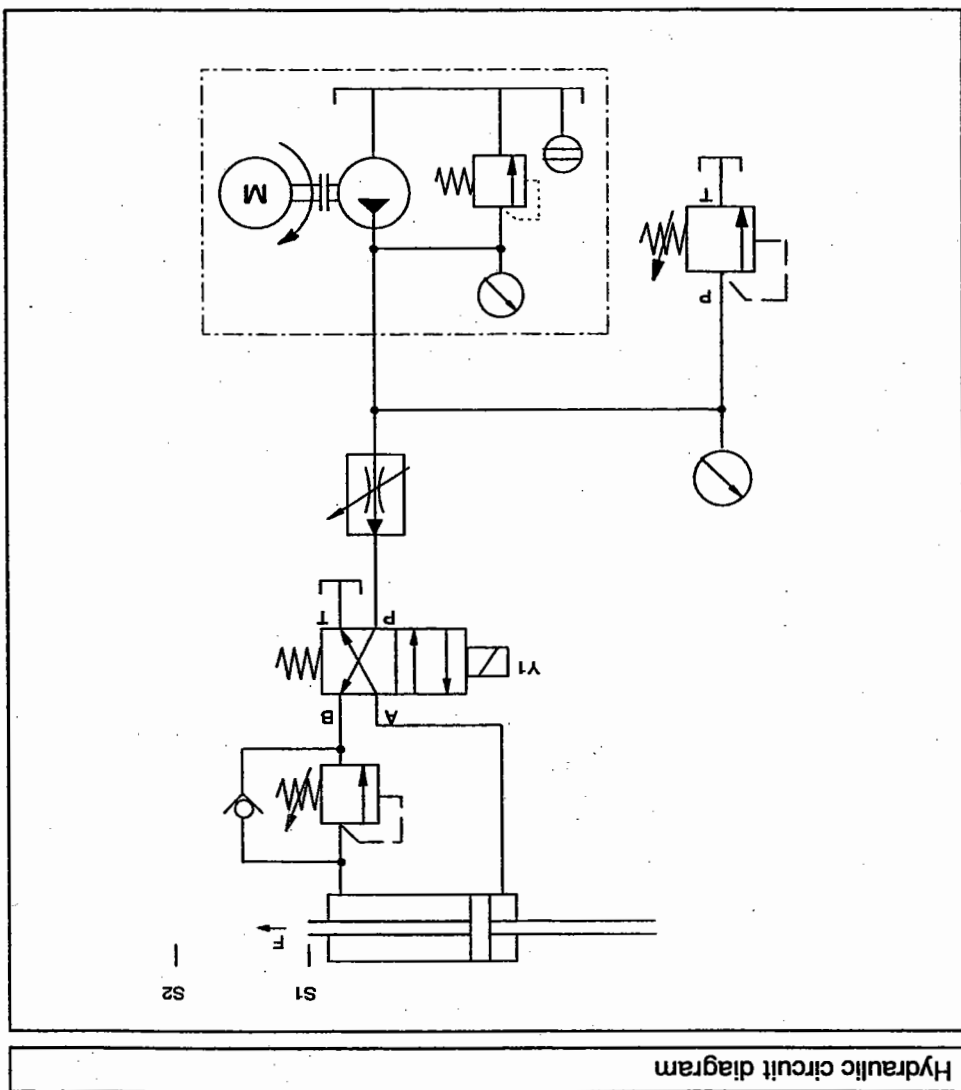

In this exercise, the machining speed is to be precisely maintained even under varying loads. This requires the use of a flow regulator.

The flow regulator regulates the flow in one flow direction only. To render it effective for both directions, it must be installed between directional control valve and hydraulic assembly.

The back-pressure valve is bridged by a non-return valve during the return stroke.

To allow generation of the latching function, limit switch S2 is connected as a normally closed contact. Limit switch S1 is connected as a normally open contact. An actuated normally open contact is shown in the circuit diagram as a normally closed contact with an arrow. In addition, the contacts are identified by numbers according to standard. This provides a further indication of how the limit switch is connected.

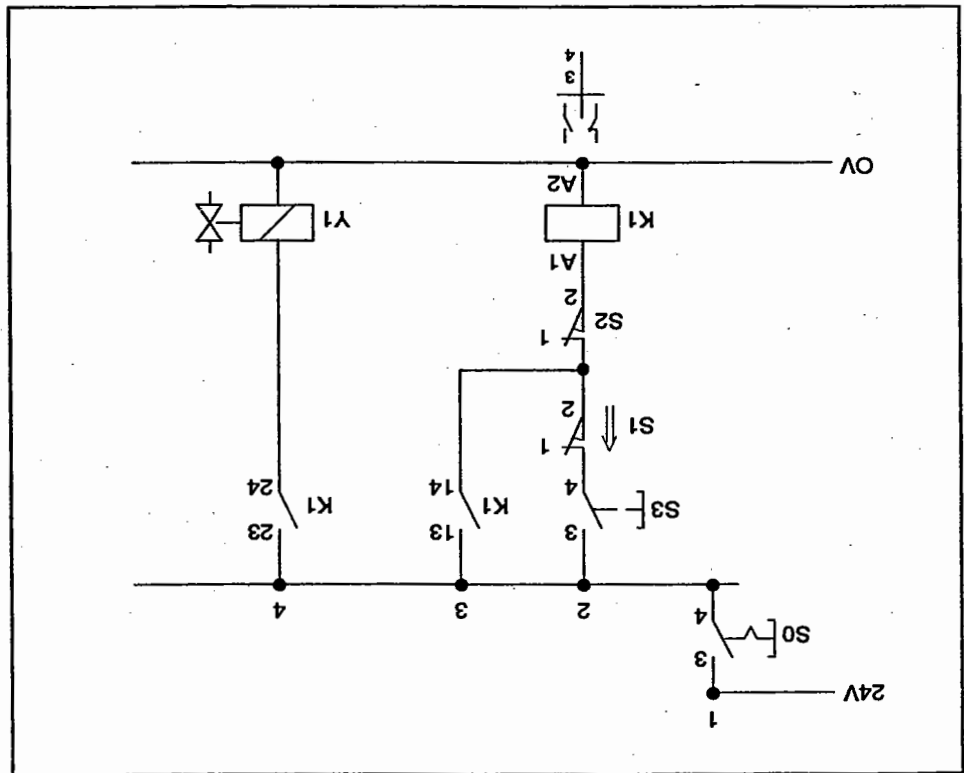

Electrical circuit diagram

2. Electrical circuit diagram

Exercise 11

Pressing device

1. Function diagram for the hydraulic press

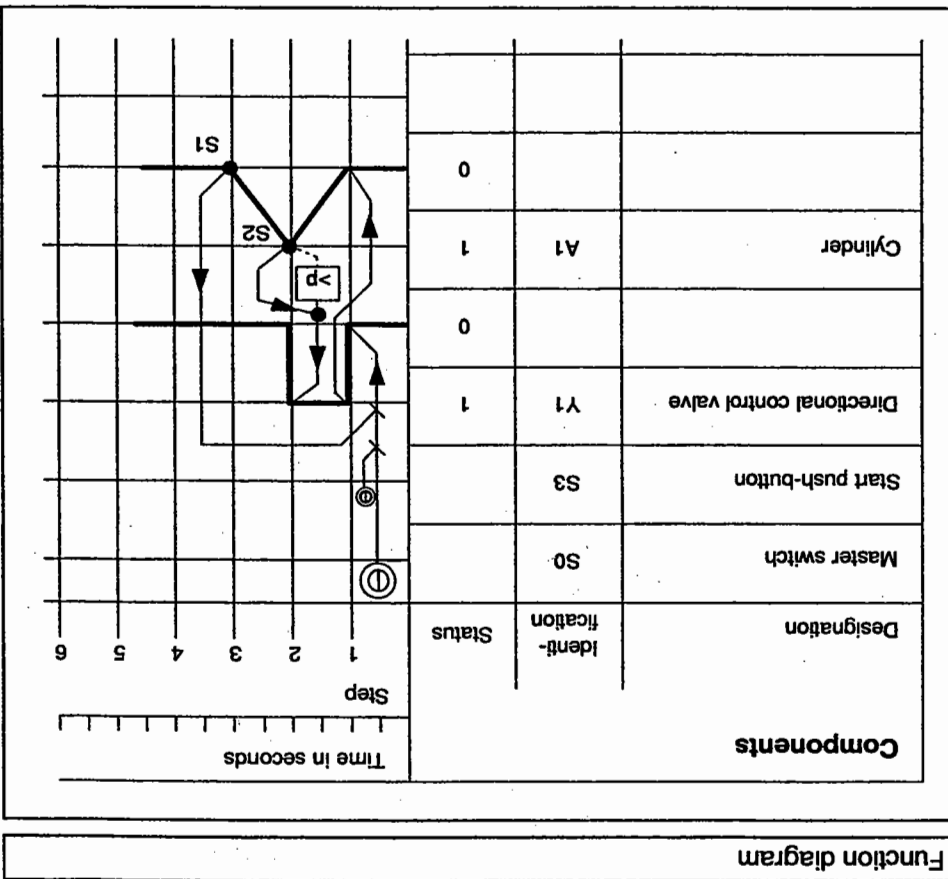

- **Step 1:**
The directional control valve is switched into the actuated position when the following conditions are met:
 - the master switch is switched on,
 - the piston rod is in the retracted position
 - and the start push-button is pressed.
- **Step 2:**
If the actual pressure exceeds the set limit pressure, or if the piston rod reaches the forward end position, the valve is reversed. The piston rod retracts.
- **End of cycle:**
The cycle is complete when the piston rod reaches the retracted end position.

The pressure switch must be installed for adjustment of the pressure switch and cylinder. Pressure gauges are to be installed for adjustment of the pressure switch and the counter-pressure valve.

The maximum pressure is 60 bar, and thus far lower than with outflow throttling. The hydraulic components need only be designed for operation with pressures up to 60 bar.

If 20 bar is set at the counter-pressure valve, only 10 bar (not taking into account the friction in the cylinder) are needed to overcome this resistance on the piston side on account of the surface ratio.

3. Maximum pressure
4. Adjustment of the pressure switch

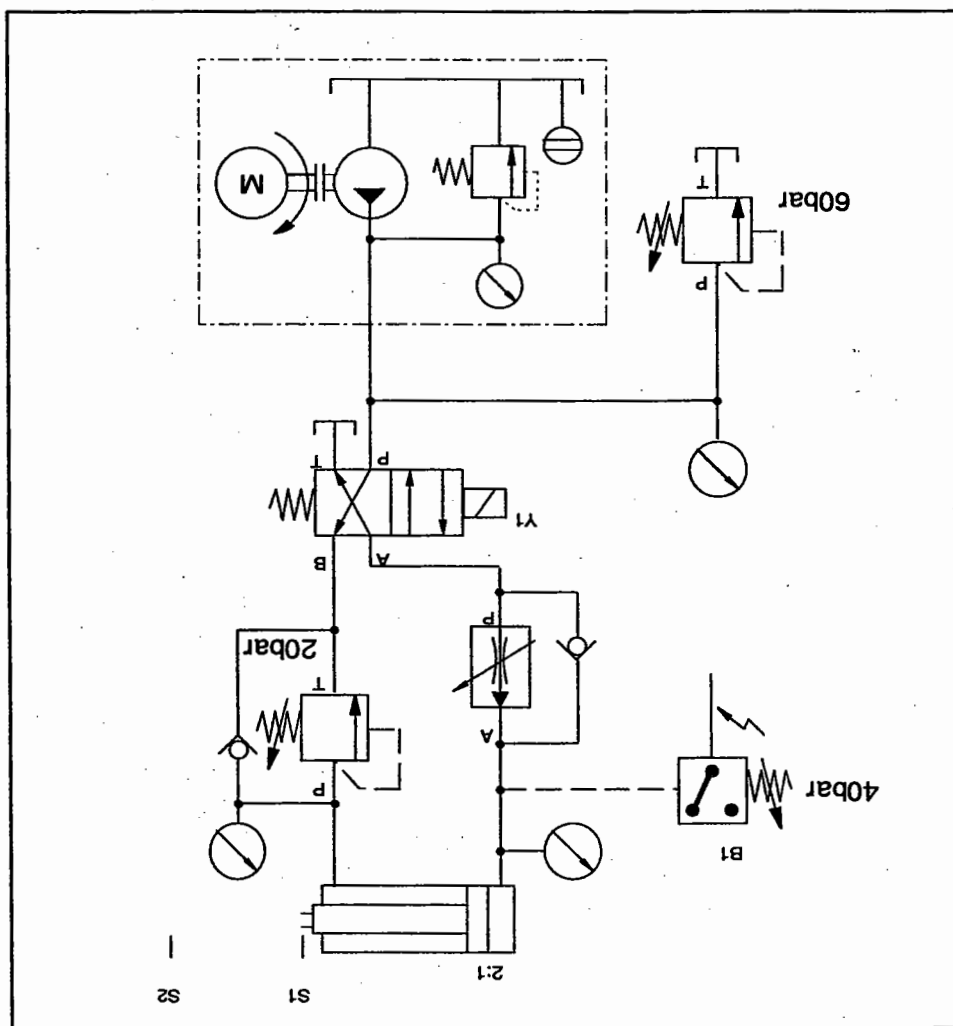

Hydraulic circuit diagram

2. Hydraulic circuit diagram

The following pressure is additionally required for pressing operations:

$$F_p = \frac{6000 \text{ N}}{\pi \cdot (25 \text{ mm})^2} = 3.06 \frac{\text{N}}{\text{mm}^2} = 30.6 \text{ bar}$$

The pressure switch should therefore be set to:

$$10 \text{ bar} + 30.6 \text{ bar} = 40.6 \text{ bar} \approx 40 \text{ bar}$$

5. Electrical circuit diagram

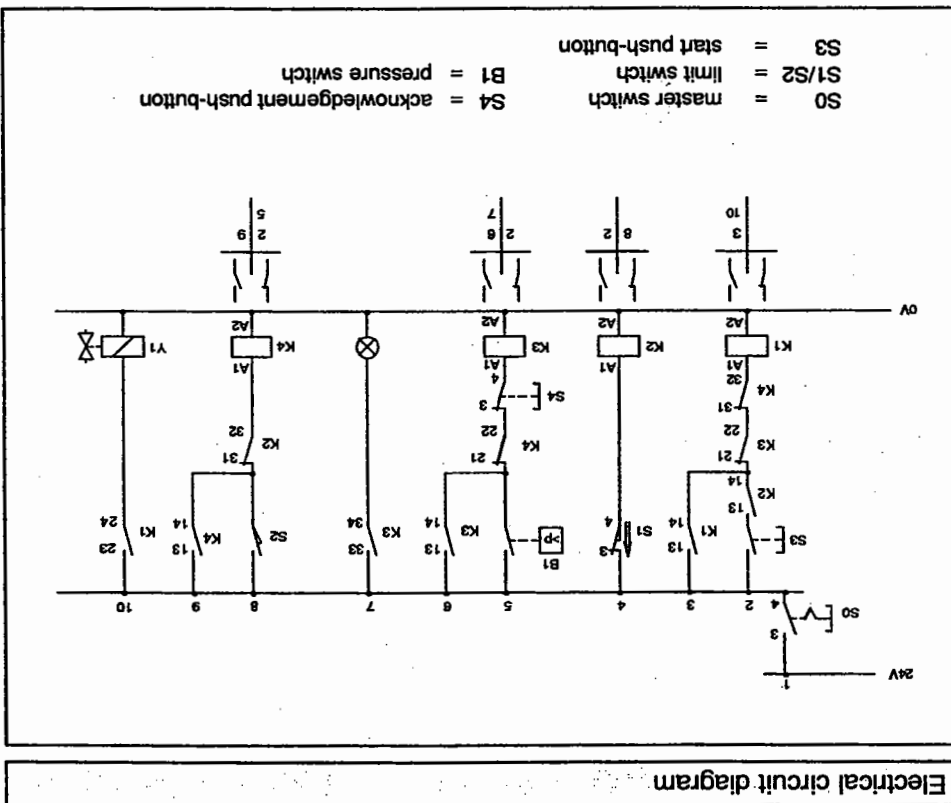

Relay positions:

K1 energised: directional control valve is switched, piston rod advances
 K2 energised: piston in retracted end position
 K3 energised: overpressure
 K4 energised: piston rod retracts

A further contact of K2 is located in current path 2. This means that the pressing process cannot begin until the piston rod is retracted – only then are the start conditions fulfilled.

The actual pressure should not exceed the maximum pressure during retraction of the piston rod. The pressure switch must therefore be rendered inoperative during retraction. To this end, the contact of K4 blocks current path 5 until the piston rod is in its starting position. Limit switch S1 is actuated and relay K2 releases the latching of K4.

Malfunction:
If the pressure exceeds 40 bar when the piston rod advances, pressure switch B1 switches relay K3 to latching. The first contact of K3 releases the latching of relay K1 in current path 2. The piston rod retracts. The second contact closes current path 7, and the optical indicator lights up. Acknowledgement push-button S4 releases the latching of relay K3. The light goes out and start-up can be effected.

Normal movement:
When start push-button S3 is pressed, the piston rod advances up to limit switch S2. K4 energises and reverts to latching. The normally closed contact of K4 in current path 2 releases the latching of relay K1.

6. Function description

Exercise 12

Milling machine

1. Hydraulic circuit diagram

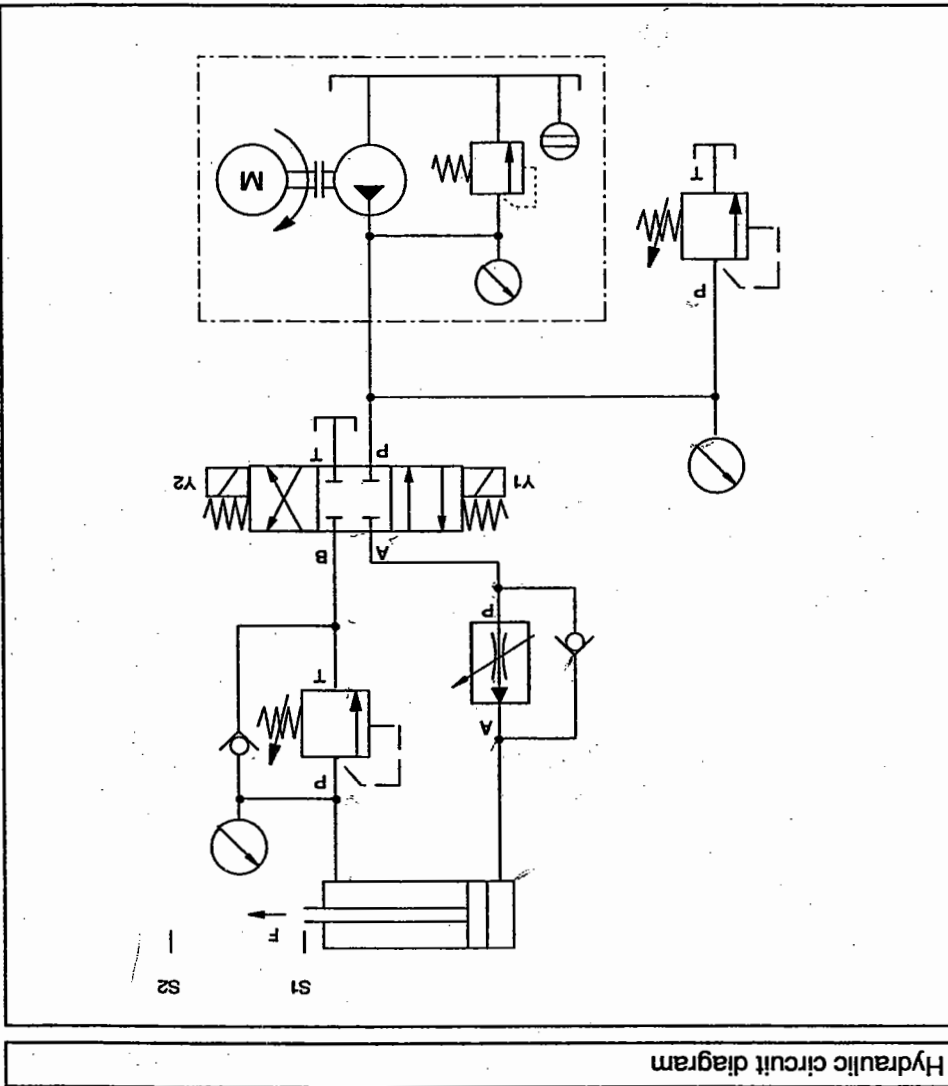

after switchover of S4 to manual operation, the piston rod retracts as long as push-button S5 is held down.

Manual operation:

relay K1 energised: piston rod advances
 relay K2 energised: piston rod in retracted end position
 relay K3 energised: piston rod retracts

Automatic operation:

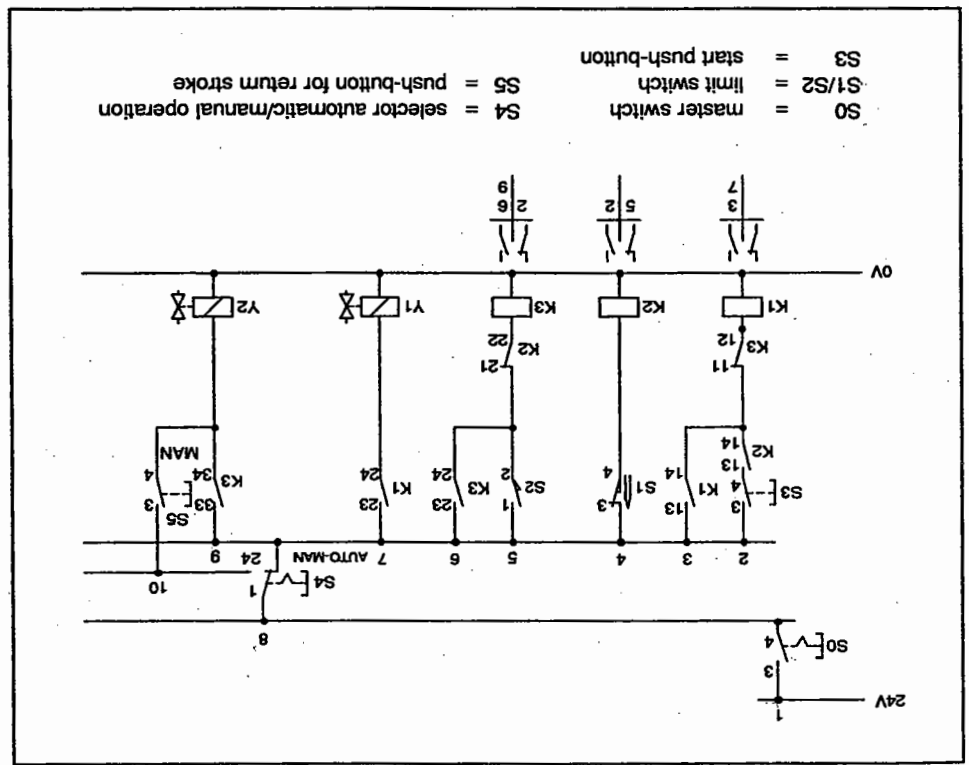

Electrical circuit diagram

2. Switchover from automatic to manual operation via control switch

A further contact of K2 is located in current path 2. This means that the pressing process cannot begin until the piston rod is retracted – only then are the start conditions fulfilled.

The actual pressure should not exceed the maximum pressure during retraction of the piston rod. The pressure switch must therefore be rendered inoperative during retraction. To this end, the contact of K4 blocks current path 5 until the piston rod is in its starting position. Limit switch S1 is actuated and relay K2 releases the latching of K4.

Malfunction:
if the pressure exceeds 40 bar when the piston rod advances, pressure switch B1 switches relay K3 to latching. The first contact of K3 releases the latching of relay K1 in current path 2. The piston rod retracts. The second contact closes current path 7, and the optical indicator lights up. Acknowledgement push-button S4 releases the latching of relay K3. The light goes out and start-up can be effected.

Normal movement:
when start push-button S3 is pressed, the piston rod advances up to limit switch S2. K4 energises and reverts to latching. The normally closed contact of K4 in current path 2 releases the latching of relay K1.

6. Function description

Exercise 12

Milling machine

1. Hydraulic circuit diagram

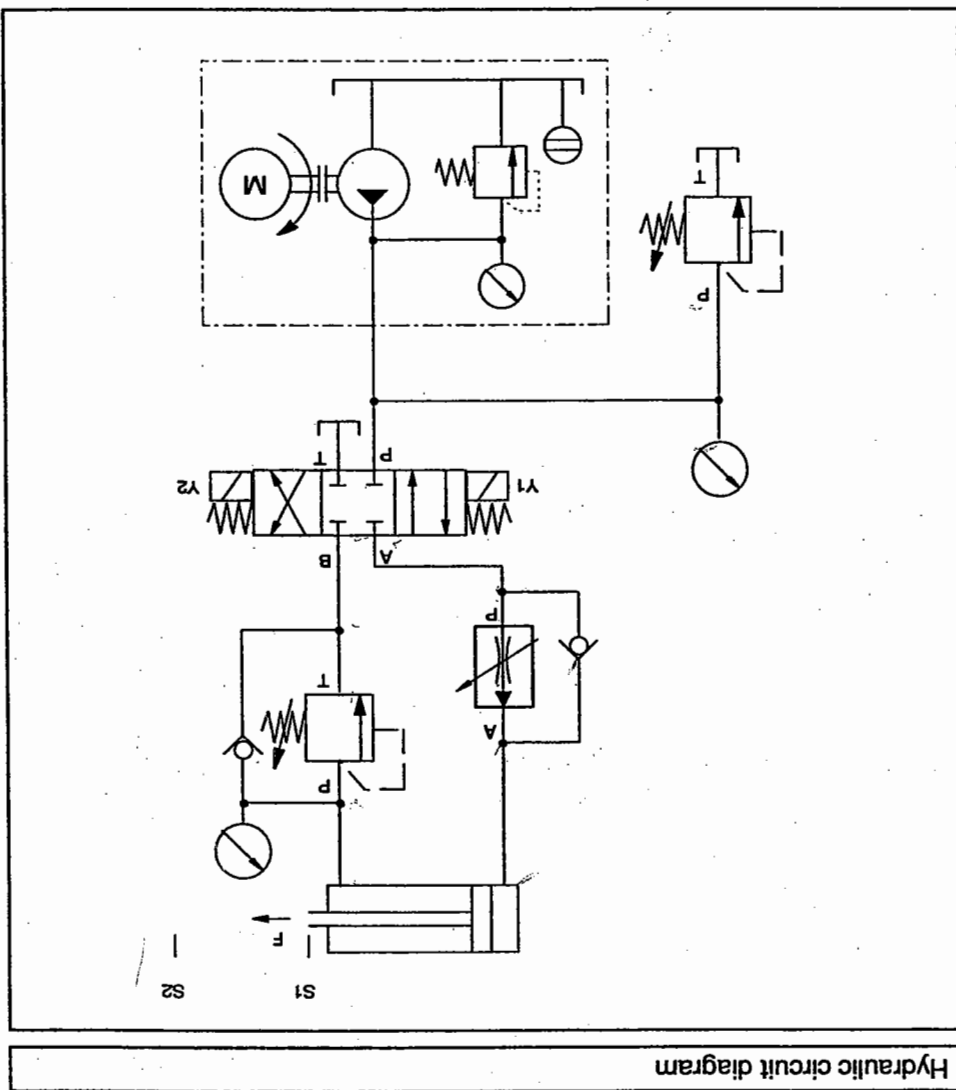

Manual operation:
 after switchover of S4 to manual operation, the piston rod retracts as long as push-button S5 is held down.

Automatic operation:
 relay K1 energised: piston rod advances
 relay K2 energised: piston rod in retracted end position
 relay K3 energised: piston rod retracts

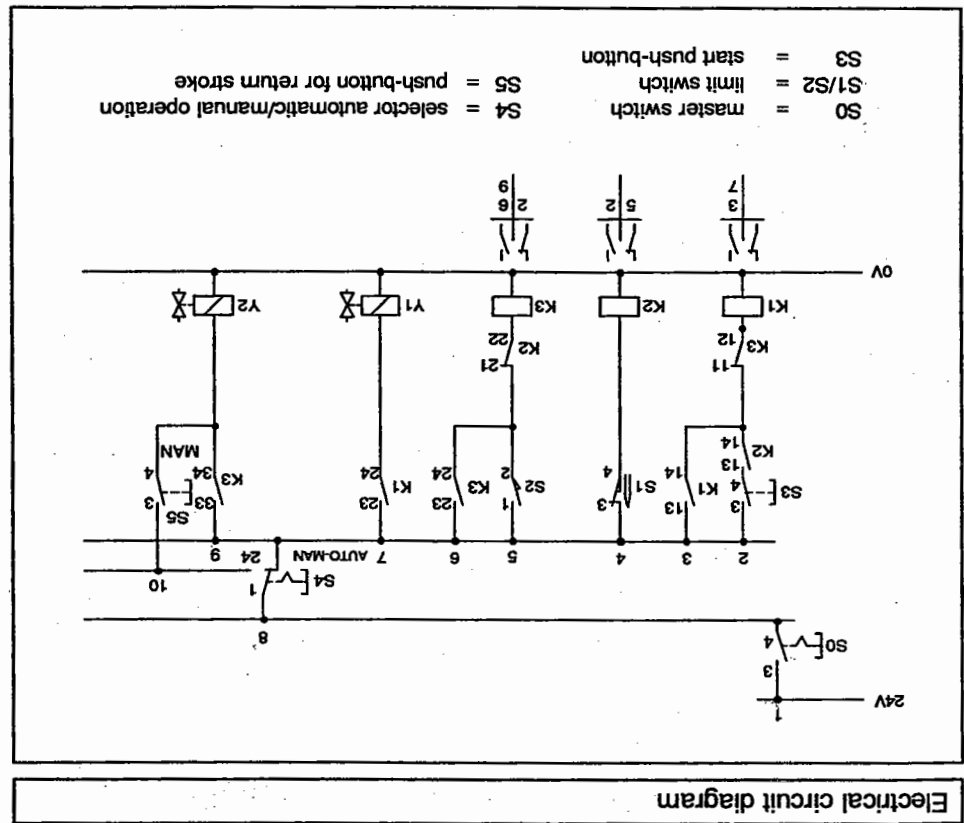

2. Switchover from automatic to manual operation via control switch

3. Switchover from automatic to manual operation via push-button

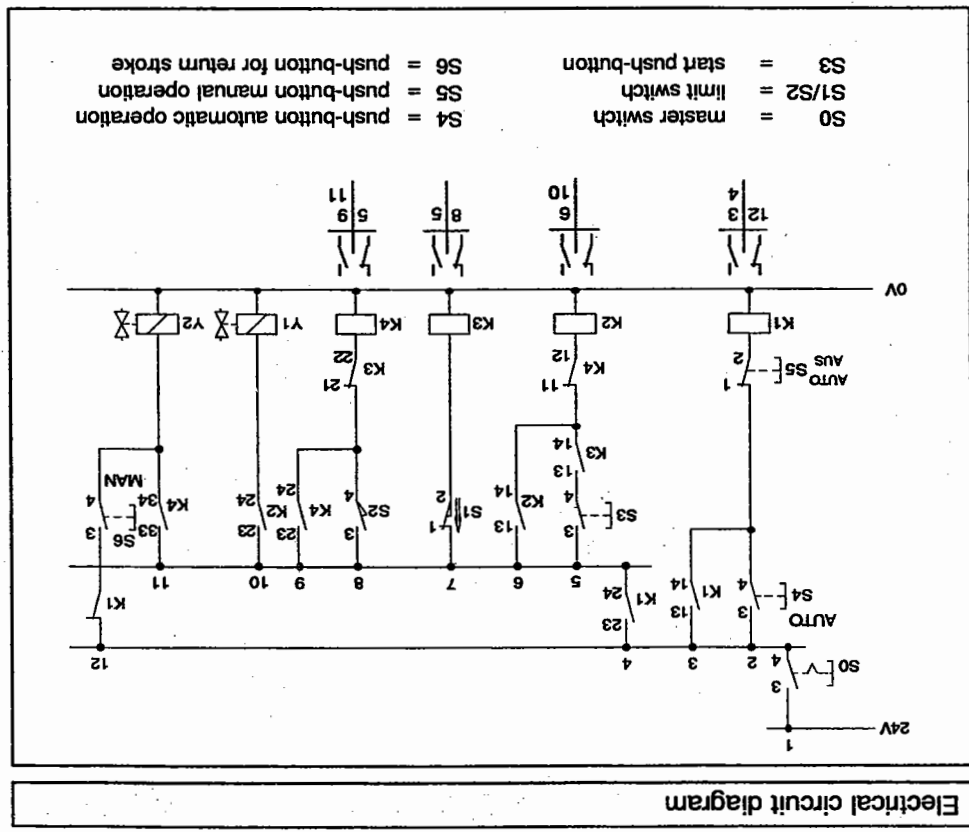

Automatic operation:

relay K1 energised: automatic operation
 relay K2 energised: piston rod advances
 relay K3 energised: piston in retracted end position
 relay K4 energised: piston rod retracts

Manual operation:

pressing push-button S5 releases the latching of relay K1. This causes normally closed contact K1 in current path 12 to close; the piston rod retracts as long as push-button S6 is held down.

Appendix

Standards for electro-hydraulic systems

Safety regulations for hydraulic lines	ZH	1/74	
Installation of pressure vessels: Safety requirements	TRB	600	
Operation of pressure vessels: Safety requirements	TRB	700	
Fluid-power systems and equipment: Circuit symbols	DIN ISO	1219	
Function diagrams for machinery and production plant	VDI	3260	
Fluid power technology — Hydraulic: Cylinder bores and piston rod diameters	DIN ISO	3320	
Fluid power technology — Hydraulic: Nominal pressures for cylinders	DIN ISO	3322	
Fluid power technology — Hydraulic: Slow-burning hydraulic fluids Guidelines	VDMA	24 317	
Fluid power technology — Hydraulic: Hydraulic systems Fundamentals of design	DIN	24 346	
Fluid power technology — Hydraulic: Circuit diagrams	DIN	24 347	
Hydraulic reservoirs: General requirements	DIN	24 552	
Pressure fluids: Hydraulic oil	DIN	51 524	
Testing of mineral oils, liquid fuels and allied fluids	DIN	51 561	
Viscometers Measurement of kinematic viscosity using the Ubbelohde viscometer	DIN	51 562	Parts 1 - 3

DIN VDE	0100	Installation of power systems up to 1000 V	Standards for electrical engineering
EN	60204	Electrical equipment of industrial machinery	
DIN VDE	0113	Industrial machinery	
IEC	144	Specification for the protection classes of enclosures for switching and control equipment for voltages up to and including 1000 V AC and 1200 V DC	
DIN	2909	Round fasteners: Summary	
DIN	2909	Round fasteners: Individual parts	
DIN	19 226	Closed and open-loop control technology: Terms and designations	
DIN	19 237	Measuring, controlling, regulating: Control technology, terms	
DIN	19 250	Basic safety considerations for measuring, controlling and regulating protective devices	
DIN	31 000	General guidelines regarding safe construction of technical products	
DIN	40 050	IP protection classes: Protection against shock, foreign matter and water for electrical equipment	
DIN	40 713	Circuit symbols	
DIN	40 719	Circuit documentation: Designation of electrical equipment	
DIN	40 719	Circuit documentation: Rules for circuit diagrams in electro-technology	
DIN	40 719	Circuit documentation: Design of connection diagrams	
DIN	40 900	Graphic symbols for circuit documentation (Symbols for switching and protective equipment)	

41 488	DIN	Electro-technology Compartment measurements for control cabinets
41 494	DIN	Construction of electronic equipment
43 650	DIN	Plug connectors, square design Types, dimensions, designation system
43 650	DIN	Plug connectors, square design Characteristics, requirements, testing
43 880	DIN	Installation equipment Overall dimensions and related installation dimensions
50 005	DIN EN	Industrial low-voltage switchgear Terminal designations and code numbers, General rules
50 011	DIN EN	Industrial low-voltage switchgear Terminal designations, code numbers and letters for specific auxiliary contactors
50 012	DIN EN	Industrial low-voltage switchgear Terminal designations and code numbers for auxiliary contacts of specific contactors
50 013	DIN EN	Industrial low-voltage switchgear Terminal designations and code numbers for specific control devices
50 022-35	DIN EN	Industrial low-voltage switchgear Terminal designations and code numbers

Index

Capacitance	123
Capacitive effect	132
Capacitive proximity sensor	135
Capacitor	123, 144
Changeover contact	47, 130
Charge capacitor	121
Charging current	123
Check valve	19
Circuit	144
Circuit diagram, electrical	
connection designs for switching elements	32
current path direction	33
function digit	32
ordinal number	32
relay terminal designations	32
switching element table	35
Circuit diagram, hydraulic	28
designation of components	30
distinctive number	30
energy flow	28
equipment numbering	30
group assignment	30
ordinal number	30
coil with iron core	122
Conjunction	72
Contact erosion	49
Contactor	137 - 139
Contacts	47

C

Boolean basic logic functions	54, 72
Bridge circuit	121
Bypass circuit	96

B

AC solenoid	141
Actuated position	
directional control valve	46
Action modes, directional control valves	16
Air-core reactor	122
Alternating current	118
Ammeter	126
internal resistance	126
AND operation	73
Arcing	141
Auxiliary contacts	139

A

Control cabinet 145

Control diagram 36

Control loop system 29

Control switch 47, 110, 129

Counter-pressure valve 98

Current measurement 126

Current strength 118, 120

Cylinder 20

differential 20

double-acting 20

end position cushioning 21

single-acting 20, 46

synchronous 20, 96

telescopic, double-acting 21

telescopic, single-acting 20

D

DC current circuit 119

DC solenoid 65

stroke-force characteristic 140

Differential circuit 96

Diffuse sensor 136

Diode 121, 144

Direct current 118

Direction of flow 14 - 15

Directional control valve 46

3/2-way valve 65

4/2-way solenoid valve 108

4/3-way solenoid valve 16

actuation 15

symbol 72, 77

Disjunction 95

Displacement control 35

Displacement-Step diagram 36

Displacement-Time diagram 23

Double non-return valve, symbol 87

Double solenoid valve 115

Drive section 115

Hazard zones, AC and DC current	152
Hydraulic power pack	44
symbol	23
Hydraulic motor, symbol	14
Hydro pump, symbol	14

H

Graetz circuit	121
----------------	-----

G

Flow control	95
Flow control valve	18, 97, 103
Flow regulator	18, 97
Flow valve	18
adjustable	18
Function diagram	35

F

Electrical conductor	119
conductor material	119
Electric current	152
effect on the human body	152
Electrical input elements	129
Electrical resistance	119
Electro-hydraulic system	39, 41
repair and maintenance	151
startup	151
Electro-hydraulics	10
advantages	10
field of application	10
Electromagnetic switches	51
Electromagnetism	122
EMERGENCY STOP switch	156
End position cushioning	21, 77
adjustable	21, 78, 82
both ends	21, 78, 82
one end	21
Energy conversion	114
Energy transfer symbols	22
Exclusive OR	81 - 83

E

Negation 55, 57, 72 – 73
 Non-return valve 19
 Normal position 15
 directional control valve 46
 pressure valve 16
 Normally closed contact 47, 130
 Normally open contact 47, 129
 NOT function 73

M

Magnet field 122
 Main contact elements 139
 Maintenance 151
 Master switch 47, 156
 Measurements in a circuit 124
 Measuring instrument 124
 indicating error 124
 symbols 23
 Measuring rules 124
 Motor, voltage supply 148

M

Latching 92, 108
 dominant setting 92
 dominant resetting 92
 Limit switch 98, 131
 Line sockets 142 – 143
 Logic operations/functions 72

L

Identity 72
 Inductive proximity sensor 134
 Insulation 154
 Interface 33, 115
 Interlock, electrical 87, 108
 Internal resistance 153
 ammeter 153
 voltmeter 125
 Internal resistance of the human body 153
 Isolating transformer 154

Parts list	31
Piezoelectric effect	132
Piezoresistive effect	132
Piloted non-return valve	19
Power	
electrical	120
electrical consumption	121
Power control section	115
Power section	11, 114
Power control supply section	114
Power supply unit	47, 128
modules	129
Pressure medium preparation, symbols	22
Pressure regulator	17, 91
Pressure relief valve	17
Pressure switch	104, 131
diaphragm pressure switch	132
piston pressure switch	132
Pressure valve	16 – 17
Protective cover	155
Protective measures	154
Proximity sensors	133
block symbols	26
capacitive	135
inductive	134
optical	135
Push-button	47, 110, 129

P

Ohm's law	120
One-way flow control valve	51
Optical proximity sensor	135
OR function	77 – 78
Outflow throttling	103 – 104
Overload protection devices	155

O

R

Rectifier	121
Reducing the return stroke speed	50
Reed switches	133
Relay	137
terminal designations	138
Repair	151
Resistance	119
Resistance effect	132
Resistance, inductive	123
with alternating voltage	123
with direct voltage	123
Resistor	144
Retro-reflective sensor	136

S

Safe distance	155
Safety voltage	148
Safety recommendations	152
electrical	150
hydraulics	33
Schematic diagram	131 - 135
Sensors	131
tasks	107
Sequence control	102
Sequence control system	145
Shock protection	19
Shut-off valve	11, 114 - 115, 128
Signal control section	115
Signal input	115
Signal processing	55 - 56, 58 - 61, 64 - 67, 69
Signal reversal	57
electrical	55, 68
hydraulic	90
electrical	86
hydraulic	140 - 141
Solenoid	142
dry	142
plug connector	65, 141
wet	16
Solenoid valve	45
Solenoid valve actuation	50
direct	
indirect	

Valve solenoid coil, actuation	33
Valve ports	15
Voltage measurement	125
Voltage supply, electric motor	148
Voltmeter	125

V

Technical direction of current	119
Tensile load	98
Terminal allocation	145
Terminal allocation list	145
Throttle control	95
Through-beam sensor	135
Two-way circuit	82

T

Source voltage	119
Spark suppression	143
Speed control	50, 95, 97
Start-up	42, 151
Suppressor circuit	144
Switching elements	24 - 25
electromechanical	25
Switching position	15
Symbols	14
electrical	24
hydraulic	14
Synchronous cylinder	20, 96



This book provides an easy to understand introduction to the field of automation technology.

It can be used as:

An exercise book

Part A is designed as a training course. The reader is provided with a step-by-step introduction to automation technology by way of a series of practical examples and exercises. Part C contains the solutions to the exercises in Part A.

A reference work

Part B deals with basic theoretical and technical information for the subject concerned. This section is laid out systematically according to subject matter and technical terms.

This book is closely related to practice:

Each training section provides practical information. Numerous illustrations enable the student to gain a thorough understanding of the topics covered; they also speed up and simplify the learning process.

The book is user-orientated and geared towards the individual:

The student can himself define the scope of the training material to be studied and can then proceed at his own speed. He can assess his progress at any stage with the help of the exercises and tests provided.