

INPUT ELEMENT 3

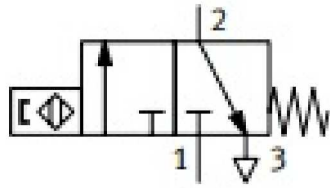

Proximity sensor with cylinder mounting

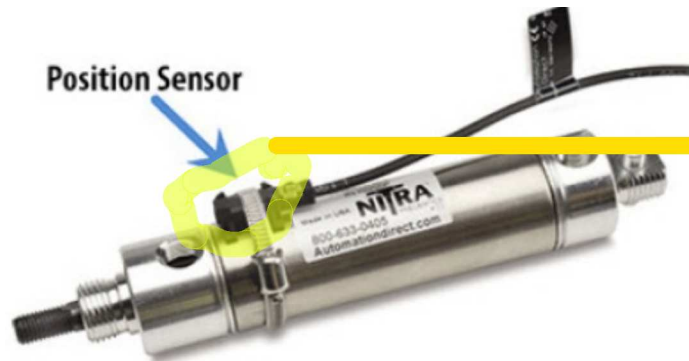
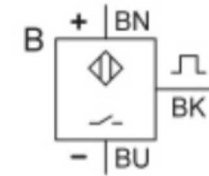

Position Sensor

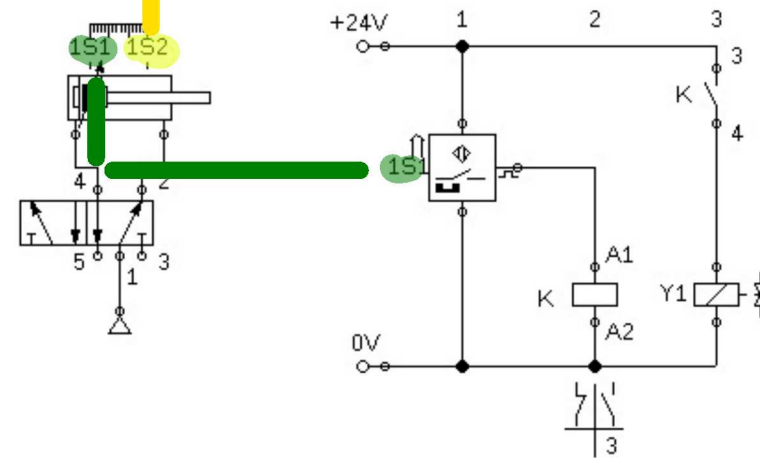

Pneumatic

Electronneumatic

Grafik Pergerakan Pneumatic 3

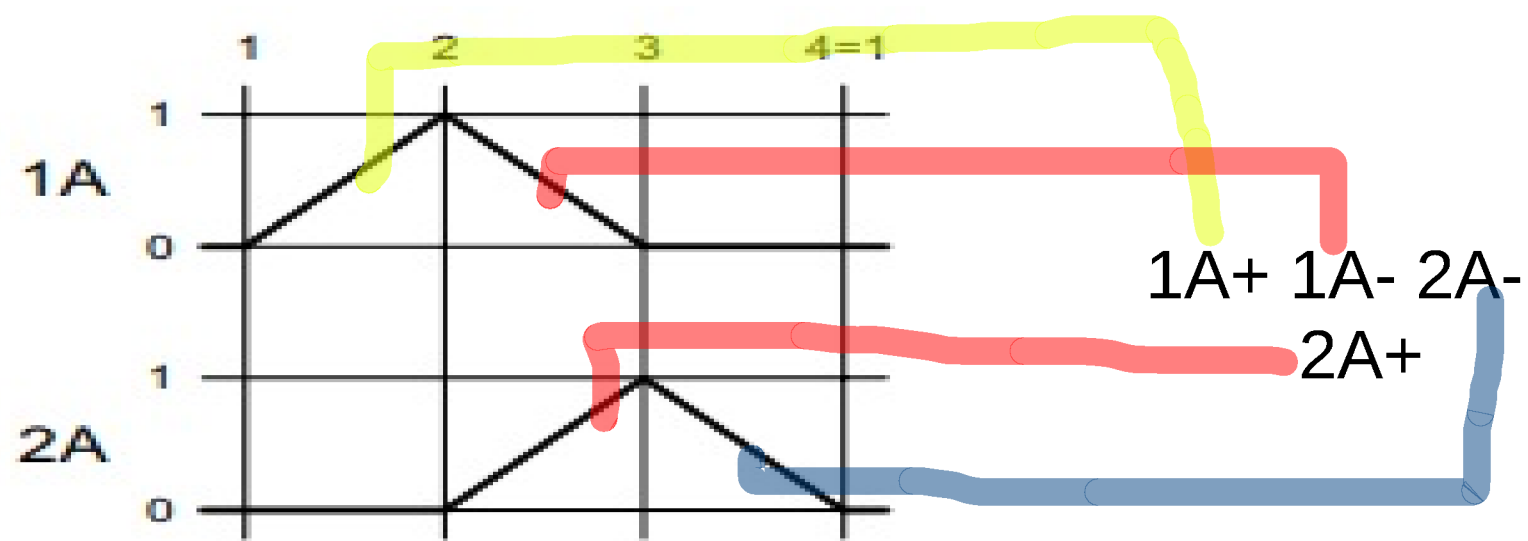
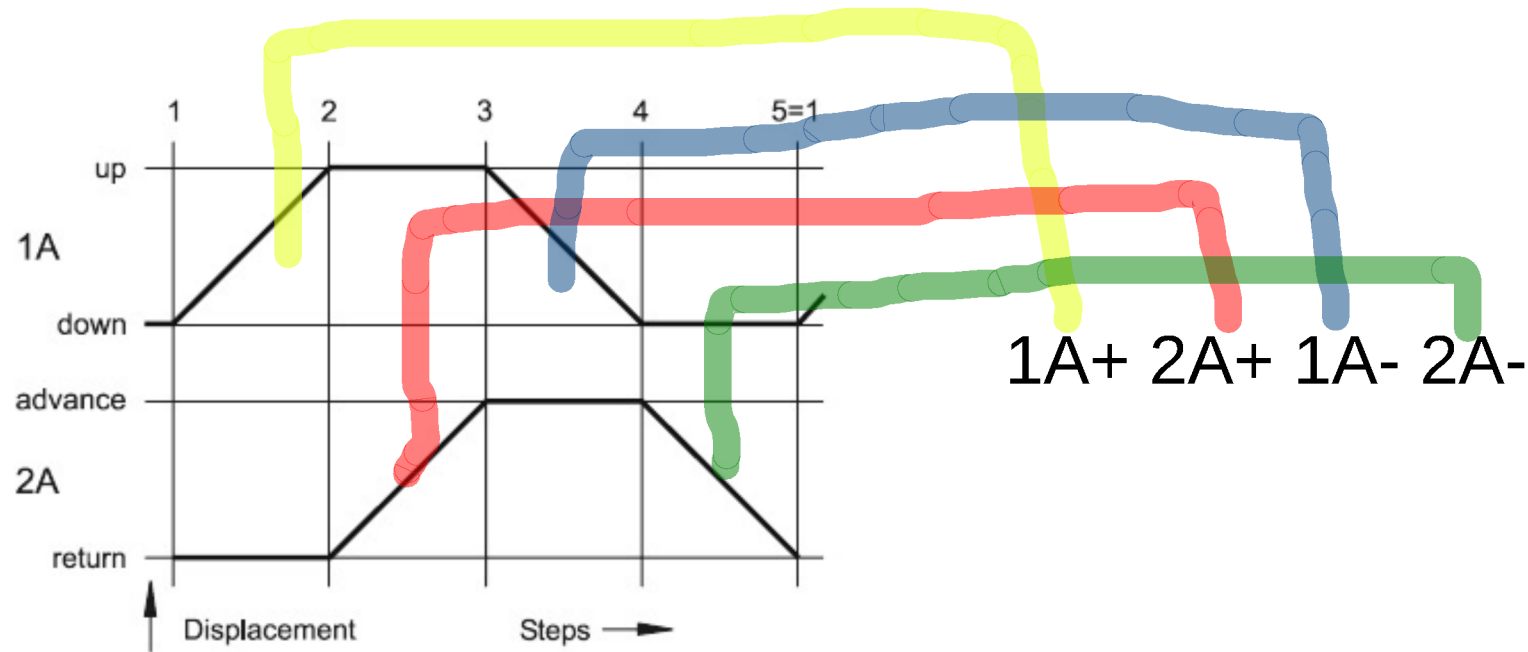

INPUT ELEMENT 3

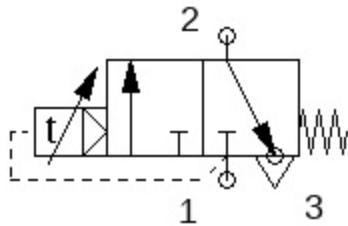

Pneumatic Timer, Normally Close

Pneumatic

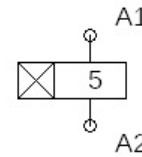

Switch-On Delay

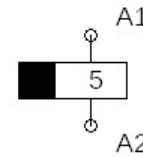

Switch-Off Delay

Electronneumatic

INPUT ELEMENT 3

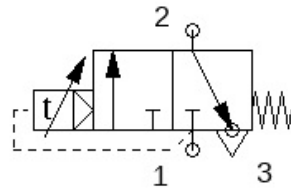

Pneumatic Timer, Normally Close

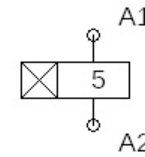

Switch-On Delay

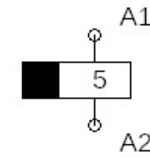

Switch-Off Delay

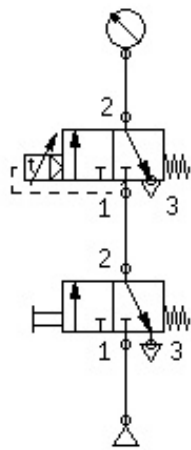

Pneumatic

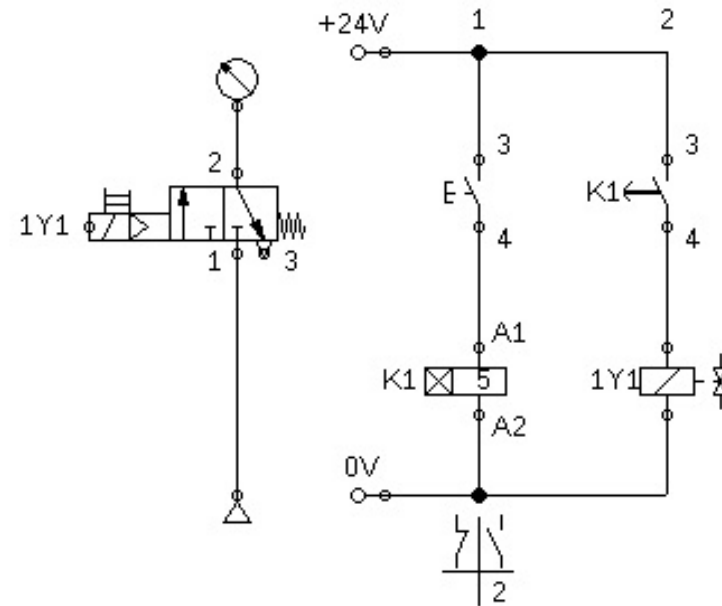

Electropneumatic