

Pneumatics Basic Level

FESTO

Workbook TP 101



CD-ROM included

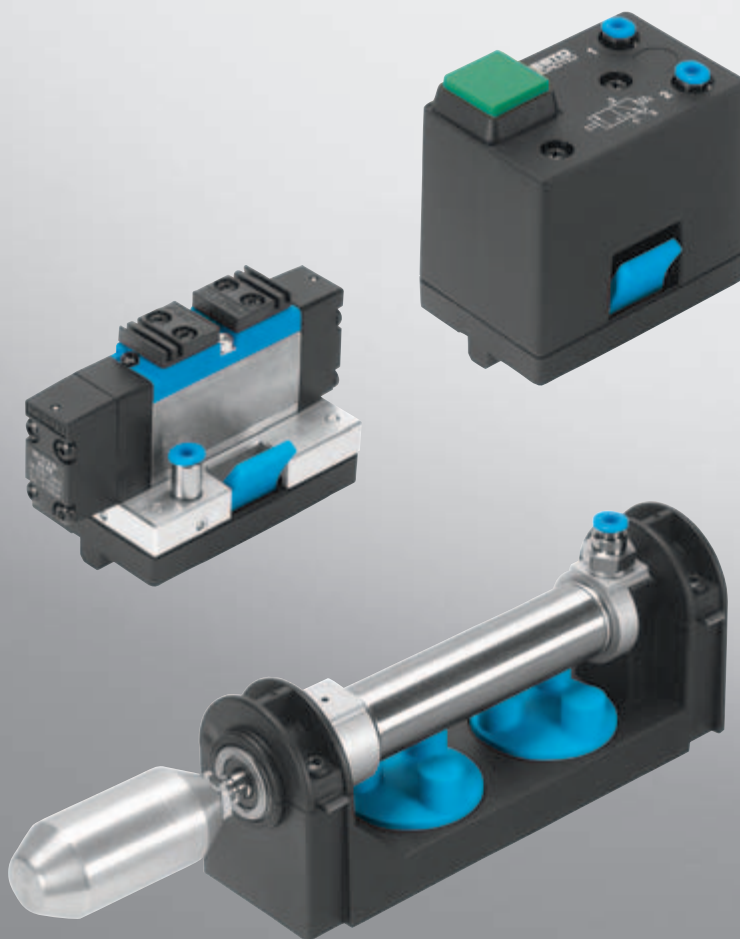

Intended use

The Festo Didactic Learning System has been developed and produced solely for vocational and further training in the field of automation and technology. The training company and/or instructor needs to ensure that trainees observe the safety precautions specified in this workbook.

Festo Didactic hereby disclaims any legal liability for damages or injury to trainees, the training company and/or other third parties, which may occur during the use/application of this equipment set other than in a training situation and unless such damages are caused by intention or gross negligence on the part of Festo Didactic.

Order No.:	541088
Status:	04/2005
Authors:	W. Haring, M. Metzger, R.-C. Weber
Editor:	Frank Ebel
Graphics:	Doris Schwarzenberger
Layout:	08/2005

© Festo Didactic GmbH & Co. KG, 73770 Denkendorf, Germany, 2005
Internet: www.festo-didactic.com
e-mail: did@festo.com

The copying, distribution and utilization of this document as well as the communication of its contents to others without expressed authorization is prohibited. Offenders will be held liable for the payment of damages. All rights reserved, in particular the right to carry out patent, utility model or ornamental design registration.

Contents

Preface	5
Introduction	7
Notes on safety and operation	9
Technology package for pneumatics (TP100)	11
Training aims of Basic Level (TP101)	13
Allocation of training aims and exercises	15
Equipment set - Basic Level (TP101)	17
Allocation of equipment and exercises	21
Methodical help for the trainer	23
Methodical structure of the exercise	25
Designation of equipment	26
Contents of the CD-ROM	27
Equipment set of Advanced Level (TP102)	29
Training aims of Advanced Level (TP102)	30

Part A – Exercises

Exercise 1: Pressing of cheese wheels	A-3
Exercise 2: Opening of an animal feed silo	A-11
Exercise 3: Testing of key blanks	A-17
Exercise 4: Sorting of packages	A-23
Exercise 5: Stopping crates of drinks	A-35
Exercise 6: Opening and closing of a pipe	A-41
Exercise 7: Shutting off using a quick shut-off function	A-47
Exercise 8: Actuation of a shut-off device	A-53
Exercise 9: Brushing of cheese wheels	A-61
Exercise 10: Clamping of a workpiece	A-67
Exercise 11: Actuation of a sliding door	A-75
Exercise 12: Supplying of workpieces	A-81
Exercise 13: Crushing of drinks cans	A-87
Exercise 14: Packaging of brochures	A-93
Exercise 15: Mounting of locking clips	A-99
Exercise 16: Labelling of paint pots	A-105
Exercise 17: Cleaning of workpieces	A-111
Exercise 18: Pressing in of lids	A-117

Part B – Fundamentals

Part C – Solutions

Exercise 1: Pressing of cheese wheels _____	C-3
Exercise 2: Opening of an animal feed silo _____	C-9
Exercise 3: Testing of key blanks _____	C-13
Exercise 4: Sorting of packages _____	C-17
Exercise 5: Stopping crates of drinks _____	C-25
Exercise 6: Opening and closing of a pipe _____	C-29
Exercise 7: Shutting off using a quick shut-off function _____	C-33
Exercise 8: Actuation of a shut-off device _____	C-37
Exercise 9: Brushing of cheese wheels _____	C-41
Exercise 10: Clamping of a workpiece _____	C-47
Exercise 11: Actuation of a sliding door _____	C-51
Exercise 12: Supplying of workpieces _____	C-55
Exercise 13: Crushing of drinks cans _____	C-59
Exercise 14: Packaging of brochures _____	C-63
Exercise 15: Mounting of locking clips _____	C-67
Exercise 16: Labelling of paint pots _____	C-71
Exercise 17: Cleaning of workpieces _____	C-75
Exercise 18: Pressing in of lids _____	C-81

Part D – Appendix

Storage unit _____	D-2
Assembly technology _____	D-3
Plastic tubing _____	D-4
Data sheets	

Preface

Festo Didactic's Learning System for Automation and Technology is orientated towards different training and vocational requirements and is therefore structured into the following training packages:

- Basic packages to provide basic knowledge in all areas of technology
- Technology packages to address the major subjects of open and closed-loop technology
- Function packages to explain the basic functions of automated systems
- Application packages to facilitate vocational and further training based on actual industrial applications

The technology packages deal with the following technologies: Pneumatics, electropneumatics, programmable logic controllers, automation using a personal computer, hydraulics, electrohydraulics, proportional hydraulics and handling technology.



The modular design of the learning system enables applications beyond the limits of the individual packages. For example, to facilitate PLC actuation of pneumatic, hydraulic and electrical drives.

All the training packages are of identical structure:

- Hardware
- Teachware
- Software
- Seminars

The hardware consists of didactically designed industrial components and systems.

The didactic, methodical design of the teachware is harmonised with the training hardware and comprises:

- Textbooks (with exercises and examples)
- Workbooks (with practical exercises, additional information, solutions and data sheets)
- Overhead transparencies and videos (to create an interesting and lively training environment)

Tuition and training media are available in several languages and are suitable for use in both the classroom and self-tuition.

Software is available in the form of computer training programs and programming software for programmable logic controllers.

A comprehensive range of seminars dealing with the topics of the technology packages completes the range of vocational and further training available.

Introduction

This workbook is a component part of the Learning System for Automation and Technology of Festo Didactic GmbH & Co. KG. This system provides a solid basis for practice-oriented vocational and further training. The technology package TP100 is comprised exclusively of pneumatic control systems.

Basic Level TP101 is suitable for basic training in pneumatic control technology and provides knowledge regarding the physical fundamentals of pneumatics and the function and use of pneumatic equipment. The equipment set enables you to construct simple pneumatic control systems.

Advanced Level TP102 focuses on further training in pneumatic control technology. The equipment set enables you to construct complex combinational circuits using logic operations of input and output signals and control systems using sequencer modules.

Prerequisite for the assembly of control systems is a fixed workstation using a Festo Didactic profile plate, consisting of 14 parallel T-slots at 50 mm spacing. A mobile, sound attenuated compressor (230 V, maximum 8 bar = 800 kPa) can be used for pressure supply.

Working pressure must not exceed a maximum of $p = 6 \text{ bar} = 600 \text{ kPa}$.

Optimum operational reliability is achieved if the control system is operated unlubricated at a working pressure of $p = 5 \text{ bar} = 500 \text{ kPa}$.

The Basic Level TP101 equipment set is used to construct all of the complete control systems for the 18 exercise definitions. The theoretical fundamentals to help you understand this collection of exercises can be found in the textbook

- Pneumatics, Basic Level

Also available are data sheets regarding the individual devices (cylinders, valves, measuring devices, etc..).

Introduction

Notes on safety and operation



The following advice should be observed in the interest of your own safety:

- Pressurised air lines that become detached can cause accidents. Switch off supply immediately.
- Do not switch on compressed air until tubing is securely connected.
- **Caution!**
Cylinders may advance automatically as soon as the compressed air is switched on.
- Do not operate roller lever valves manually during fault finding (use a tool).
- Observe general safety regulations (DIN 58126).
- Limit switches must be mounted laterally to the trip cam (not from the front).
- Do not exceed the permissible working pressure (see data sheets).
- Pneumatic circuit design: Connect devices using the silver metallic plastic tubing of 4 mm outer diameter, plugging the tubing into the push-in fitting up to the stop; no need for securing!
- Releasing of push-in fitting: The tubing can be released by pressing down the releasing ring (disconnection under pressure is not possible!)
- Switch off compressed air supply prior to dismantling the circuit.
- The mounting plates of the devices are equipped with mounting variants A, B or C:

Variant A, latching system

For lightweight non loadable devices (e.g. directional control valves). Simply clip the devices into the slot in the profile plate. Devices can be released by pressing the blue lever.

Variant B, rotary system

Medium weight loadable devices (e.g. actuators). These devices are clamped onto the profile plate by means of T-head bolts. Clamping and releasing is effected via the blue knurled nut.

Variant C, screw system

For heavy loadable devices or equipment rarely removed from the profile plate (e.g. Start-up valve with filter control valve). These devices are mounted by means of socket head screws and T-head bolts.

- The data for the individual devices specified in the data sheets in Part D must be observed.

A stop watch is required to evaluate the control systems assembled. This is used to:

- Adjust one-way flow control valves such that the cylinder stroke time achieves specified values,
- Set time delay valves.

Technology package for pneumatics (TP100)

The technology package TP100 consists of numerous training media as well as seminars. The object of this package is exclusively pneumatic control systems. Individual components from the technology package TP100 may also form a component part of other packages.

Important elements of TP100

- Fixed workstation with Festo Didactic profile plate
- Compressor (230 V, 0.55 kW, maximum 8 bar = 800 kPa)
- Equipment sets of individual components (e.g. cylinders, directional control valves, predetermining counters, stepper modules, logic elements, pneumatic proximity sensors)
- Optional training aids (e.g. visual displays, 5/3-way valve, pulling/pushing load)
- Practical training models
- Complete laboratory setups

Training documentation	
Textbooks	Basic Level TP101 Fundamentals of pneumatic control technology Maintenance of pneumatic devices and systems
Workbooks	Basic Level TP101 Advanced Level TP102
Optional Teachware	Sets of overhead transparencies Magnetic symbols, drawing template Simulation software FluidSIM® Pneumatic WBT Fluid Studio Pneumatic Cutaway model set 1 + 2 with storage case

Technology package for pneumatics (TP100)

Seminars	
P111	Fundamentals of pneumatics and electropneumatics
P121	Maintenance of and fault finding on pneumatic and electropneumatic systems
IW-PEP	Maintenance and servicing in control technology – pneumatic and electropneumatic control systems
P-AL	Pneumatics for vocational training

Details of venues, dates and prices can be found in the current seminar planner.

Information regarding further training media is available in our catalogues and on the Internet. The Learning System for Automation and Technology is continually updated and expanded. The sets of overhead transparencies, films, CD-ROMs and DVDs as well as technical books are available in several languages.

Training aims of Basic Level (TP101)

- To familiarise yourself with the design and mode of operation of a single-acting cylinder.
- To familiarise yourself with the design and mode of operation of a 3/2-way valve.
- To be able to identify and draw types of directional control valve actuation.
- To be able to explain and design a direct actuation.
- To be able to analyse and evaluate circuits.
- To familiarise yourself with the design and mode of operation of a double-acting cylinder.
- To familiarise yourself with the design and mode of operation of a 5/2-way valve.
- To be able to explain and design an indirect actuation.
- To familiarise yourself with the mode of operation of a 5/2-way valve with pneumatic actuation.
- To be able to differentiate between a signalling element and a control element.
- To be able to measure pressure in pneumatic control systems.
- To be able to differentiate between and utilise types of flow control according to specifications.
- To be able to set cylinder advancing and retracting speeds.
- To familiarise yourself with one type of signal storage in pneumatic control systems.
- To be able to explain and realise logic AND/OR/NOT operations.
- To be able to explain and configure latching circuits.

- To familiarise yourself with one possibility of cylinder end position sensing.
- To be able to combine logic operations.
- To familiarise yourself with the design and mode of operation of magnetic proximity sensors.
- To be able to differentiate between and select and use 5/2-way valves according to specifications.
- To be able to further develop existing circuits.
- To familiarise yourself with the design and mode of operation of a pressure sequence valve.
- To be able to design pressure-dependent control systems.
- To familiarise yourself with the design and mode of operation of a pressure regulating valve.
- To be able to analyse circuits and optimise these according to specifications.
- To familiarise yourself with the design and mode of operation of a time delay valve.
- To be able to design circuits with oscillating movements.
- To be able to use time delay valves dependent on parameters.
- To be able to analyse and design circuits using two cylinders.

Allocation of training aims and exercises

Exercise	1	2	3	4	5	6	7	8	9	10	11	12	13	14	15	16	17	18
Training aims																		
To familiarise yourself with the design and mode of operation of a single-acting cylinder.	•	•	•															
To familiarise yourself with the design and mode of operation of a 3/2-way valve.	•	•	•															
To be able to identify and draw types of directional control valve actuation.	•	•	•															
To be able to explain and design an example of direct actuation.	•	•	•	•														
To be able to analyse and evaluate circuits.			•												•			
To familiarise yourself with the design and mode of operation of a double-acting cylinder.				•														
To familiarise yourself with the design and mode of operation of a 5/2-way valve.				•	•													
To be able to explain and design an example of indirect actuation.					•				•									
To be able to differentiate between a signalling element and a control element.					•													
To be able to measure pressure in pneumatic control systems.						•												
To be able to differentiate between and utilise types of flow control according to specifications.						•	•											
To be able to set cylinder advancing and retracting speeds.							•	•										

Allocation of training aims and exercises

Exercise	1	2	3	4	5	6	7	8	9	10	11	12	13	14	15	16	17	18
Training aims																		
To familiarise yourself with one type of signal storage in pneumatic control systems.								•										
To be able to explain and realise logic AND/OR/NOT operations.									•	•	•	•						
To be able to explain and design latching circuits.									•									
To familiarise yourself with one possibility of cylinder end position sensing.										•								
To be able to combine logic operations.											•	•						
To familiarise yourself with the design and mode of operation of magnetic proximity sensors.											•							
To be able to differentiate between and select and use 5/2-way valves according to specifications.											•							
To be able to further develop existing circuits.												•						
To familiarise yourself with the design and mode of operation of a pressure sequence valve.													•					
To be able to design pressure-dependent control systems.													•	•	•	•		
To familiarise yourself with the design and mode of operation of a pressure regulating valve.														•				
To familiarise yourself with the design and mode of operation of a time delay valve.																•		
To be able to design circuits with oscillating movements.																		•
To be able to use time delay valves dependent on parameters.																		•
To be able to analyse and design circuits using two cylinders.																		•

Equipment set – Basic Level (TP101)

This equipment set has been compiled for basic training in pneumatic control technology. It contains all the components required to meet the specified training aims and can be expanded in any way with other equipment sets. The profile plate and a compressed air supply are required in addition.

Equipment set – Basic Level (TP101 Order No.: 540710)

Description	Order No.	Quantity
3/2-way pneumatic valve, pneumatically actuated, one side	539768	1
3/2-way roller lever valve, normally closed	152866	2
3/2-way valve with pushbutton actuator, normally open	152861	1
3/2-way valve with pushbutton actuator, normally closed	152860	2
3/2-way valve with selector switch, normally closed	152863	1
5/2-way double pilot valve, pneumatically actuated, both sides	539769	3
5/2-way valve, pneumatically actuated, one side	538694	1
5/2-way valve with selector switch	152862	1
Double-acting cylinder	152888	1
Dual-pressure valve (AND)	539770	2
Manifold	152896	1
One-way flow control valve	539773	2
Plastic tubing, 10 m, PUN 4 x 0.75	151496	2
Pressure gauge	152865	2
Pressure regulator valve with gauge	539756	1
Pressure sequence valve	152884	1
Proximity switch, pneumatic, with cylinder attachment	539775	2
Push-in sleeve	153251	10
Push-in T-connector	153128	10
Quick-exhaust valve	539772	1
Shuttle valve (OR)	539771	1
Single-acting cylinder	152887	1
Start-up valve with filter control valve	540691	1
Time-delay valve, normally closed	540694	1

Equipment set symbol

Description	Symbol
3/2-way valve with pusbutton actuator, normally closed	
3/2-way valve with pushbutton actuator, normally open	
5/2-way valve with selector switch	
3/2-way valve with selector switch	
Pressure gauge	
3/2-way roller lever valve, normally closed	
Pneumatic proximity switch	
3/2-way pneumatic valve, normally closed	
5/2-way pneumatic valve	
5/2-way pneumatic double pilot valve	

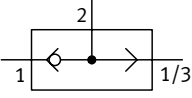
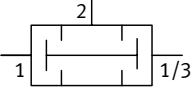
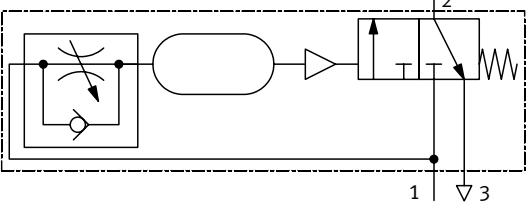
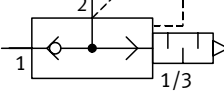
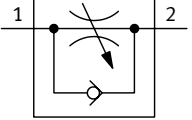
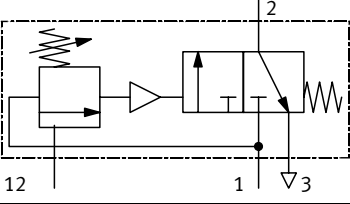
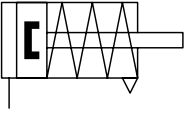
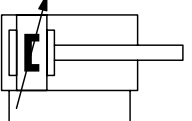
Description	Symbol
Shuttle valve	
Dual pressure valve	
Time delay valve, normally closed	
Quick exhaust valve	
One-way flow control valve	
Pressure sequence valve	
Single-acting cylinder	
Double-acting cylinder	

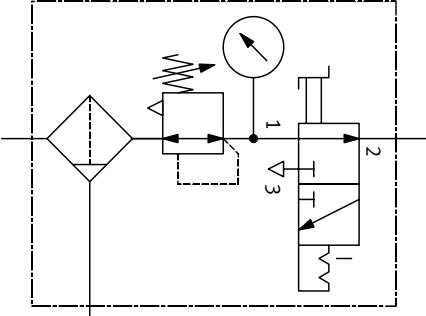
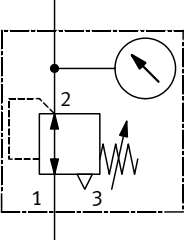
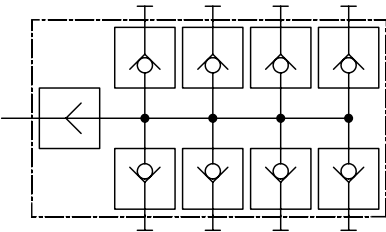
Description	Symbol
Start-up valve with filter control valve	
Pressure regulating valve with pressure gauge	
Manifold	
Connection elements	

Allocation of equipment and exercises

Exercise	1	2	3	4	5	6	7	8	9	10	11	12	13	14	15	16	17	18
Equipment																		
Cylinder, single-acting	1	1	1															1
Cylinder, double-acting				1	1	1	1	1	1	1	1	1	1	1	1	1	1	1
One-way flow control valve						2	2	1	2	2	2	2	2	2	2	1	2	2
Quick exhaust valve								1								1		
Pressure gauge						2	2	1		2						1		
3/2-way valve, pushbutton actuator, normally closed	1								1	2	2	1	2	2	1	1	1	1
3/2-way valve, pushbutton actuator, normally open		1							1									
3/2-way valve, selector switch, normally closed			1		1			2				1						
3/2-way roller lever valve, normally closed										1							1	1
Pneumatic proximity switch											2	2	2	1	2	2	2	2
3/2-way pneumatic valve									1						1			
3/2-way pneumatic double pilot valve																	1	1
5/2-way valve, selector switch				1		1	1											
5/2-way pneumatic valve					1				1	1	1							
5/2-way pneumatic double pilot valve								1				1	1	1	1	1	1	1
Shuttle valve									1		1		1				1	
Dual pressure valve										1	2	2	1	1	2	1		1
Pressure sequence valve													1	1	1			
Pressure regulating valve with pressure gauge													1	2	1	1		
Time delay valve, normally closed																1	1	
Manifold	1	1	1	1	1	1	1	1	1	1	1	1	1	1	1	1	1	1
Start-up valve with filter control valve	1	1	1	1	1	1	1	1	1	1	1	1	1	1	1	1	1	1

Methodological help for the trainer

- **Training aims**

The overall aim of this collection of exercises is the systematic design of circuit diagrams and practical assembly of a control system on a profile plate. This direct interaction of theory and practice ensures a quick progress with learning. The precise training aims are documented in the table. Actual individual training aims are allocated to each problem.

- **Time required**

The time required to work through a problem depends on the trainee's prior knowledge. Skilled workers in the engineering and electrical field require approximately 2 weeks. Technicians or engineers require approximately 1 week.

- **Components of the equipment set**

The collection of exercises and equipment set are harmonised. For all 18 exercises you only require the components of the equipment set of Basic Level TP101.

Each Basic Level exercise can be assembled on a profile plate.

Methodological structure of the exercises

All 18 exercises in Part A are of identical methodological structure.

The exercises are divided into:

- Title
- Training aims
- Problem definition
- Parameters

as well as

- Project task
- Positional sketch
- Worksheets

The proposed solutions in Part C are divided into:

- Circuit diagram
- Solution description

as well as

- Circuit assembly
- Equipment list

Designation of equipment

Components are designated in accordance with the DIN-ISO 1219-2 standard. All components of a circuit have the same main code number. Letters are assigned depending on component. Several components within a circuit are numbered consecutively. The designation of pressure ports is P and these are separately consecutively numbered.

Cylinder:	1A1, 2A1, 2A2, ...
Valves:	1V1, 1V2, 1V3, 2V1, 2V2, 3V1, ...
Sensors:	1B1, 1B2, ...
Signal input:	1S1, 1S2, ...
Accessories:	0Z1, 0Z2, 1Z1, ...

Contents of the CD-ROM

The CD-ROM supplied provides you with additional media. The contents of Part A – Exercises and Part C – Solutions are stored in the form of pdf files.

The structure of the CD-ROM is as follows:

- Operating instructions
- Data sheets
- Demo
- Festo catalogue
- FluidSIM® circuit diagrams
- Industrial applications
- Presentations
- Product information
- Videos

Operating instructions

Operating instructions are available for the various pieces of equipment of the technology package to assist you in the use and commissioning of the equipment.

Data sheets

The data sheets for the equipment of the technology package are available in the form of pdf files.

Demo

A demo version of the software package FluidSIM® Pneumatic is stored on the CD-ROM. This version is suitable for the testing of the control systems developed.

Festo catalogue

Pages from the Festo AG & Co. KG catalogue are provided for selected pieces of equipment. The representation and description of equipment in this form is intended to illustrate how such equipment is represented in an industrial catalogue. You will also find additional information here regarding the equipment.

FluidSIM® circuit diagrams

FluidSIM® circuit diagrams are stored in this directory for all of the 18 exercises in the technology package.

- Industrial applications** Photos and pictures are provided of industrial applications, whereby you can illustrate your own problem definitions. These illustrations can also be added to project presentations.
- Presentations** Brief presentations are stored in this directory regarding the equipment of this technology package. These presentations can for instance be used to create project presentations.
- Product information** This directory provides you with the product information and data sheets of Festo AG & Co. KG regarding the equipment of the technology package and is intended to explain what information and data are provided for an industrial component.
- Videos** A number of videos of industrial applications complete the media for the technology package. Short sequences are shown of practice-related applications.

Equipment set – Advanced Level (TP102)

This Advanced Level equipment set has been compiled for further training in pneumatic control technology. The two equipment sets (TP101 and TP102) comprise the components required for the specified training aims and can be expanded in any way with other equipment sets of the Learning System for Automation and Technology.

**Equipment set – Advanced Level (TP102)
Order No.: 540711)**

Description	Order No.	Quantity
3/2-way roller lever valve with idle return, normally closed	152867	1
3/2-way pneumatic valve, pneumatically actuated, one side	539768	4
3/2-way valve with pushbutton actuator, normally closed	152860	2
5/2-way double pilot valve, pneumatically actuated, both sides	539769	2
Double-acting cylinder	152888	2
One-way flow control valve	539773	2
Plastic tubing, 10 m, PUN 4 x 0.75	151496	2
3/2-way valve with mushroom-head emergency switch (red), normally open	152864	1
Non-return valve, delockable	540715	2
Back pressure valve	152868	1
Push-in sleeve	153251	10
Stepper module	152886	1
Push-in T-connector	153128	20
Time delay valve, normally open	539759	1
Pneumatic preset counter	152877	1
Shuttle valve (OR)	539771	1
Shuttle valve, 3-off (OR)	152882	1
Dual pressure valve, 3-off (AND)	152883	1

Training aims of Advanced Level (TP102)

- To detect end positions without limit switches
- To understand and design flip-flop circuits (flip-flop, double pilot valve)
- To convert a 3/2-way and/or 5/2-way valve
- To evaluate, use and adjust different sensors
- To explain the function of a back pressure end stop
- To describe the function of stepper (modules)
- To design basic stepper control systems (continuous cycle)
- To realise a stepper control system using the operating modes AUTOMATIC/MANUAL, START and RESET
- To realise the OR function of feedback signals
- To adjust and harmonise delays
- To be able to interrupt time delays via an OR function
- To realise a stepper control with idle step (3 steps)
- To describe and design variable step repetition within a motion sequence using a predetermining counter
- To develop an input circuit with self-latching loop and the functions AUTOMATIC/MANUAL, START, STOP at CYCLE END and RESET
- To evaluate and realise the use of sensors for material sensing
- To actuate a final control element using two stepper modules via a shuttle valve (double stroke of cylinder)
- To use a proximity sensor in the partial stroke range to realise the reversal of a cylinder
- To develop an input circuit for a stepper control with protected pilot air and the functions START, EMERGENCY-STOP and RESET
- To stop a cylinder within the partial stroke range (positioning) by means of pressure applied at both ends (pre-pressurise)
- To adjust proximity sensors in the end positions and in the partial stroke range
- The combined use of quick exhaust valve and pressure regulating valve with pressure gauge
- To design the inversion of a timer signal
- To realise a control system with command action in combination with a sequence control in stepper design.

Contents

Part A – Exercises

Exercise 1: Pressing of cheese wheels	A-3
Exercise 2: Opening of an animal feed silo	A-11
Exercise 3: Testing of key blanks	A-17
Exercise 4: Sorting of packages	A-23
Exercise 5: Stopping crates of drinks	A-35
Exercise 6: Opening and closing of a pipe	A-41
Exercise 7: Shutting off using a quick shut-off function	A-47
Exercise 8: Actuation of a shut-off device	A-53
Exercise 9: Brushing of cheese wheels	A-61
Exercise 10: Clamping of a workpiece	A-67
Exercise 11: Actuation of a sliding door	A-75
Exercise 12: Feeding of workpieces	A-81
Exercise 13: Crushing of drinks cans	A-87
Exercise 14: Packaging of brochures	A-93
Exercise 15: Fitting of locking clips	A-99
Exercise 16: Labelling of paint pots	A-105
Exercise 17: Cleaning of workpieces	A-111
Exercise 18: Pressing in of lids	A-117

Contents

Exercise 1: Pressing of cheese wheels

- Training aims**
- To familiarise yourself with the design and mode of operation of a single-acting cylinder.
 - To familiarise yourself with the design and mode of operation of a 3/2-way valve.
 - To be able to identify and draw types of directional control valve actuation.
 - To be able to explain and design an example of direct actuation.
- Problem definition**
- During cheese production, pneumatic cylinders are to be used to press cheese wheels into moulds. Design the control system whereby this process can be carried out.
- Parameters**
- A single-acting cylinder is to be used .
 - The pneumatic control of the cylinder is to be realised by mean of a manually operated valve.
- Project task**
1. Describe the mode of operation of a single-acting cylinder.
 2. Describe the mode of operation of a 3/2-way valve.
 3. Complete the pneumatic circuit diagram for the pressing device.
 4. Carry out the assembly.
 5. Check the assembled circuit.
 6. Describe the mode of operation of the circuit.
 7. Compile an equipment list.

Exercise 1: Pressing of cheese wheels

Positional sketch



Cheese production

1. Cheese wheels are to be manually inserted into the device.
2. Actuation of the pushbutton is to cause the cylinder to advance and press the cover onto the device.
3. The pushbutton is to be pressed until the pressing operation is completed.
4. If the pushbutton is released, the cylinder is to retract again and release the device.
5. The wheel can then be removed.

Note

A single-acting cylinder with a strong reset spring must be used for this control system.



Safety advice

Please limit the pressure at the service unit to a maximum of 3.5 bar (350 kPa) for this exercise.

Exercise 1: Pressing of cheese wheels

Exercise 1: Pressing of cheese wheels	
Name:	Date:
Design and mode of operation of a single-acting cylinder	Sheet 1 of 2

- Compare the symbols shown with the schematic representation of the single-acting cylinder. Check whether these match.

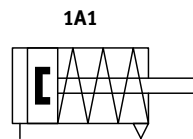

Symbol of a single-acting cylinder

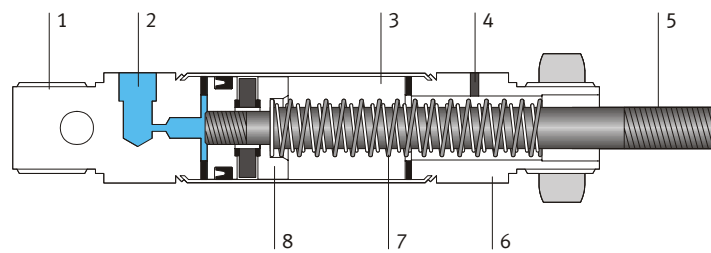

Schematic representation of a single-acting cylinder

- Assign the designations to the individual components.

No.	Description
	Cylinder barrel
	End cap
	Bearing cap
	Piston rod
	Piston
	Reset spring
	Supply port
	Exhaust port

Table of component designations

Exercise 1: Pressing of cheese wheels

Exercise 1: Pressing of cheese wheels	
Name:	Date:
Design and mode of operation of a single-acting cylinder	Sheet 2 of 2

The theoretical piston force is calculated according to the following formula:

$$F_{th} = A \cdot p$$

F_{th} = Theoretical piston force (N)
 A = Effective piston surface (m²)
 p = Working pressure (Pa)

The effective piston force is of significance in practice. Frictional resistance is to be taken into account when you calculate this. Friction forces of approx. 10% of the theoretical piston force can be assumed for standard operating conditions (pressure range of 4 to 8 bar (400 to 800 kPa)).

The following applies for single-acting cylinders:

$$F_{eff} = A \cdot p - (F_F + F_R)$$

F_{eff} = Effective piston force (N)
 F_F = Friction force (approx. 10% of F_{th}) (N)
 F_R = Return spring force (N)

- Calculate the effective piston force in the advance stroke for the cylinder when used at an operating pressure of 6 bar (600 kPa)!

Note

You will find information regarding the technical data in Chapter D and on the CD-ROM provided.

Exercise 1: Pressing of cheese wheels

Exercise 1: Pressing of cheese wheels	
Name:	Date:
Mode of operation of a 3/2-way valve.	Sheet 1 of 1

- Complete the symbol of a 3/2-way valve, manually operated, with spring return, normally closed.

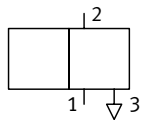

Symbol of a 3/2-way valve

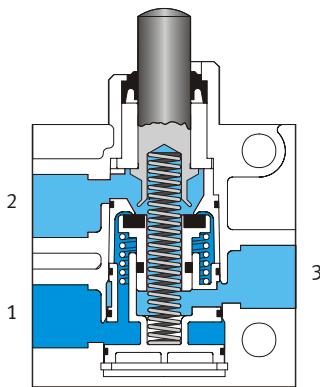

Schematic representation of a 3/2-way valve

- Explain the mode of operation of the 3/2-way valve.

Exercise 1: Pressing of cheese wheels

Exercise 1: Pressing of cheese wheels	
Name:	Date:
Completing the pneumatic circuit diagram	Sheet 1 of 1

- Complete the pneumatic circuit diagram for the device and enter the port designations.

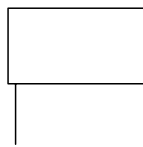

Pneumatic circuit diagram

Note

The Start-up valve with filter control valve and the manifold are not shown. These components are required for the circuit assembly.

Exercise 1: Pressing of cheese wheels

Exercise 1: Pressing of cheese wheels	
Name:	Date:
Compiling the equipment list	Sheet 1 of 1

Apart from the circuit diagram, comprehensive project documentation also requires an equipment list.

- Compile the equipment list by entering the required equipment in the table below.

Quantity	Description

Equipment list

Exercise 1: Pressing of cheese wheels